

**Volvo EW180**  
**Max Capacity Contours of Radius(m) Plots 2.0m Dipper**  
**Gradient 1 in -25 Height 2m Lift BP**  
**Unlocked Rail Cant -150mm**

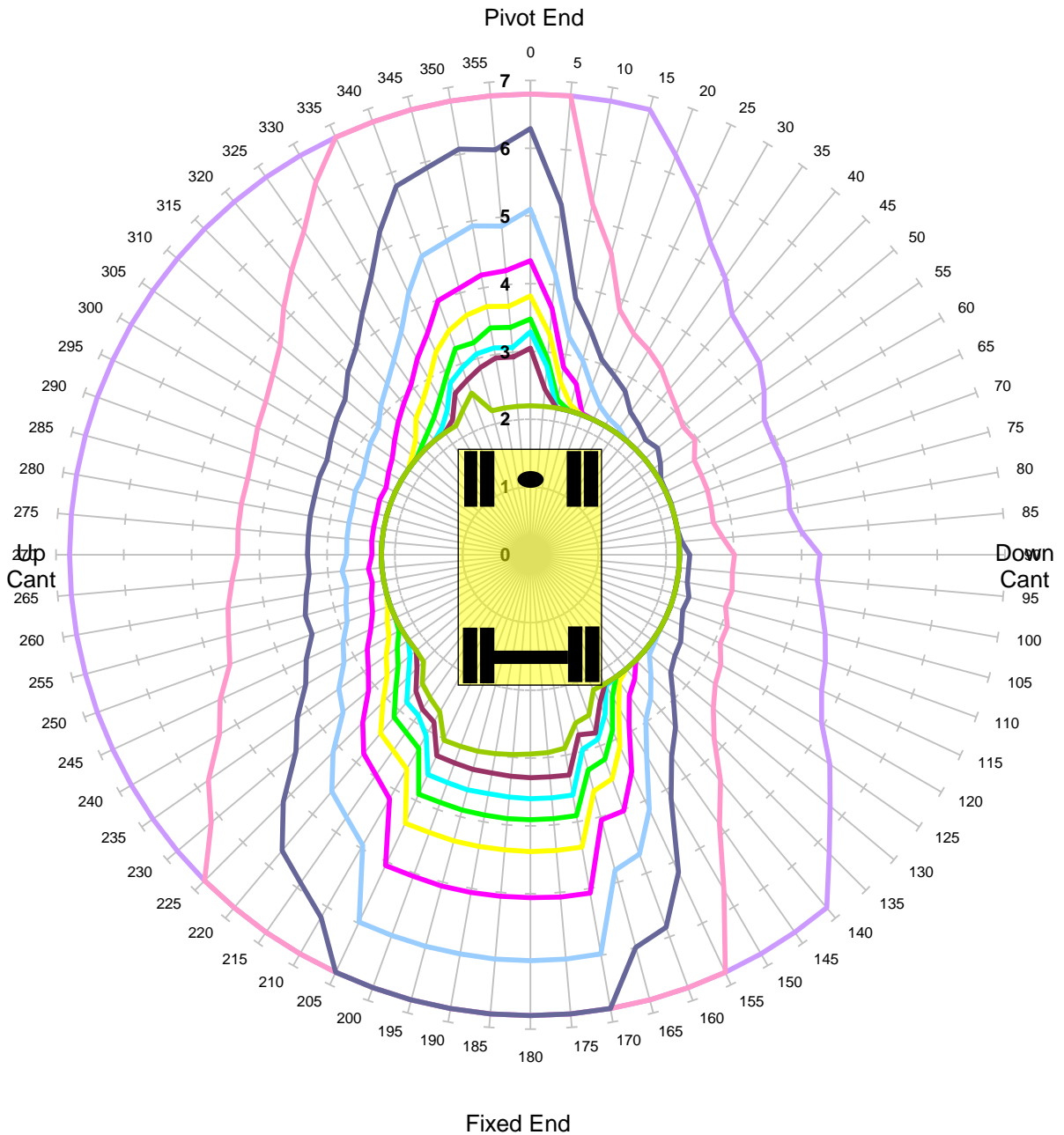

Units in Tonnes

- 1   
 — 2   
 — 3   
 — 4   
 — 5   
 — 6   
 — 7   
 — 8   
 — 9   
 — 10

<b>MACHINE &amp; MODEL:</b>	Volvo EW180	<b>REFERENCE:</b>	
<b>SERIAL No:</b>	8741011	<b>DATE OF CHART:</b>	4-Jun-2021
<b>EQUIPMENT:</b>	2.06m + 3.03m + 2.00m	<b>SAFETY FACTOR:</b>	67.0%
<b>COMMENT:</b>			

**Volvo EW180**  
**Max Capacity Contours of Radius(m) Plots 2.0m Dipper**  
**Gradient 1 in -25 Height 2m Lift BP**  
**Unlocked Rail Cant -50mm**

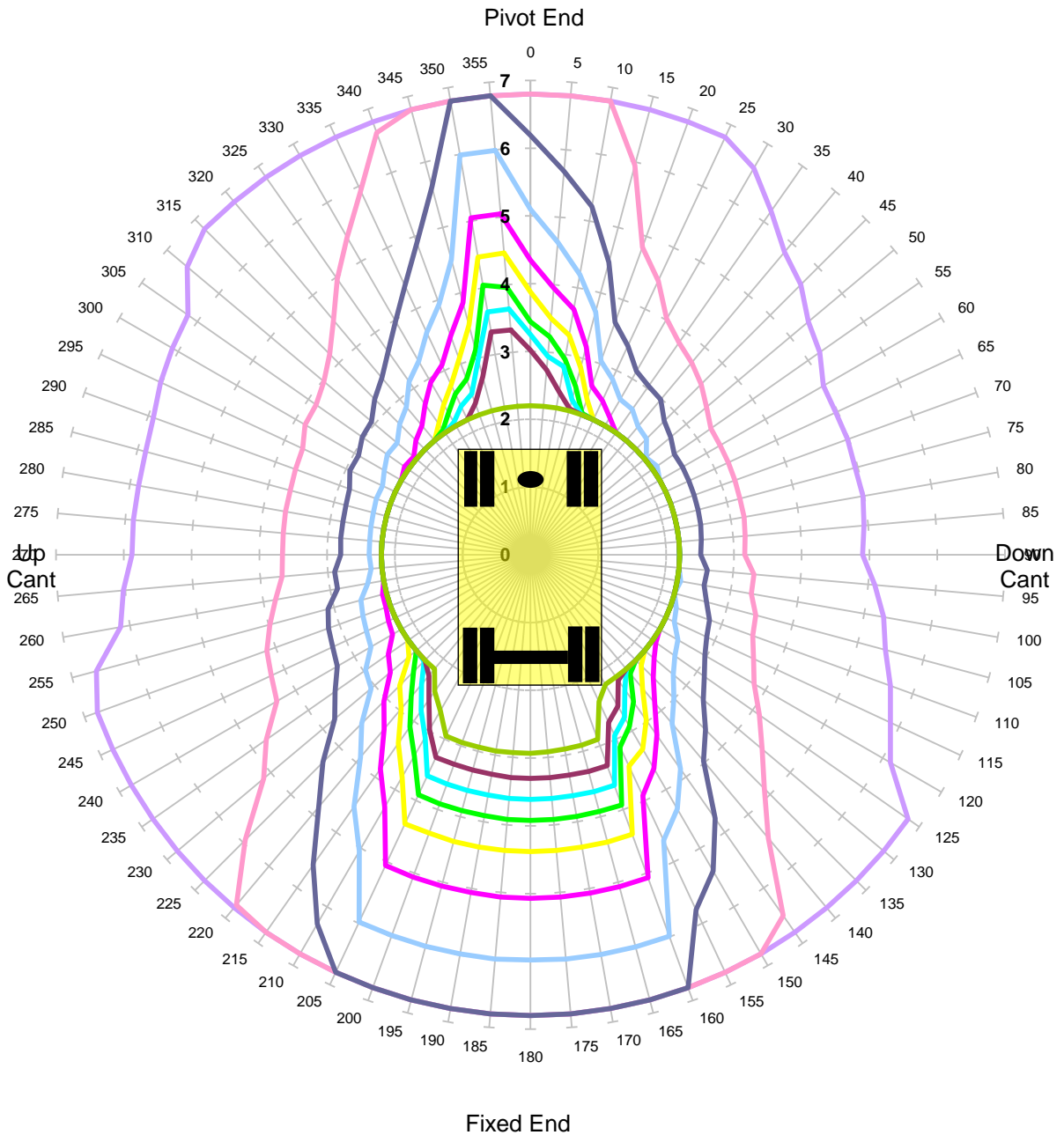

Units in Tonnes

- 1   
 — 2   
 — 3   
 — 4   
 — 5   
 — 6   
 — 7   
 — 8   
 — 9   
 — 10

<b>MACHINE &amp; MODEL:</b>	Volvo EW180	<b>REFERENCE:</b>	
<b>SERIAL No:</b>	8741011	<b>DATE OF CHART:</b>	4-Jun-2021
<b>EQUIPMENT:</b>	2.06m + 3.03m + 2.00m	<b>SAFETY FACTOR:</b>	67.0%
<b>COMMENT:</b>			

**Volvo EW180**  
**Max Capacity Contours of Radius(m) Plots 2.0m Dipper**  
**Gradient 1 in -25 Height 2m Lift BP**  
**Unlocked Rail Cant 50mm**

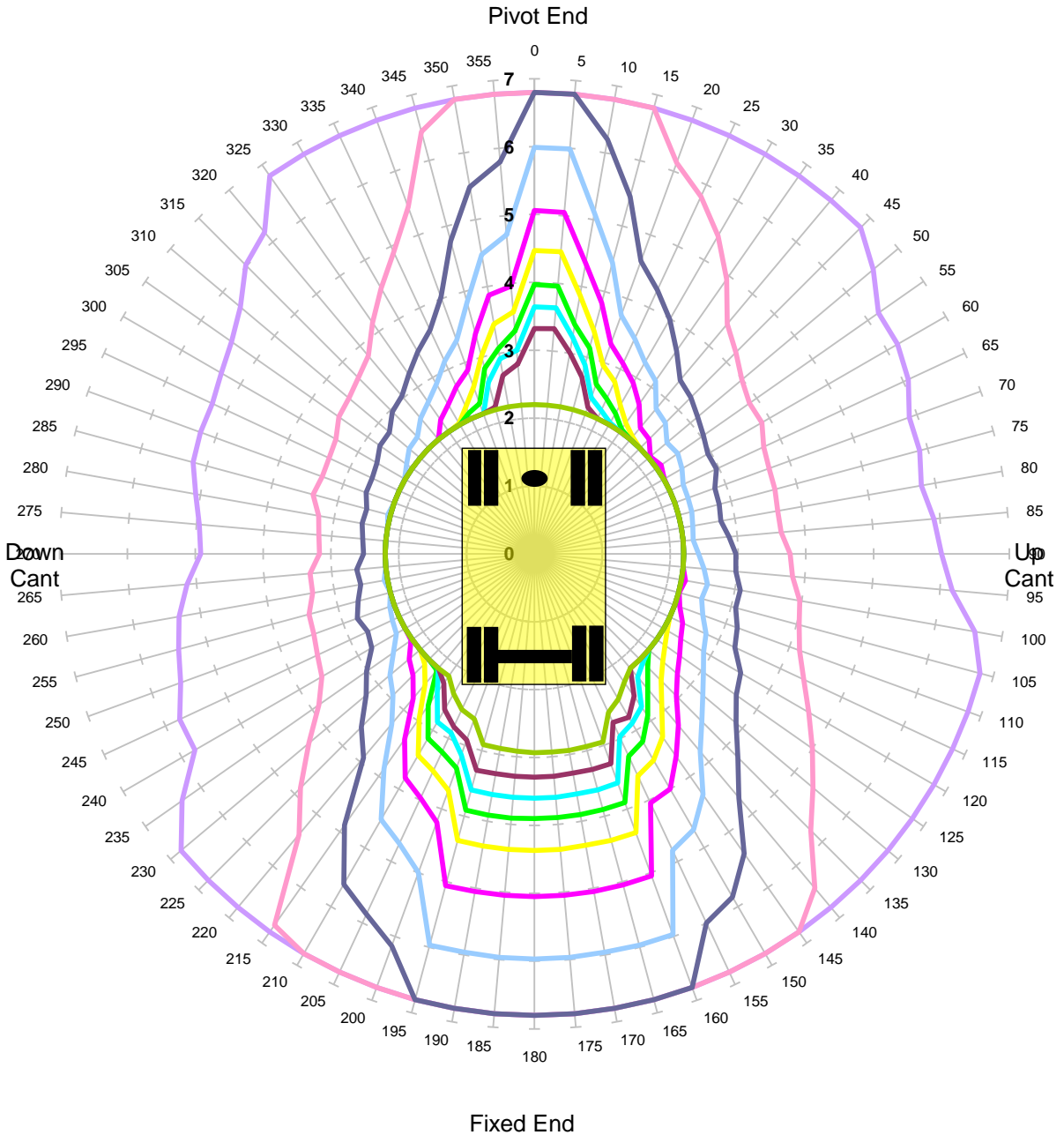

Units in Tonnes

- 1
- 2
- 3
- 4
- 5
- 6
- 7
- 8
- 9
- 10

<b>MACHINE &amp; MODEL:</b>	Volvo EW180	<b>REFERENCE:</b>	
<b>SERIAL No:</b>	8741011	<b>DATE OF CHART:</b>	4-Jun-2021
<b>EQUIPMENT:</b>	2.06m + 3.03m + 2.00m	<b>SAFETY FACTOR:</b>	67.0%
<b>COMMENT:</b>			

**Volvo EW180**  
**Max Capacity Contours of Radius(m) Plots 2.0m Dipper**  
**Gradient 1 in -25 Height 2m Lift BP**  
**Unlocked Rail Cant 150mm**

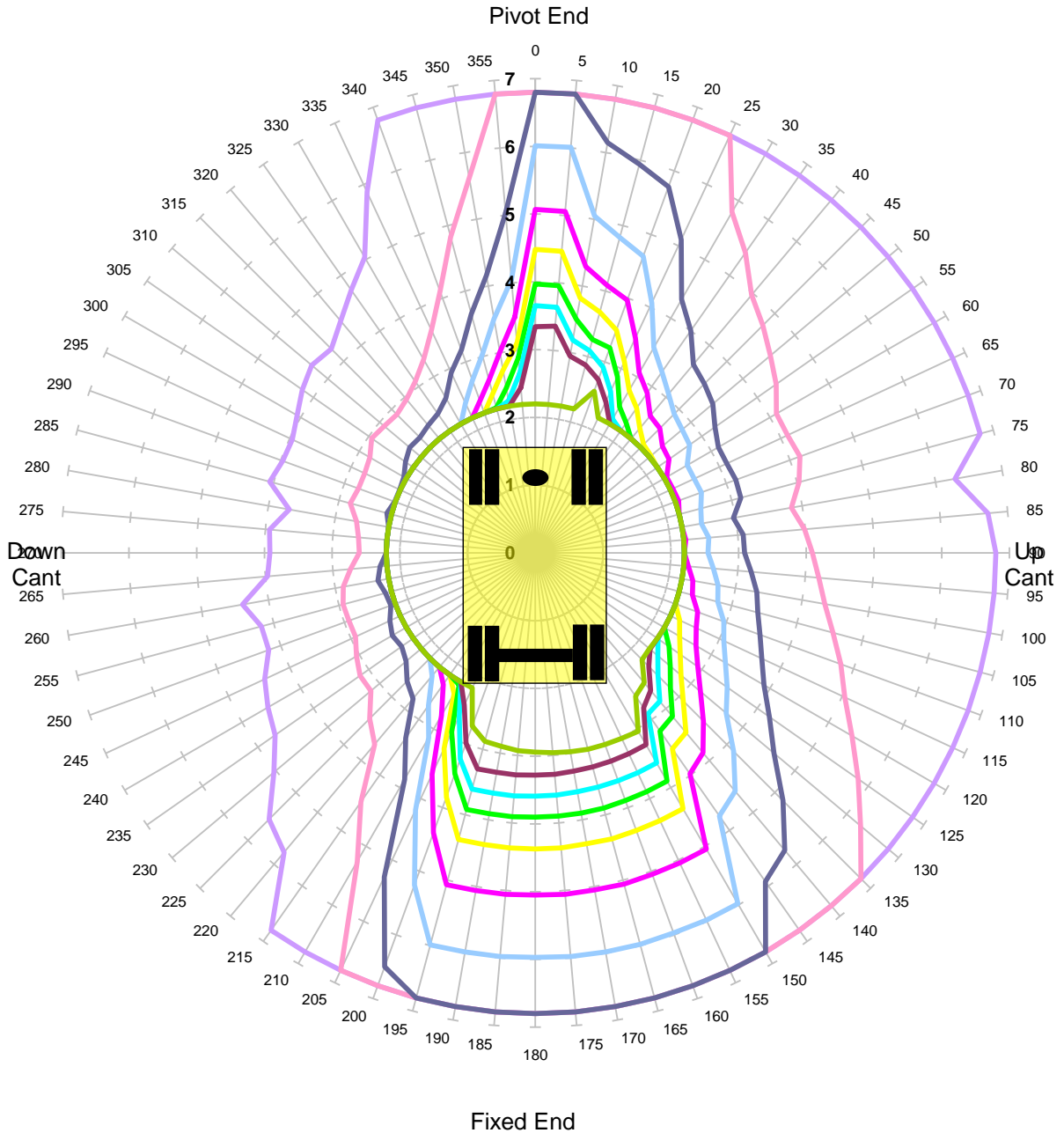

Units in Tonnes

- 1
- 2
- 3
- 4
- 5
- 6
- 7
- 8
- 9
- 10

<b>MACHINE &amp; MODEL:</b>	Volvo EW180	<b>REFERENCE:</b>	
<b>SERIAL No:</b>	8741011	<b>DATE OF CHART:</b>	4-Jun-2021
<b>EQUIPMENT:</b>	2.06m + 3.03m + 2.00m	<b>SAFETY FACTOR:</b>	67.0%
<b>COMMENT:</b>			

**Volvo EW180**  
**Max Capacity Contours of Radius(m) Plots 2.0m Dipper**  
**Gradient 1 in -25 Height 2m Lift BP**  
**Locked Rail Cant -150mm**

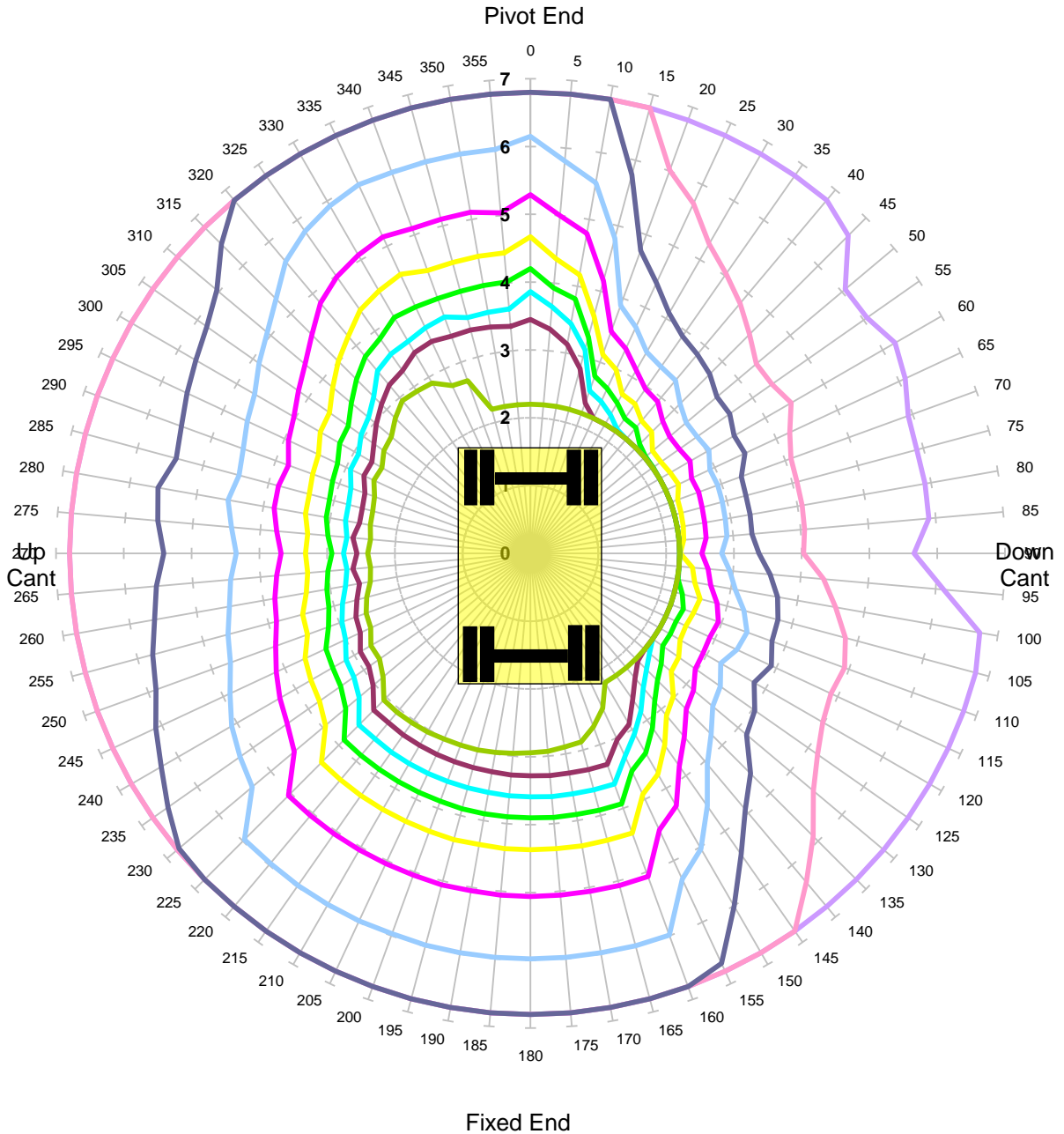

Units in Tonnes

- 1
- 2
- 3
- 4
- 5
- 6
- 7
- 8
- 9
- 10

<b>MACHINE &amp; MODEL:</b>	Volvo EW180	<b>REFERENCE:</b>	
<b>SERIAL No:</b>	8741011	<b>DATE OF CHART:</b>	4-Jun-2021
<b>EQUIPMENT:</b>	2.06m + 3.03m + 2.00m	<b>SAFETY FACTOR:</b>	90.0%
<b>COMMENT:</b>			

**Volvo EW180**  
**Max Capacity Contours of Radius(m) Plots 2.0m Dipper**  
**Gradient 1 in -25 Height 2m Lift BP**  
**Locked Rail Cant -50mm**

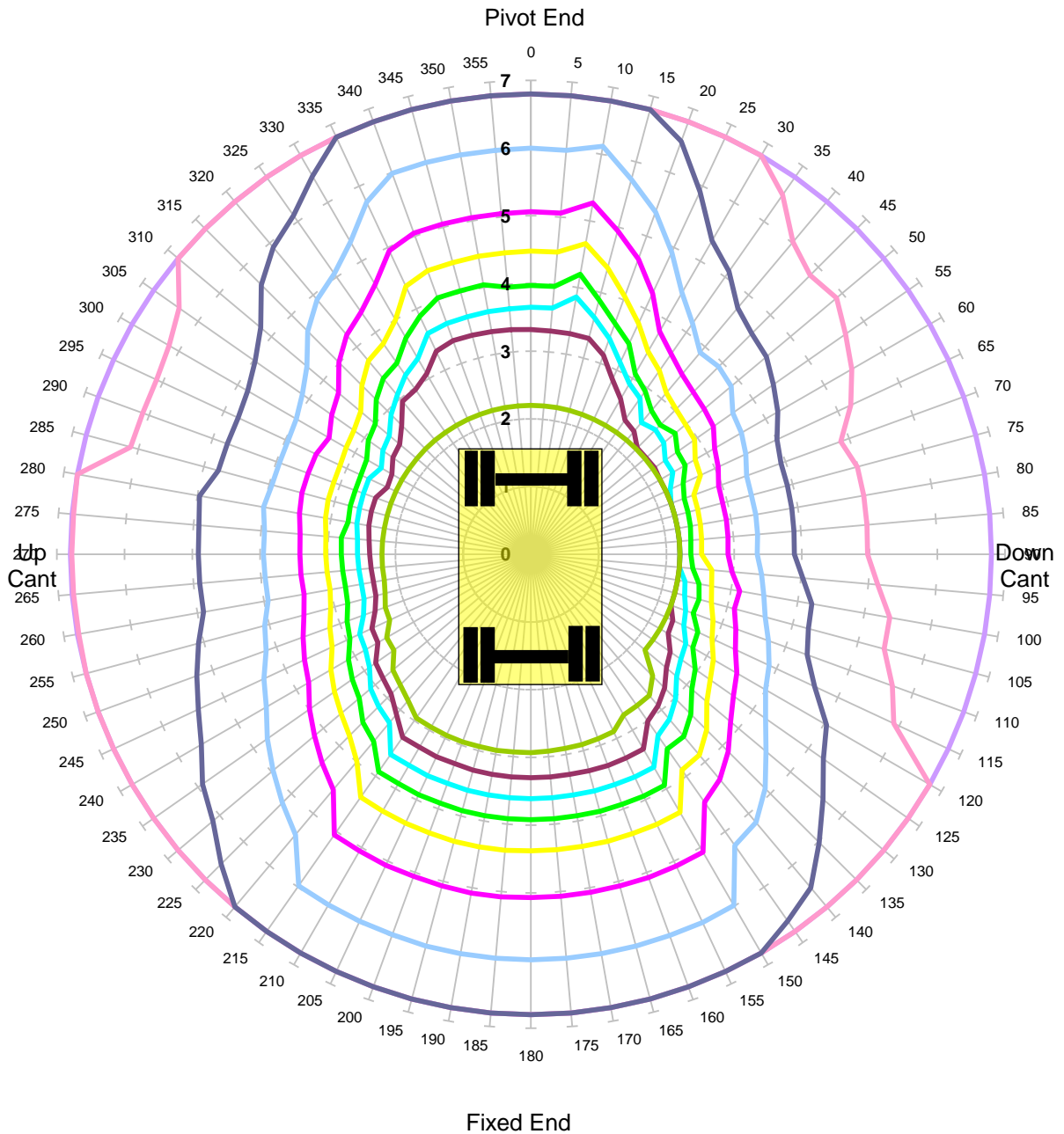

Units in Tonnes

- 1
- 2
- 3
- 4
- 5
- 6
- 7
- 8
- 9
- 10

<b>MACHINE &amp; MODEL:</b>	Volvo EW180	<b>REFERENCE:</b>	
<b>SERIAL No:</b>	8741011	<b>DATE OF CHART:</b>	4-Jun-2021
<b>EQUIPMENT:</b>	2.06m + 3.03m + 2.00m	<b>SAFETY FACTOR:</b>	90.0%
<b>COMMENT:</b>			

**Volvo EW180**  
**Max Capacity Contours of Radius(m) Plots 2.0m Dipper**  
**Gradient 1 in -25 Height 2m Lift BP**  
**Locked Rail Cant 50mm**

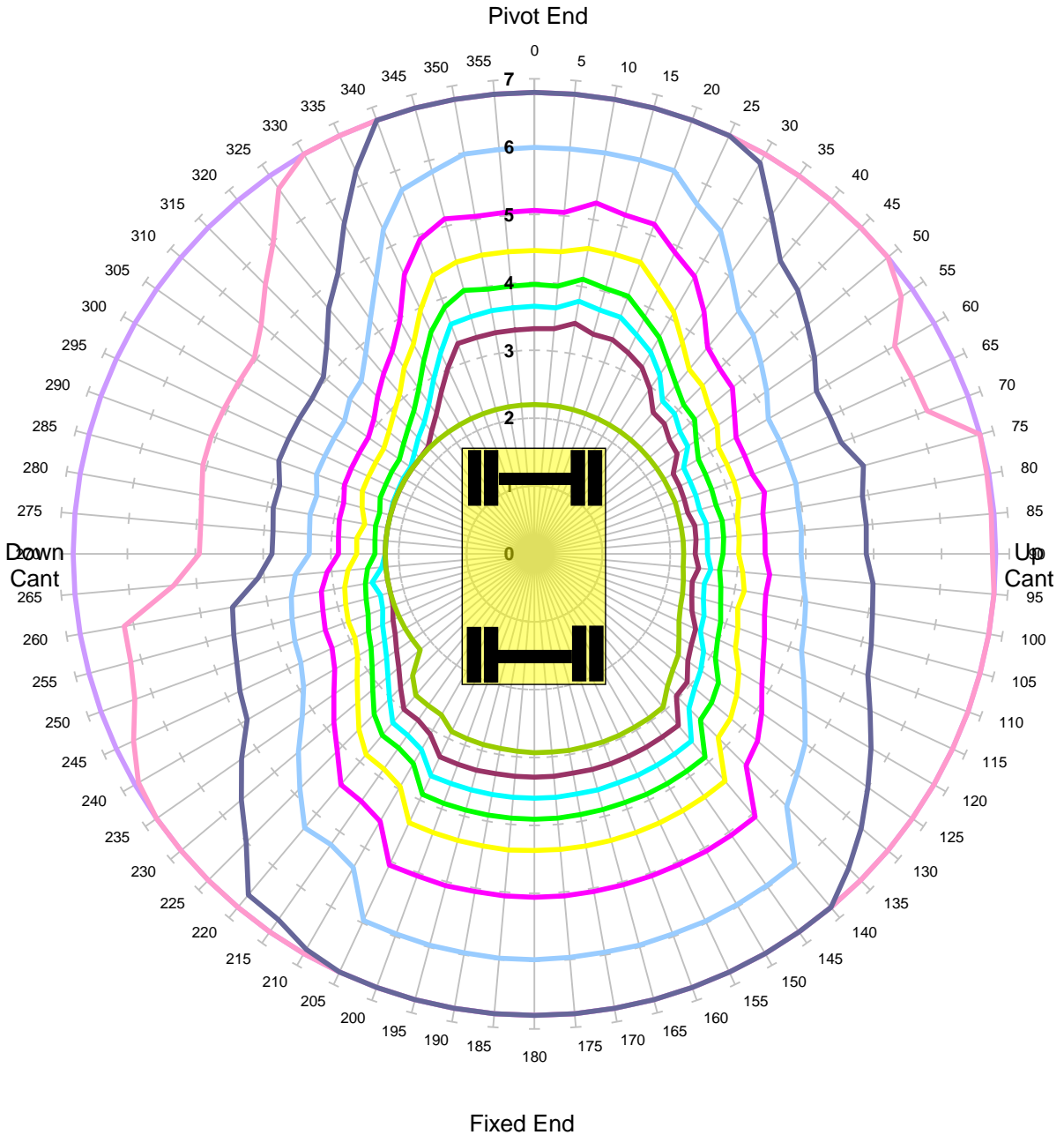

Units in Tonnes

- 1
- 2
- 3
- 4
- 5
- 6
- 7
- 8
- 9
- 10

<b>MACHINE &amp; MODEL:</b>	Volvo EW180	<b>REFERENCE:</b>	
<b>SERIAL No:</b>	8741011	<b>DATE OF CHART:</b>	4-Jun-2021
<b>EQUIPMENT:</b>	2.06m + 3.03m + 2.00m	<b>SAFETY FACTOR:</b>	90.0%
<b>COMMENT:</b>			

**Volvo EW180**  
**Max Capacity Contours of Radius(m) Plots 2.0m Dipper**  
**Gradient 1 in -25 Height 2m Lift BP**  
**Locked Rail Cant 150mm**

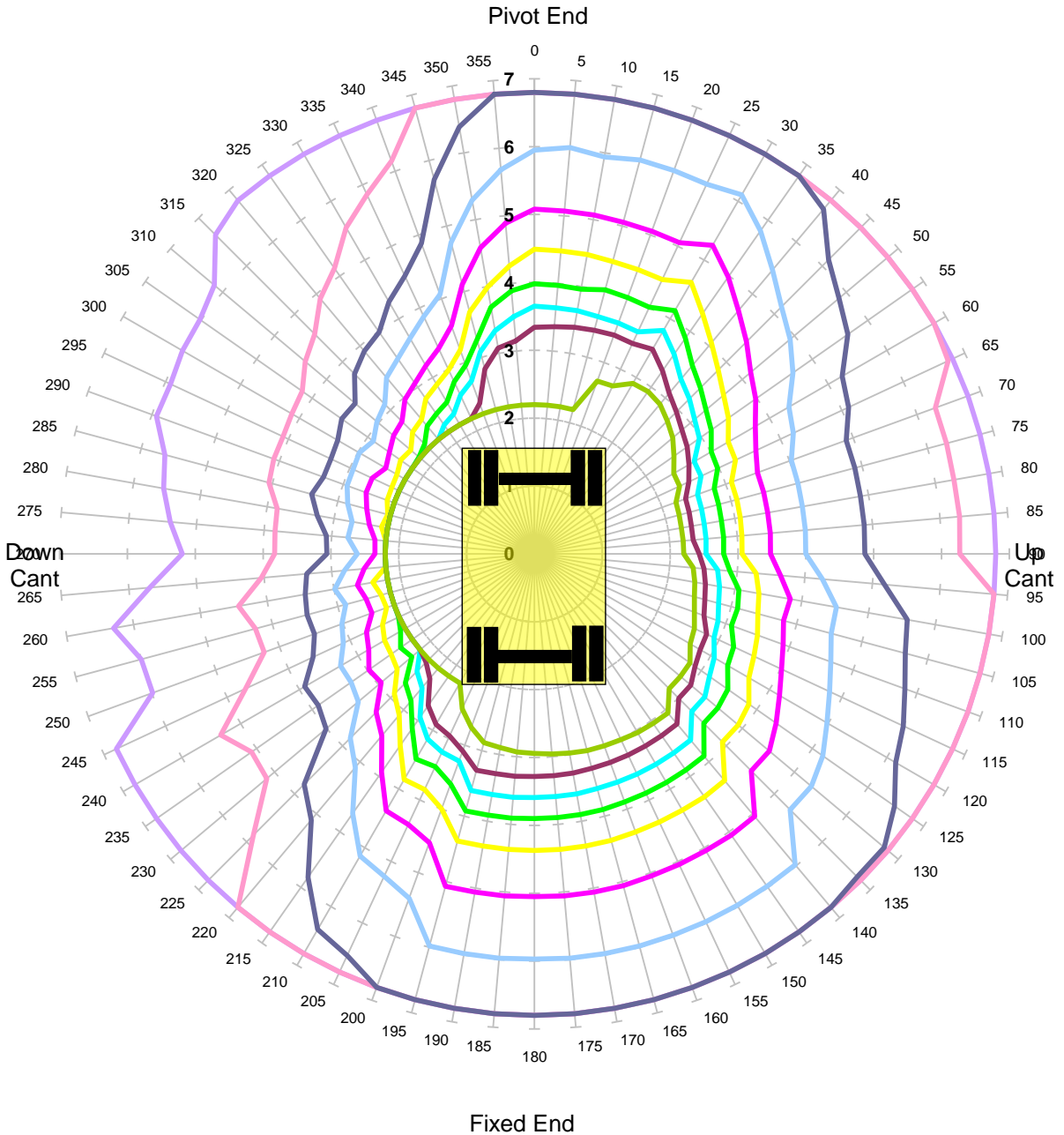

Units in Tonnes

- 1
- 2
- 3
- 4
- 5
- 6
- 7
- 8
- 9
- 10

<b>MACHINE &amp; MODEL:</b>	Volvo EW180	<b>REFERENCE:</b>	
<b>SERIAL No:</b>	8741011	<b>DATE OF CHART:</b>	4-Jun-2021
<b>EQUIPMENT:</b>	2.06m + 3.03m + 2.00m	<b>SAFETY FACTOR:</b>	90.0%
<b>COMMENT:</b>			



**Volvo EW180**  
**Max Capacity Contours of Radius(m) Plots 2.0m Dipper**  
**Level Ground Height 2m Lift BP**  
**Unlocked Road**

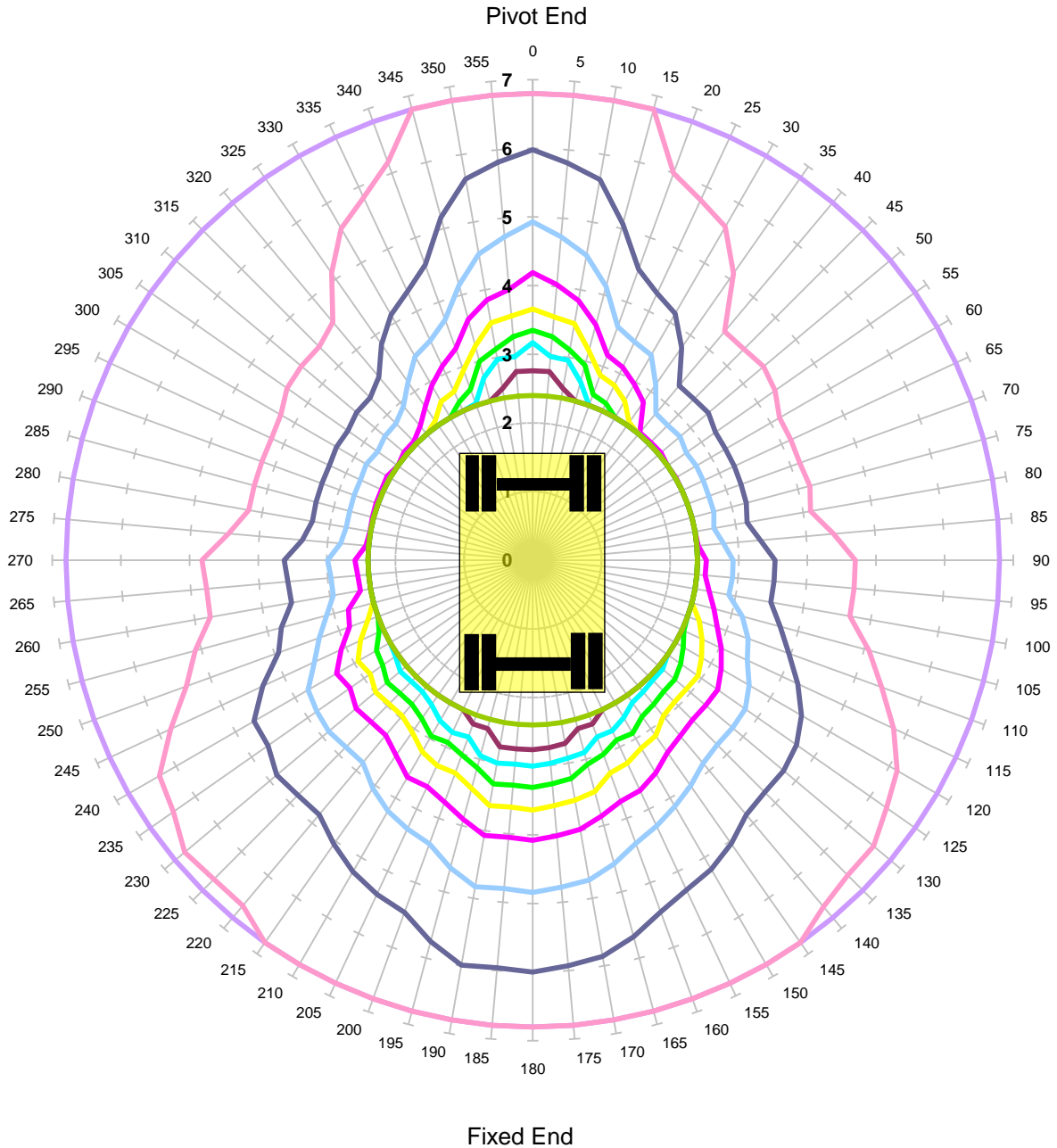

Units in Tonnes

- 1
- 2
- 3
- 4
- 5
- 6
- 7
- 8
- 9
- 10

<b>MACHINE &amp; MODEL:</b>	Volvo EW180	<b>REFERENCE:</b>	
<b>SERIAL No:</b>	8741011	<b>DATE OF CHART:</b>	4-Jun-2021
<b>EQUIPMENT:</b>	2.06m + 3.03m + 2.00m	<b>SAFETY FACTOR:</b>	71.0%
<b>COMMENT:</b>			

**Volvo EW180**  
**Max Capacity Contours of Radius(m) Plots 2.0m Dipper**  
**Level Ground Height 2m Lift BP**  
**Locked Road**

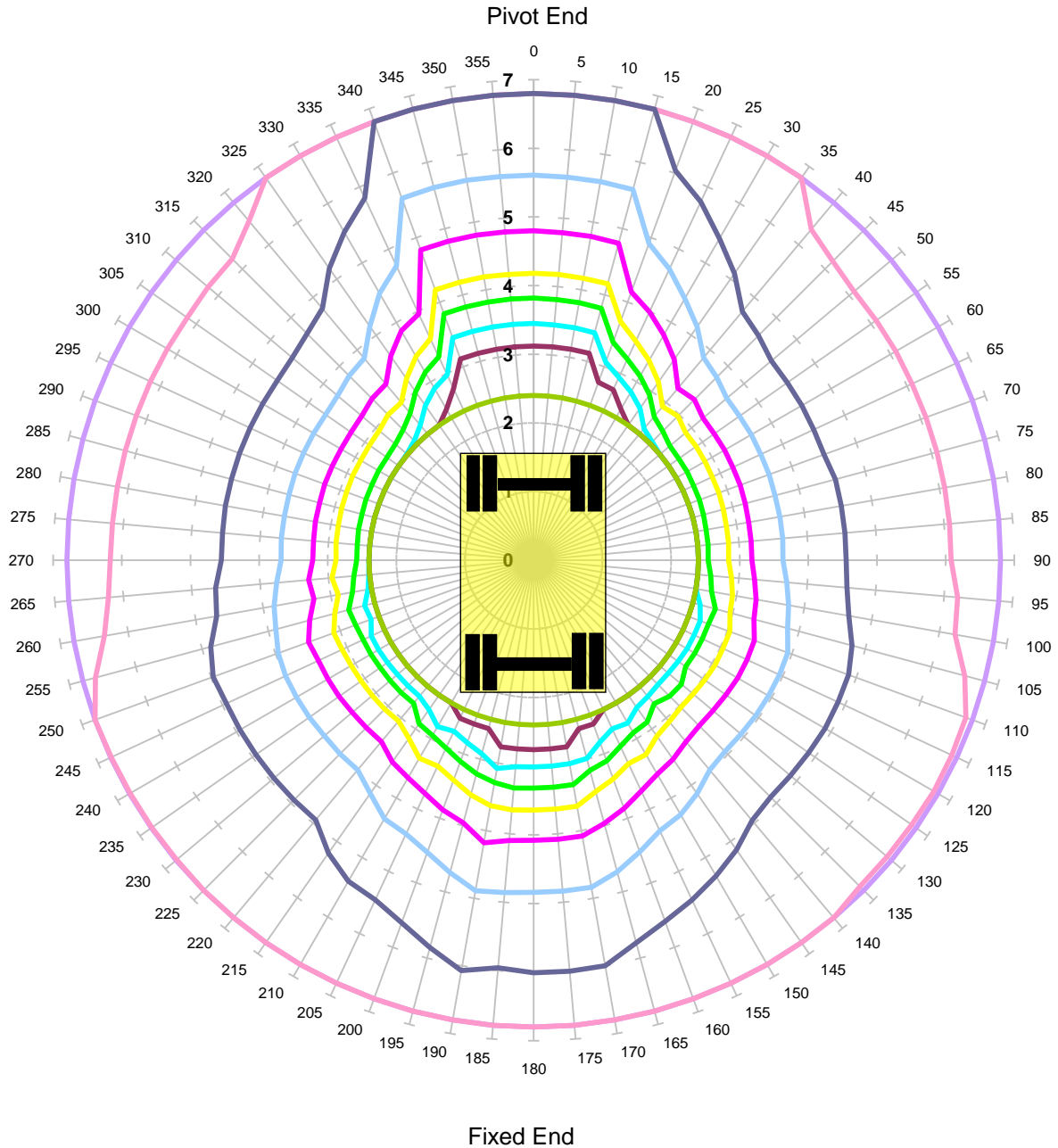

Units in Tonnes

- 1
- 2
- 3
- 4
- 5
- 6
- 7
- 8
- 9
- 10

<b>MACHINE &amp; MODEL:</b>	Volvo EW180	<b>REFERENCE:</b>	
<b>SERIAL No:</b>	8741011	<b>DATE OF CHART:</b>	4-Jun-2021
<b>EQUIPMENT:</b>	2.06m + 3.03m + 2.00m	<b>SAFETY FACTOR:</b>	71.0%
<b>COMMENT:</b>			

**Volvo EW180**  
**Max Capacity Contours of Radius(m) Plots 2.0m Dipper**  
**Gradient 1 in -25 Height 2m Lift BP**  
**Unlocked Rail Cant -150mm - Tandem Lift**

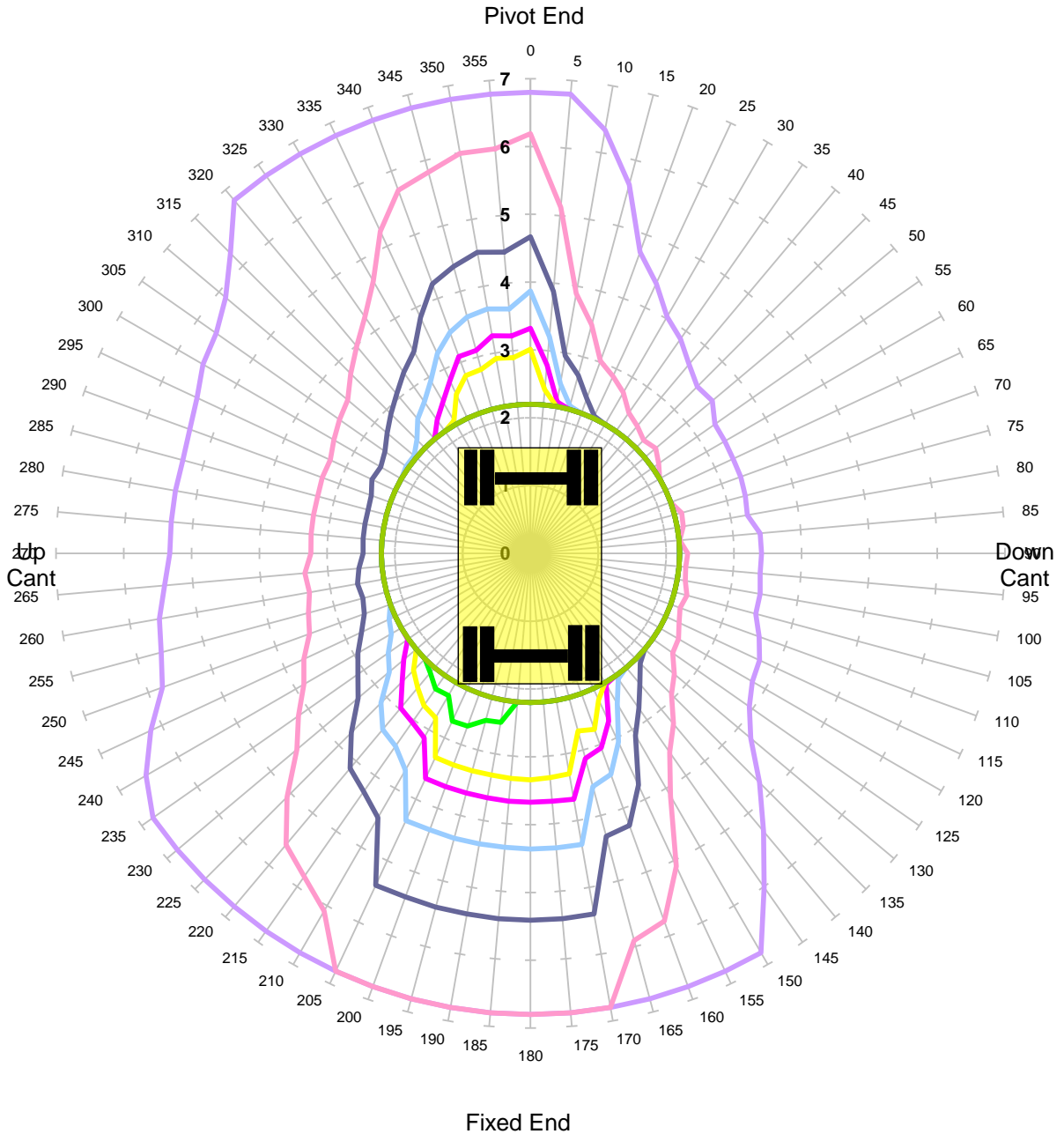

Units in Tonnes

- 1   
 — 2   
 — 3   
 — 4   
 — 5   
 — 6   
 — 7   
 — 8   
 — 9   
 — 10

<b>MACHINE &amp; MODEL:</b>	Volvo EW180	<b>REFERENCE:</b>	
<b>SERIAL No:</b>	8741011	<b>DATE OF CHART:</b>	4-Jun-2021
<b>EQUIPMENT:</b>	2.06m + 3.03m + 2.00m	<b>SAFETY FACTOR:</b>	44.0%
<b>COMMENT:</b>			

**Volvo EW180**  
**Max Capacity Contours of Radius(m) Plots 2.0m Dipper**  
**Gradient 1 in -25 Height 2m Lift BP**  
**Unlocked Rail Cant -50mm - Tandem Lift**

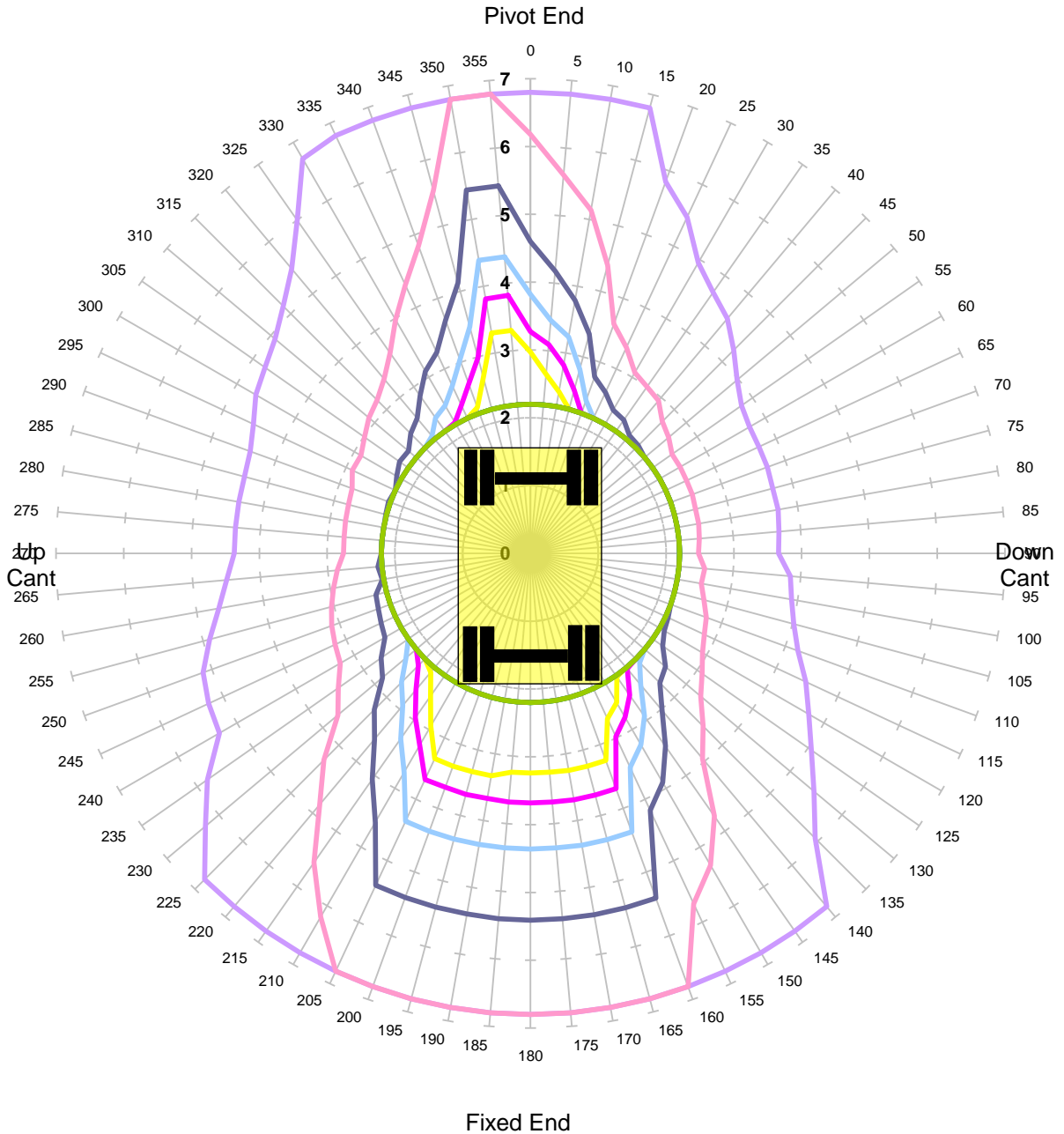

Units in Tonnes

- 1   
 — 2   
 — 3   
 — 4   
 — 5   
 — 6   
 — 7   
 — 8   
 — 9   
 — 10

<b>MACHINE &amp; MODEL:</b>	Volvo EW180	<b>REFERENCE:</b>	
<b>SERIAL No:</b>	8741011	<b>DATE OF CHART:</b>	4-Jun-2021
<b>EQUIPMENT:</b>	2.06m + 3.03m + 2.00m	<b>SAFETY FACTOR:</b>	44.0%
<b>COMMENT:</b>			

**Volvo EW180**  
**Max Capacity Contours of Radius(m) Plots 2.0m Dipper**  
**Gradient 1 in -25 Height 2m Lift BP**  
**Unlocked Rail Cant 50mm - Tandem Lift**

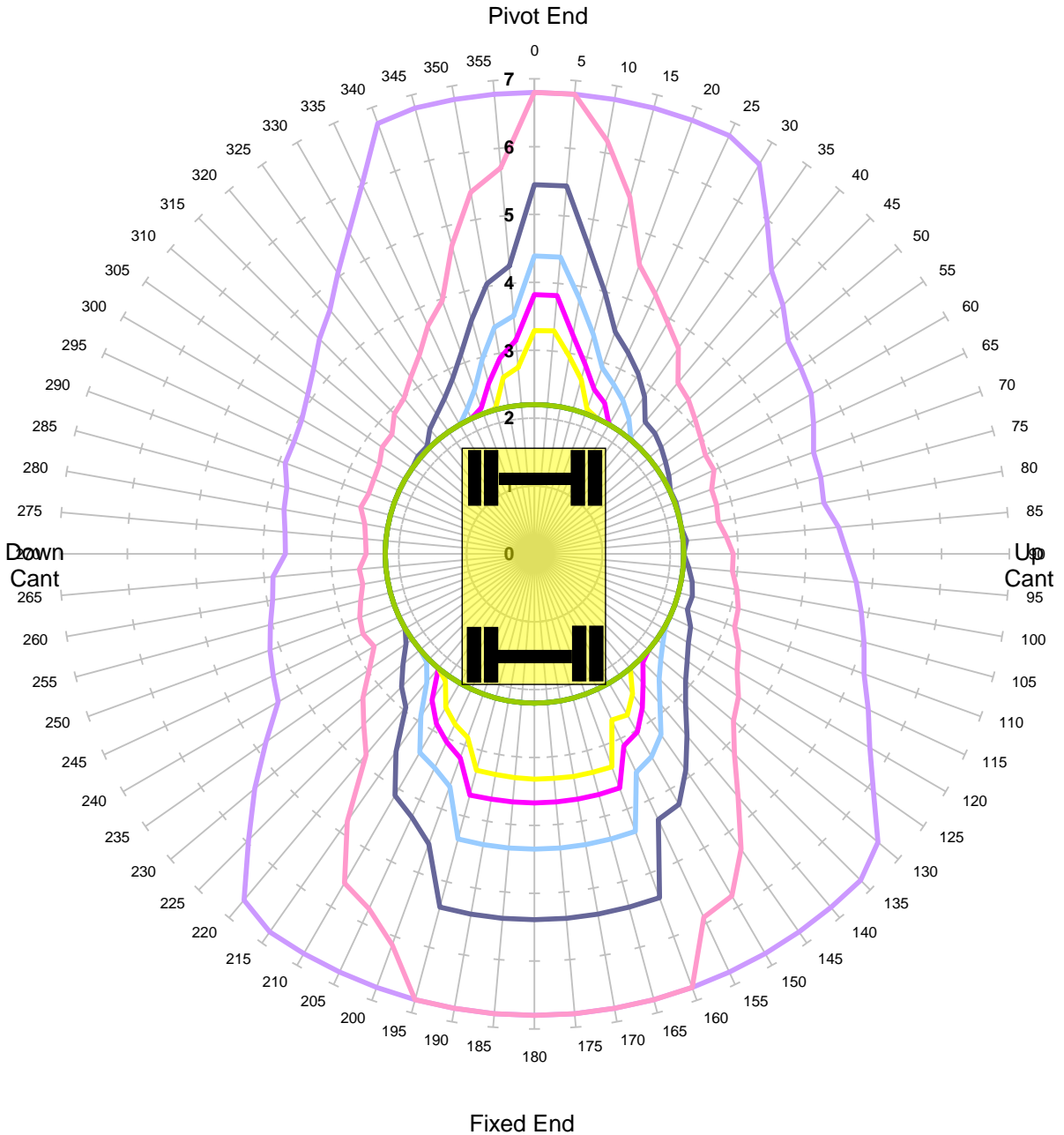

Units in Tonnes

- 1
- 2
- 3
- 4
- 5
- 6
- 7
- 8
- 9
- 10

<b>MACHINE &amp; MODEL:</b>	Volvo EW180	<b>REFERENCE:</b>	
<b>SERIAL No:</b>	8741011	<b>DATE OF CHART:</b>	4-Jun-2021
<b>EQUIPMENT:</b>	2.06m + 3.03m + 2.00m	<b>SAFETY FACTOR:</b>	44.0%
<b>COMMENT:</b>			

**Volvo EW180**  
**Max Capacity Contours of Radius(m) Plots 2.0m Dipper**  
**Gradient 1 in -25 Height 2m Lift BP**  
**Unlocked Rail Cant 150mm - Tandem Lift**

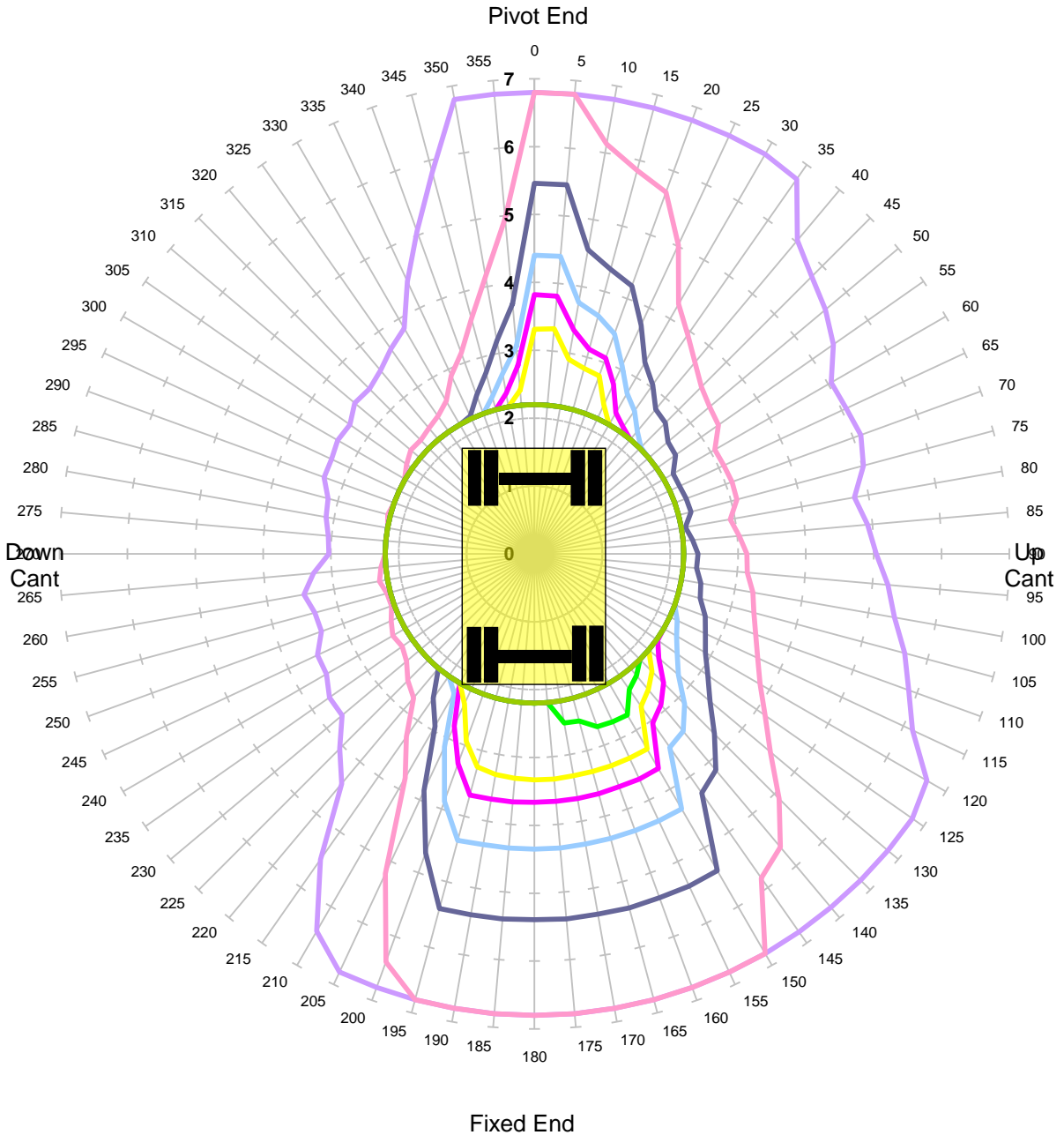

Units in Tonnes

- 1   
 — 2   
 — 3   
 — 4   
 — 5   
 — 6   
 — 7   
 — 8   
 — 9   
 — 10

<b>MACHINE &amp; MODEL:</b>	Volvo EW180	<b>REFERENCE:</b>	
<b>SERIAL No:</b>	8741011	<b>DATE OF CHART:</b>	4-Jun-2021
<b>EQUIPMENT:</b>	2.06m + 3.03m + 2.00m	<b>SAFETY FACTOR:</b>	44.0%
<b>COMMENT:</b>			

**Volvo EW180**  
**Max Capacity Contours of Radius(m) Plots 2.0m Dipper**  
**Gradient 1 in -25 Height 2m Lift BP**  
**Locked Rail Cant -150mm - Tandem Lift**

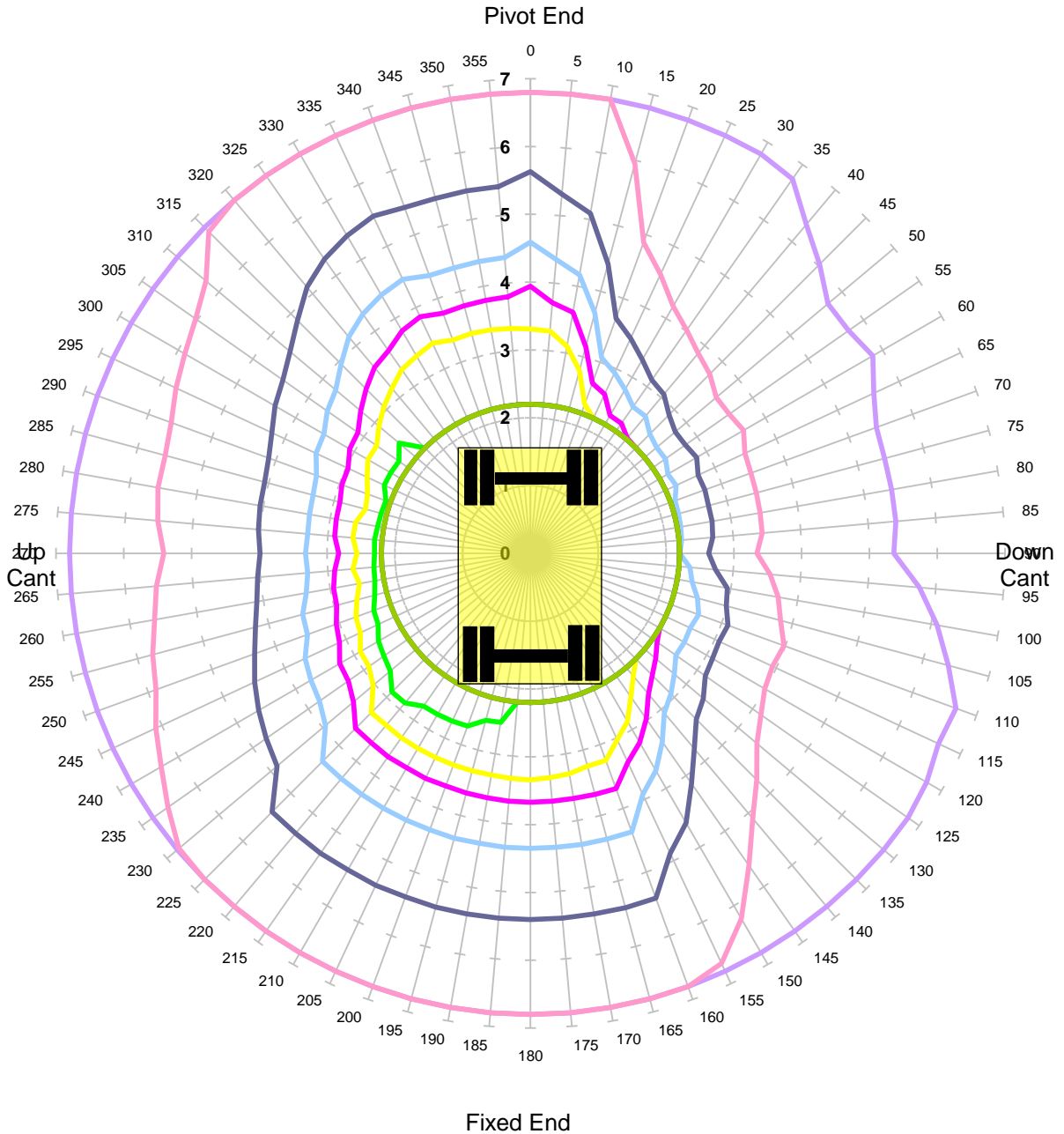

Units in Tonnes

- 1   
 — 2   
 — 3   
 — 4   
 — 5   
 — 6   
 — 7   
 — 8   
 — 9   
 — 10

<b>MACHINE &amp; MODEL:</b>	Volvo EW180	<b>REFERENCE:</b>	
<b>SERIAL No:</b>	8741011	<b>DATE OF CHART:</b>	4-Jun-2021
<b>EQUIPMENT:</b>	2.06m + 3.03m + 2.00m	<b>SAFETY FACTOR:</b>	59.0%
<b>COMMENT:</b>			

**Volvo EW180**  
**Max Capacity Contours of Radius(m) Plots 2.0m Dipper**  
**Gradient 1 in -25 Height 2m Lift BP**  
**Locked Rail Cant -50mm - Tandem Lift**

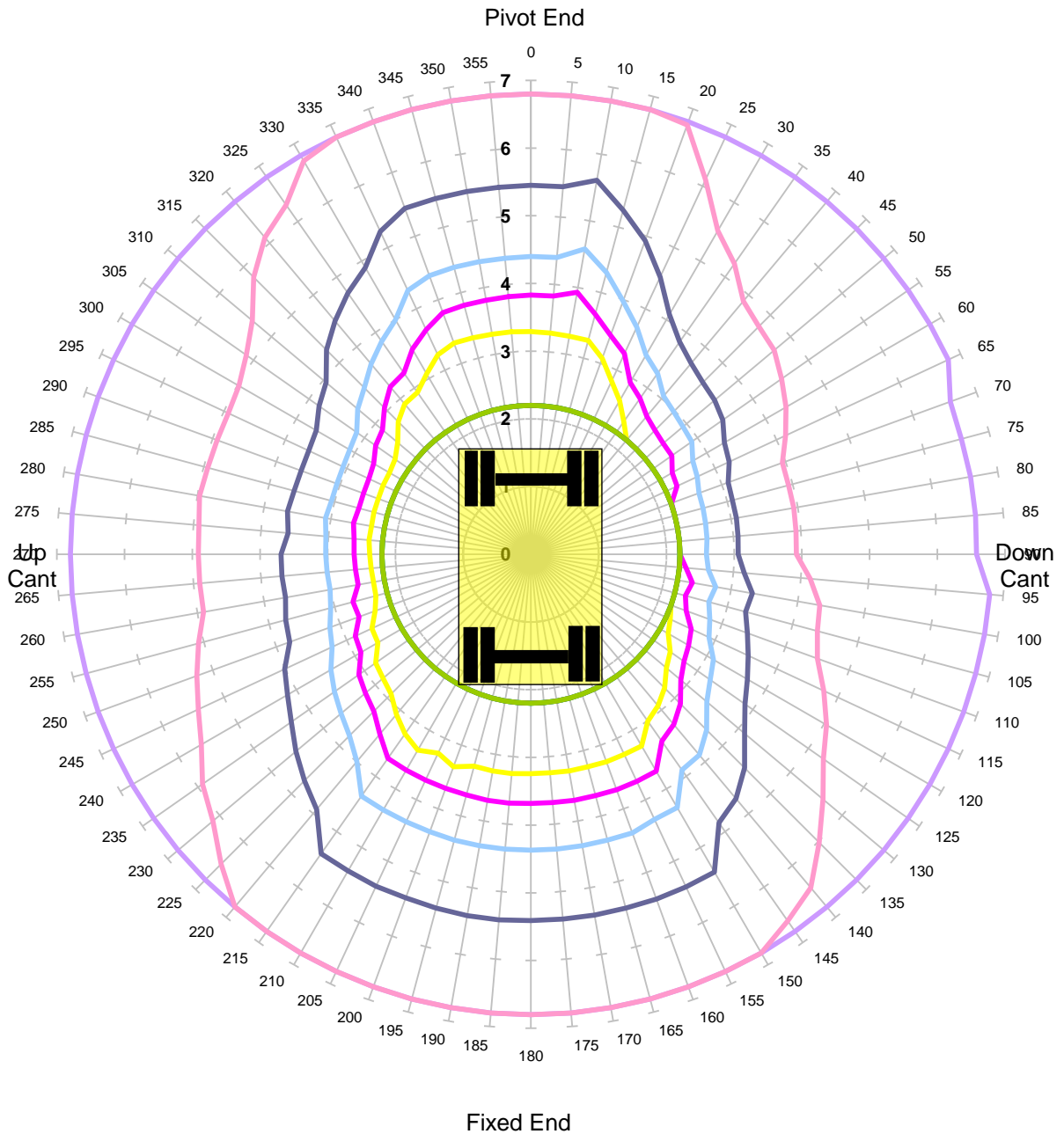

Units in Tonnes

- 1   
 — 2   
 — 3   
 — 4   
 — 5   
 — 6   
 — 7   
 — 8   
 — 9   
 — 10

<b>MACHINE &amp; MODEL:</b>	Volvo EW180	<b>REFERENCE:</b>	
<b>SERIAL No:</b>	8741011	<b>DATE OF CHART:</b>	4-Jun-2021
<b>EQUIPMENT:</b>	2.06m + 3.03m + 2.00m	<b>SAFETY FACTOR:</b>	59.0%
<b>COMMENT:</b>			



**Volvo EW180**  
**Max Capacity Contours of Radius(m) Plots 2.0m Dipper**  
**Gradient 1 in -25 Height 2m Lift BP**  
**Locked Rail Cant 50mm - Tandem Lift**

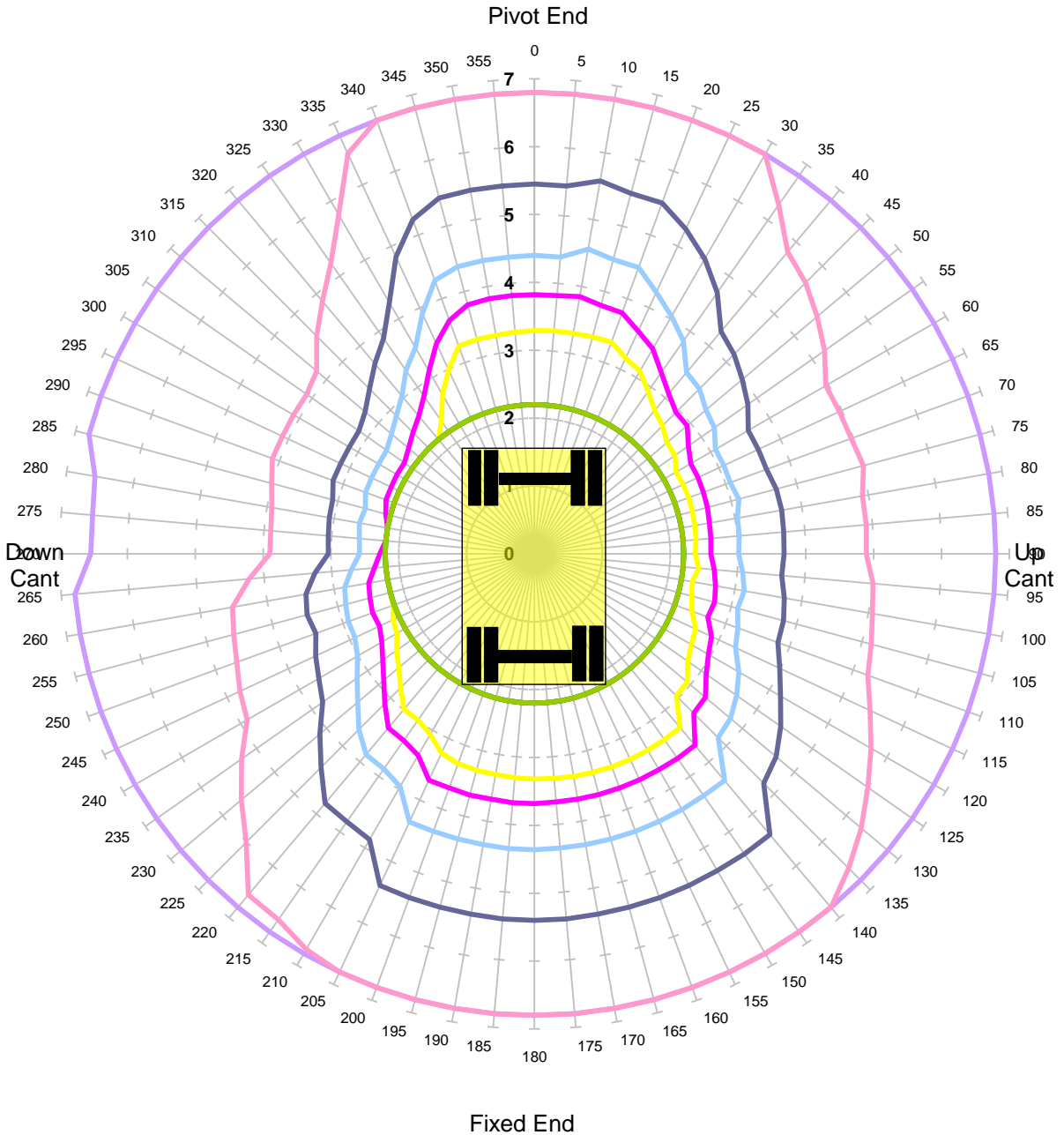

Units in Tonnes

- 1
- 2
- 3
- 4
- 5
- 6
- 7
- 8
- 9
- 10

<b>MACHINE &amp; MODEL:</b>	Volvo EW180	<b>REFERENCE:</b>	
<b>SERIAL No:</b>	8741011	<b>DATE OF CHART:</b>	4-Jun-2021
<b>EQUIPMENT:</b>	2.06m + 3.03m + 2.00m	<b>SAFETY FACTOR:</b>	59.0%
<b>COMMENT:</b>			

**Volvo EW180**  
**Max Capacity Contours of Radius(m) Plots 2.0m Dipper**  
**Gradient 1 in -25 Height 2m Lift BP**  
**Locked Rail Cant 150mm - Tandem Lift**

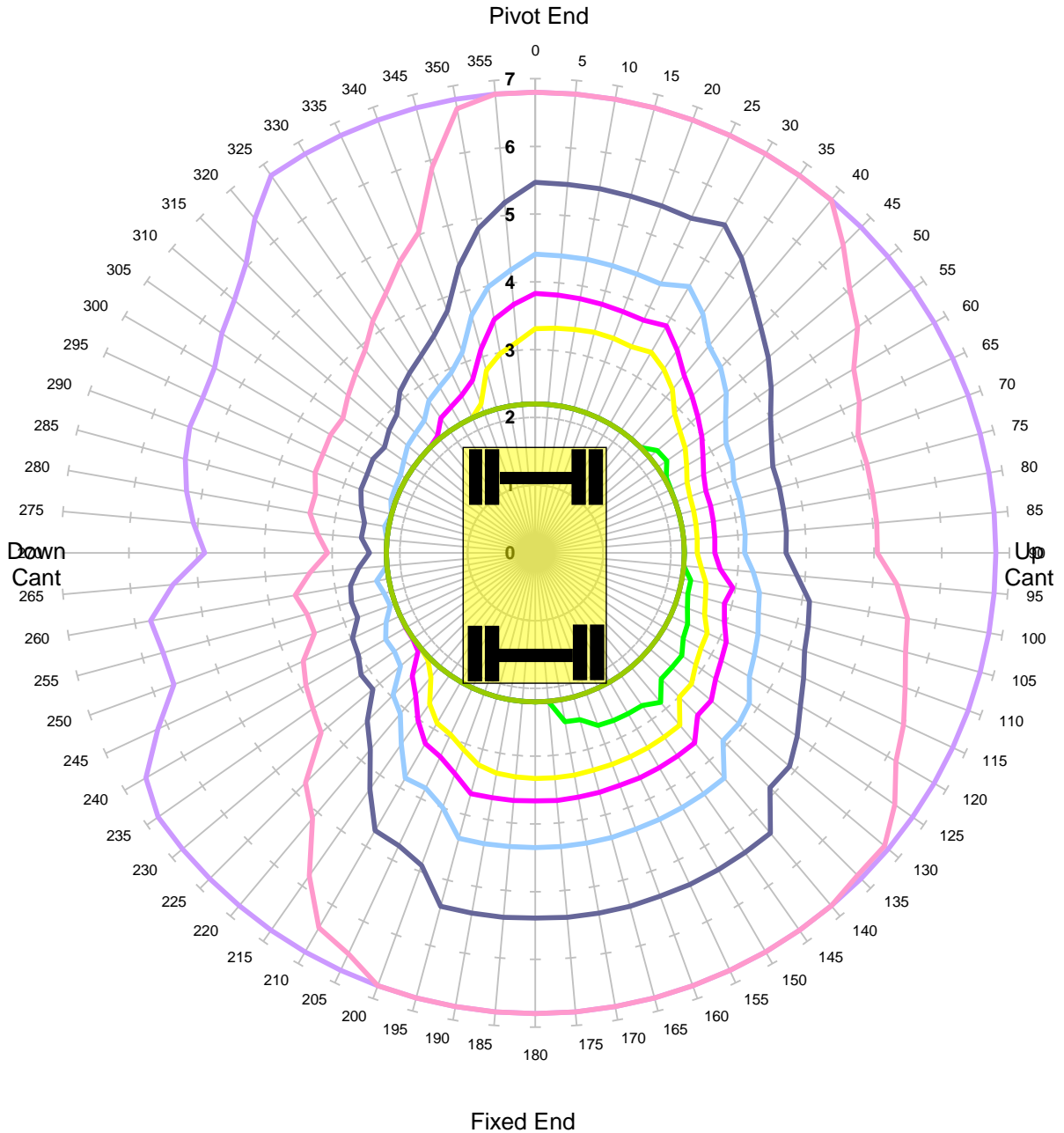

Units in Tonnes

- 1   
 — 2   
 — 3   
 — 4   
 — 5   
 — 6   
 — 7   
 — 8   
 — 9   
 — 10

<b>MACHINE &amp; MODEL:</b>	Volvo EW180	<b>REFERENCE:</b>	
<b>SERIAL No:</b>	8741011	<b>DATE OF CHART:</b>	4-Jun-2021
<b>EQUIPMENT:</b>	2.06m + 3.03m + 2.00m	<b>SAFETY FACTOR:</b>	59.0%
<b>COMMENT:</b>			

**Volvo EW180**  
**Max Capacity Contours of Radius(m) Plots 2.0m Dipper**  
**Level Ground Height 2m Lift BP**  
**Unlocked Road - Tandem Lift**

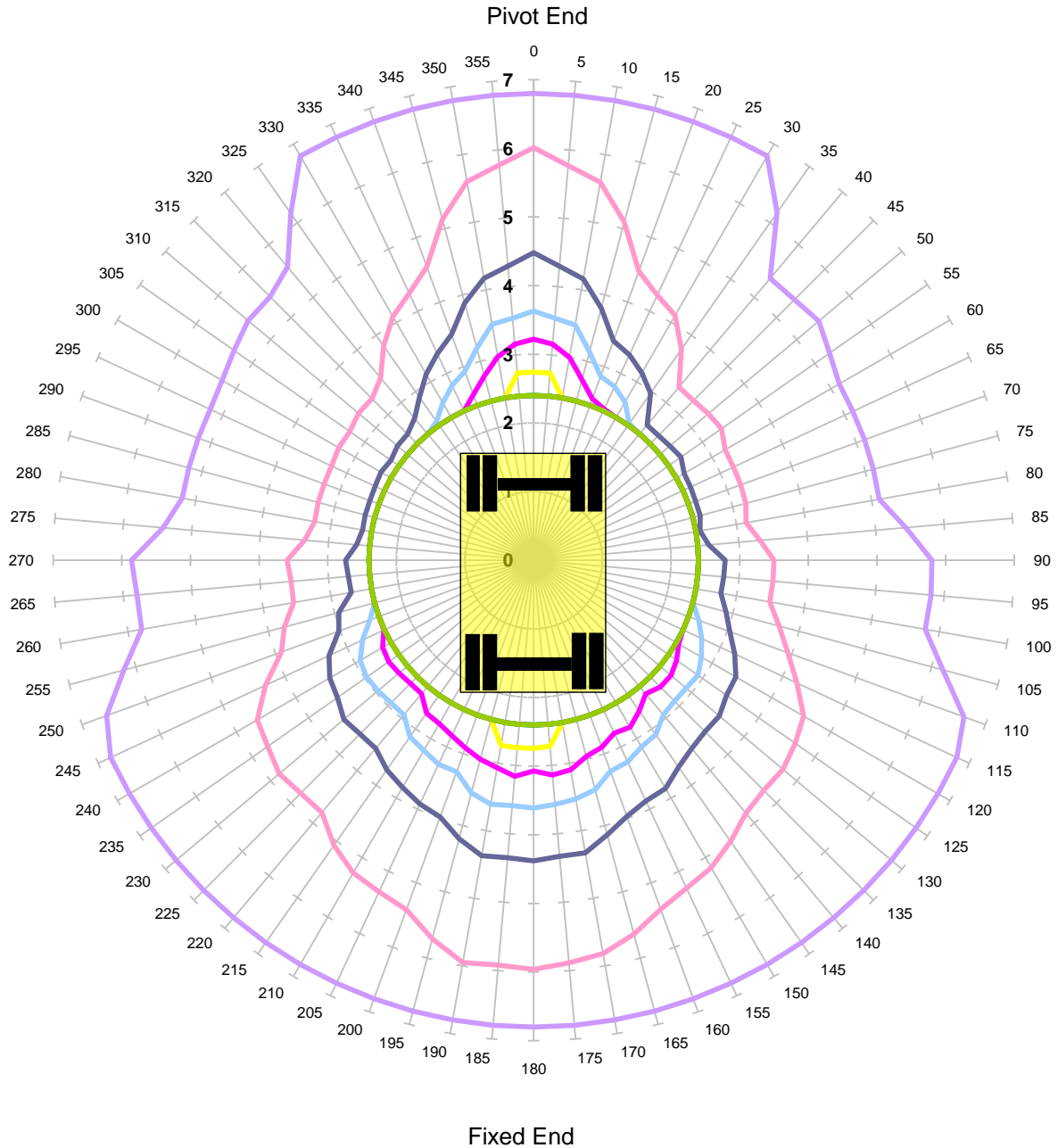

Units in Tonnes

- 1
- 2
- 3
- 4
- 5
- 6
- 7
- 8
- 9
- 10

<b>MACHINE &amp; MODEL:</b>	Volvo EW180	<b>REFERENCE:</b>	
<b>SERIAL No:</b>	8741011	<b>DATE OF CHART:</b>	4-Jun-2021
<b>EQUIPMENT:</b>	2.06m + 3.03m + 2.00m	<b>SAFETY FACTOR:</b>	47.0%
<b>COMMENT:</b>			

**Volvo EW180**  
**Max Capacity Contours of Radius(m) Plots 2.0m Dipper**  
**Level Ground Height 2m Lift BP**  
**Locked Road - Tandem Lift**

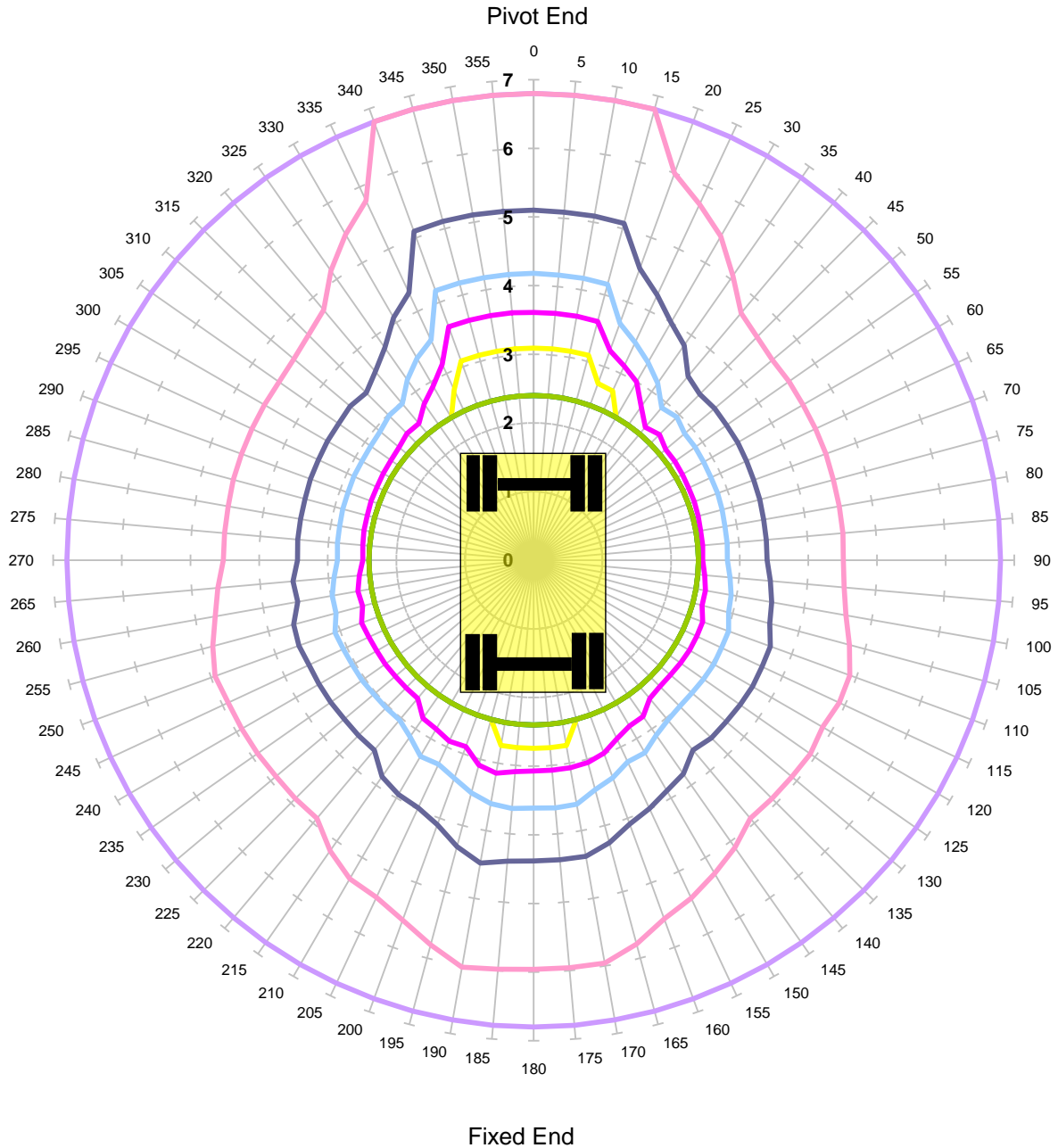

Units in Tonnes

- 1
- 2
- 3
- 4
- 5
- 6
- 7
- 8
- 9
- 10

<b>MACHINE &amp; MODEL:</b>	Volvo EW180	<b>REFERENCE:</b>	
<b>SERIAL No:</b>	8741011	<b>DATE OF CHART:</b>	4-Jun-2021
<b>EQUIPMENT:</b>	2.06m + 3.03m + 2.00m	<b>SAFETY FACTOR:</b>	47.0%
<b>COMMENT:</b>			

**Volvo EW180**  
**Max Capacity Contours of Radius(m) Plots 2.0m Dipper**  
**Gradient 1 in -25 Height 2m Lift QH**  
**Unlocked Rail Cant -150mm**

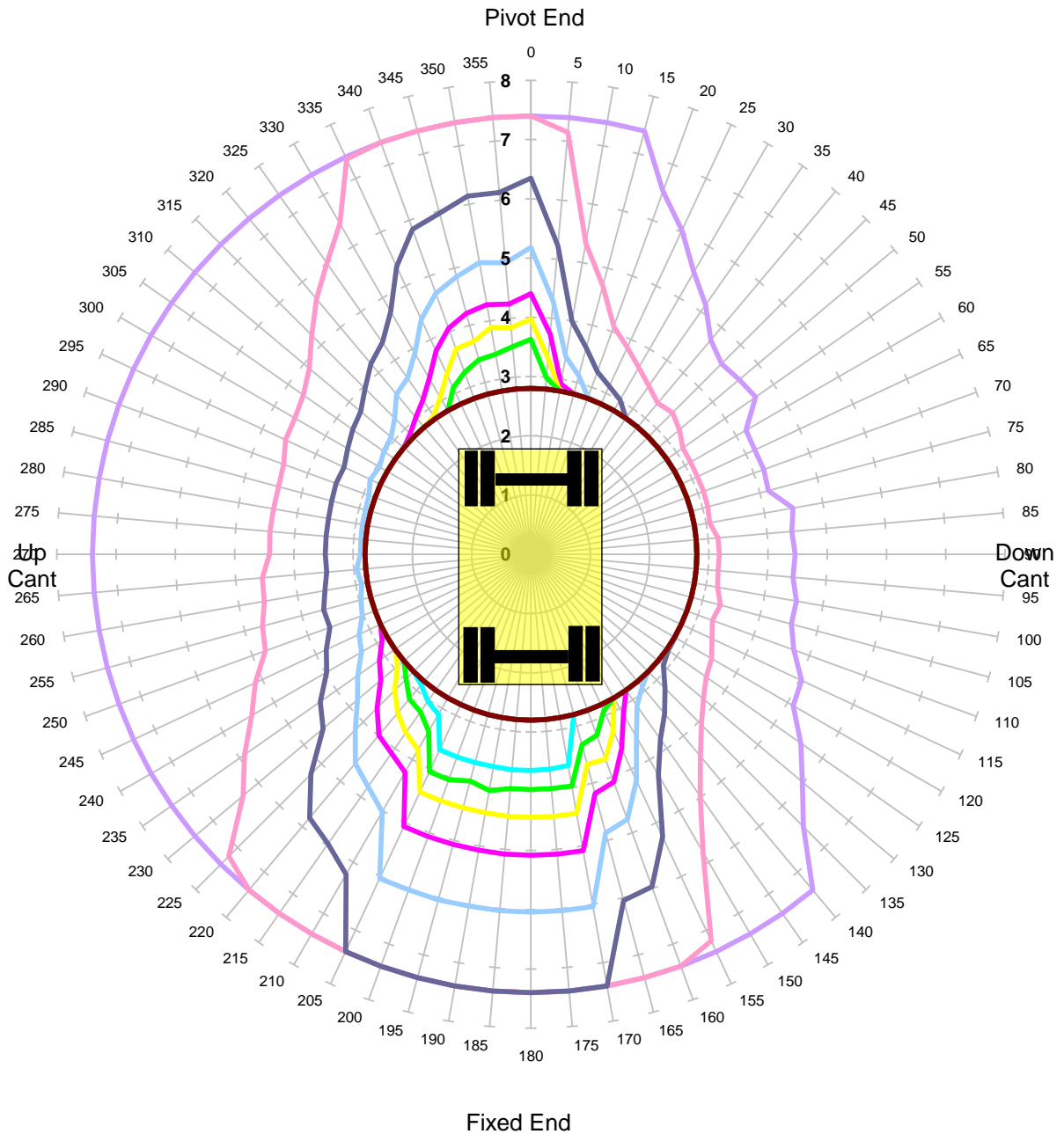

Units in Tonnes

- 1
- 2
- 3
- 4
- 5
- 6
- 7
- 8
- 9
- 10
- 11
- 12
- 13

<b>MACHINE &amp; MODEL:</b>	Volvo EW180	<b>REFERENCE:</b>	
<b>SERIAL No:</b>	8741011	<b>DATE OF CHART:</b>	4-Jun-2021
<b>EQUIPMENT:</b>	2.06m + 3.03m + 2.00m	<b>SAFETY FACTOR:</b>	67.0%
<b>COMMENT:</b>			

**Volvo EW180**  
**Max Capacity Contours of Radius(m) Plots 2.0m Dipper**  
**Gradient 1 in -25 Height 2m Lift QH**  
**Unlocked Rail Cant -50mm**

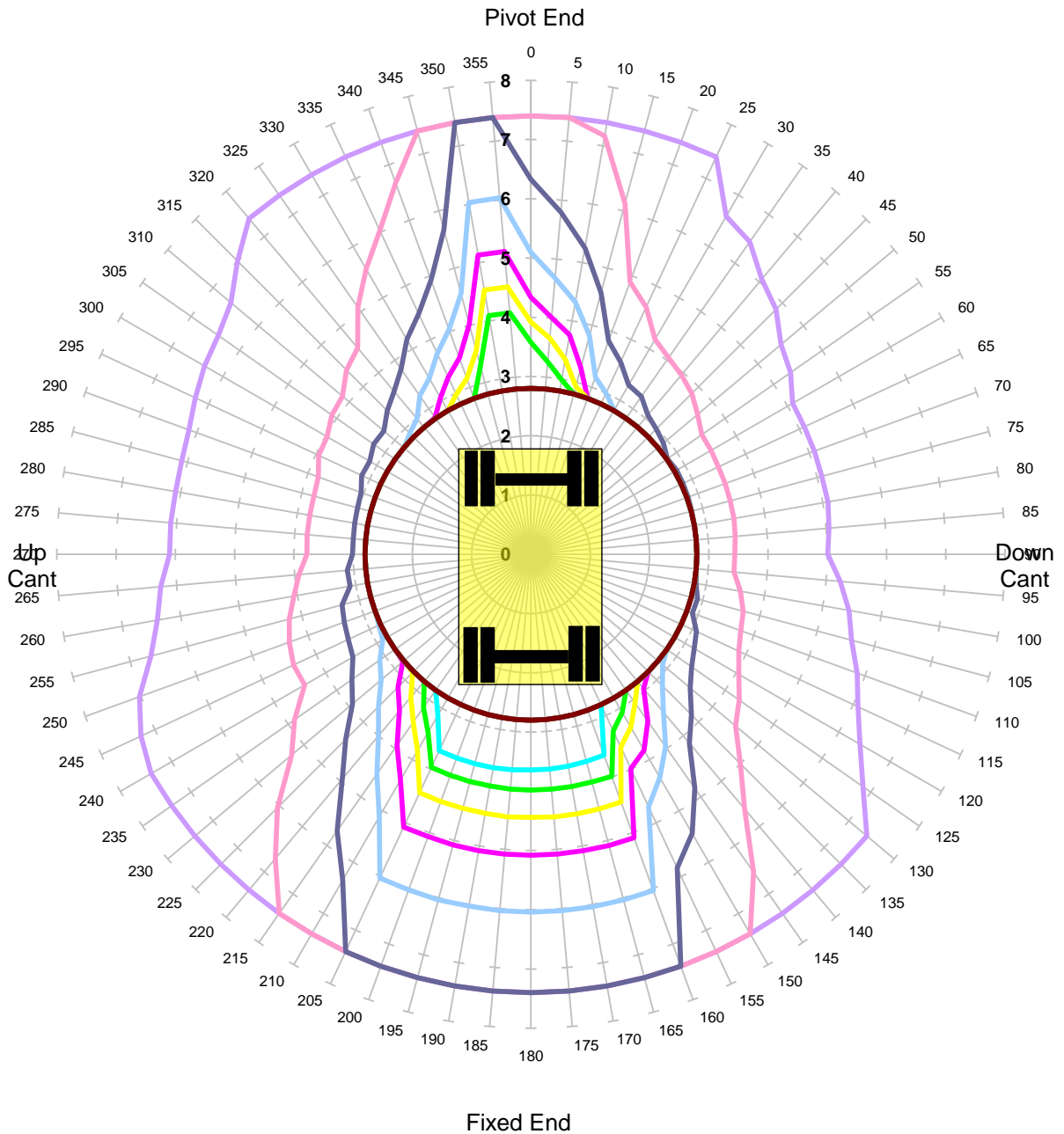

Units in Tonnes

- 1
- 2
- 3
- 4
- 5
- 6
- 7
- 8
- 9
- 10
- 11
- 12
- 13

<b>MACHINE &amp; MODEL:</b>	Volvo EW180	<b>REFERENCE:</b>	
<b>SERIAL No:</b>	8741011	<b>DATE OF CHART:</b>	4-Jun-2021
<b>EQUIPMENT:</b>	2.06m + 3.03m + 2.00m	<b>SAFETY FACTOR:</b>	67.0%
<b>COMMENT:</b>			

**Volvo EW180**  
**Max Capacity Contours of Radius(m) Plots 2.0m Dipper**  
**Gradient 1 in -25 Height 2m Lift QH**  
**Unlocked Rail Cant 50mm**

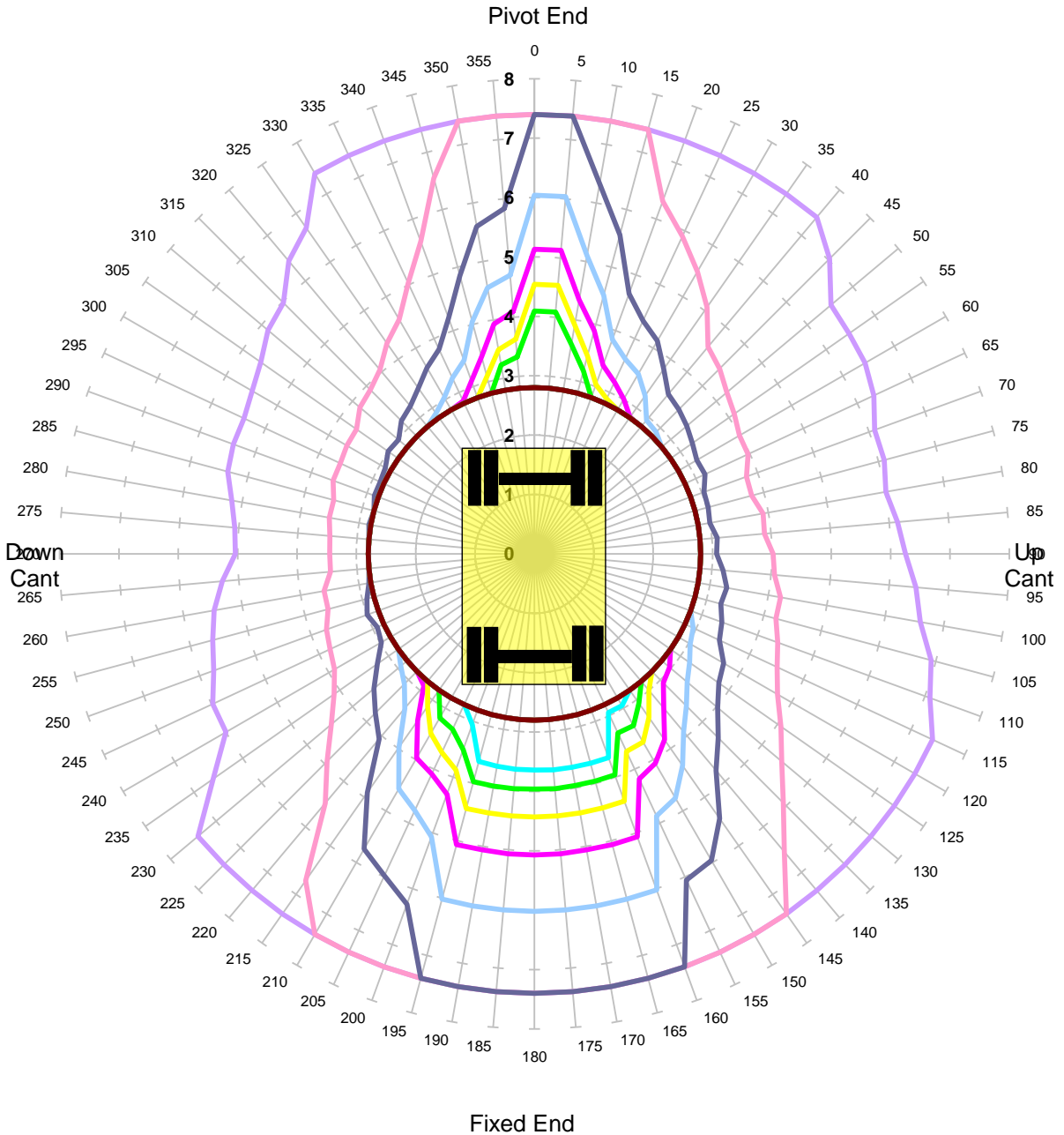

Units in Tonnes

- 1
- 2
- 3
- 4
- 5
- 6
- 7
- 8
- 9
- 10
- 11
- 12
- 13

<b>MACHINE &amp; MODEL:</b>	Volvo EW180	<b>REFERENCE:</b>	
<b>SERIAL No:</b>	8741011	<b>DATE OF CHART:</b>	4-Jun-2021
<b>EQUIPMENT:</b>	2.06m + 3.03m + 2.00m	<b>SAFETY FACTOR:</b>	67.0%
<b>COMMENT:</b>			

**Volvo EW180**  
**Max Capacity Contours of Radius(m) Plots 2.0m Dipper**  
**Gradient 1 in -25 Height 2m Lift QH**  
**Unlocked Rail Cant 150mm**

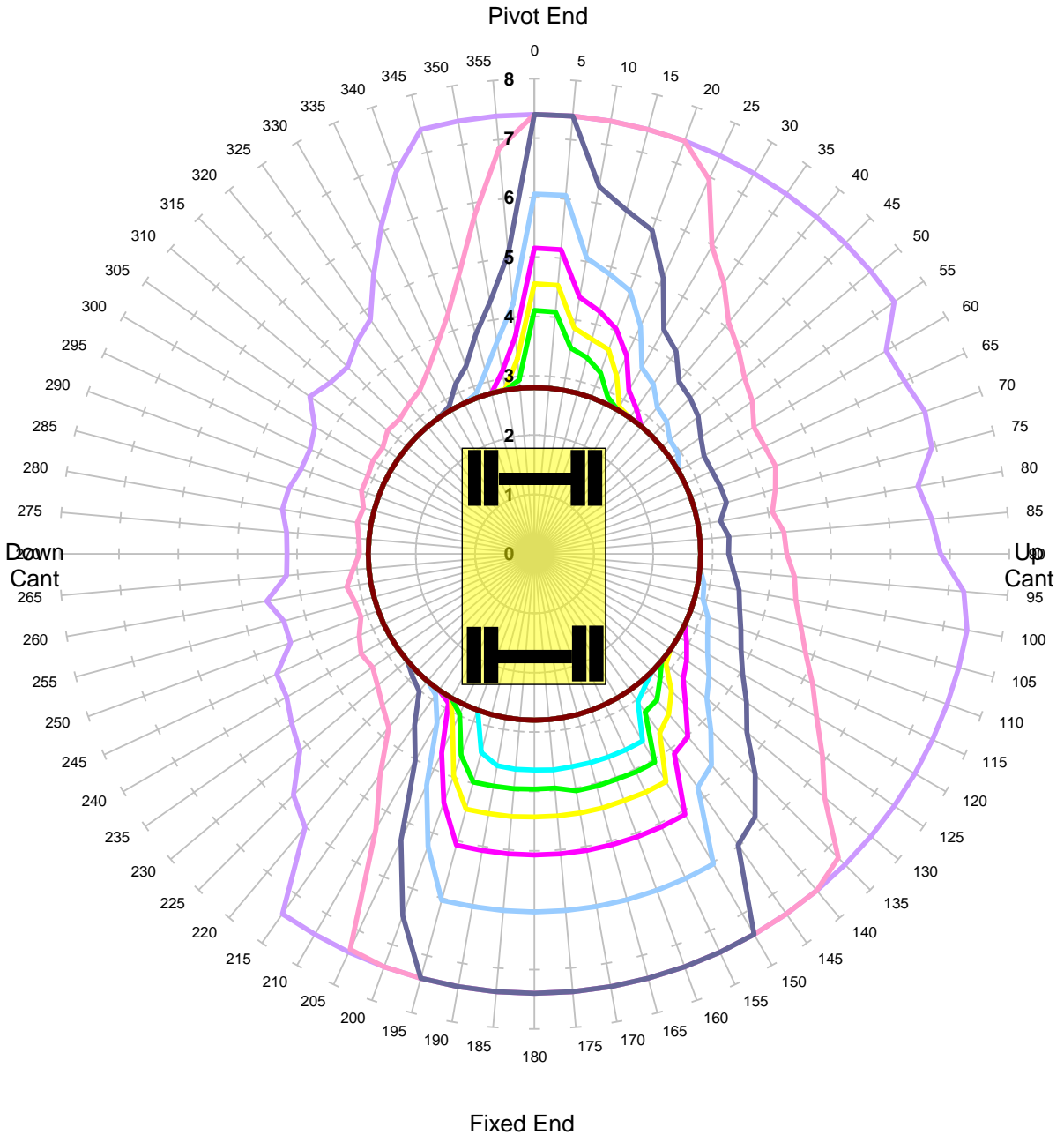

Units in Tonnes

- 1
- 2
- 3
- 4
- 5
- 6
- 7
- 8
- 9
- 10
- 11
- 12
- 13

<b>MACHINE &amp; MODEL:</b>	Volvo EW180	<b>REFERENCE:</b>	
<b>SERIAL No:</b>	8741011	<b>DATE OF CHART:</b>	4-Jun-2021
<b>EQUIPMENT:</b>	2.06m + 3.03m + 2.00m	<b>SAFETY FACTOR:</b>	67.0%
<b>COMMENT:</b>			



**Volvo EW180**  
**Max Capacity Contours of Radius(m) Plots 2.0m Dipper**  
**Gradient 1 in -25 Height 2m Lift QH**  
**Locked Rail Cant -150mm**

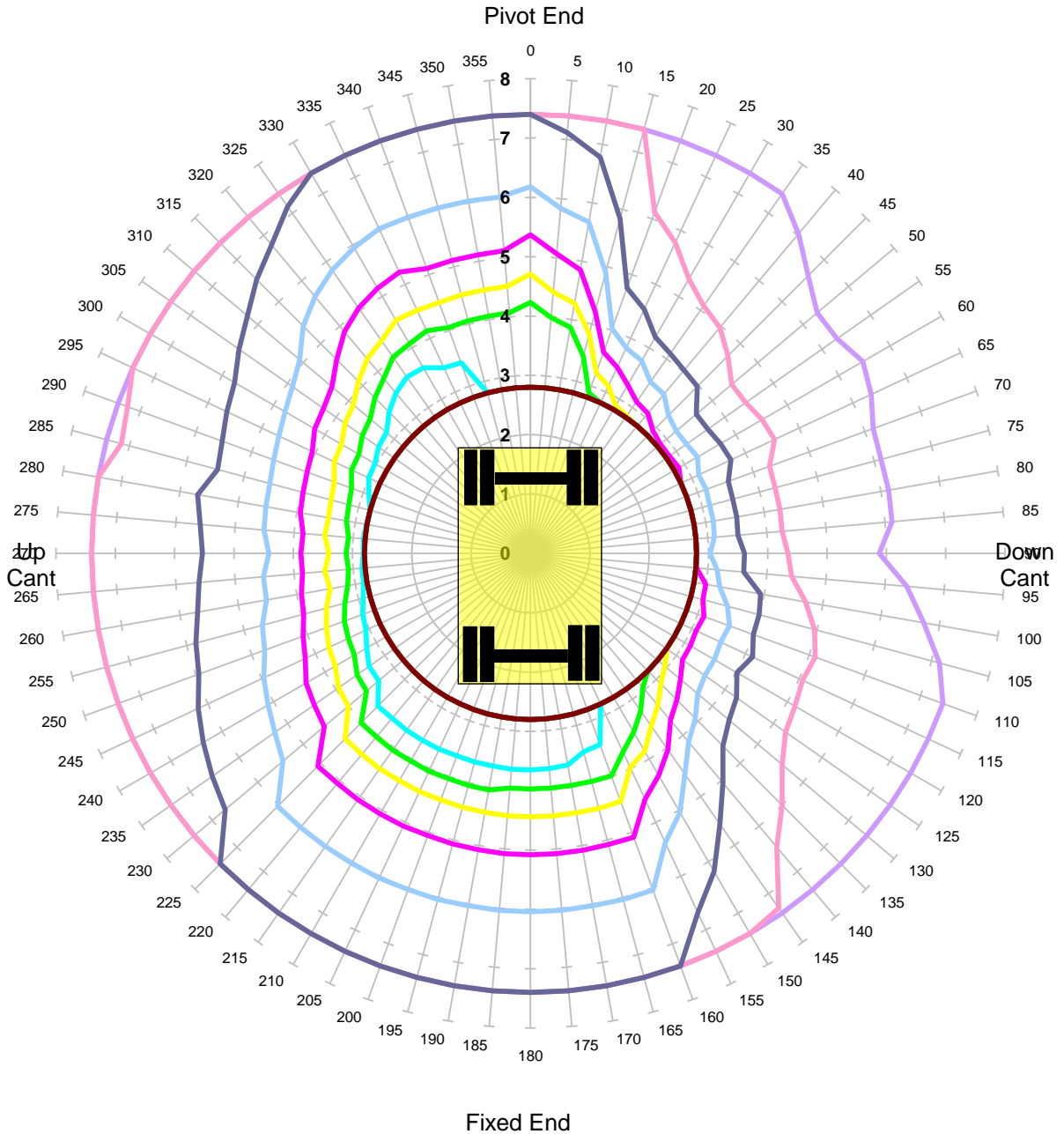

Units in Tonnes

- 1  
 — 2  
 — 3  
 — 4  
 — 5  
 — 6  
 — 7  
 — 8  
 — 9  
 — 10  
 — 11  
 — 12  
 — 13

<b>MACHINE &amp; MODEL:</b>	Volvo EW180	<b>REFERENCE:</b>	
<b>SERIAL No:</b>	8741011	<b>DATE OF CHART:</b>	4-Jun-2021
<b>EQUIPMENT:</b>	2.06m + 3.03m + 2.00m	<b>SAFETY FACTOR:</b>	90.0%
<b>COMMENT:</b>			

**Volvo EW180**  
**Max Capacity Contours of Radius(m) Plots 2.0m Dipper**  
**Gradient 1 in -25 Height 2m Lift QH**  
**Locked Rail Cant -50mm**

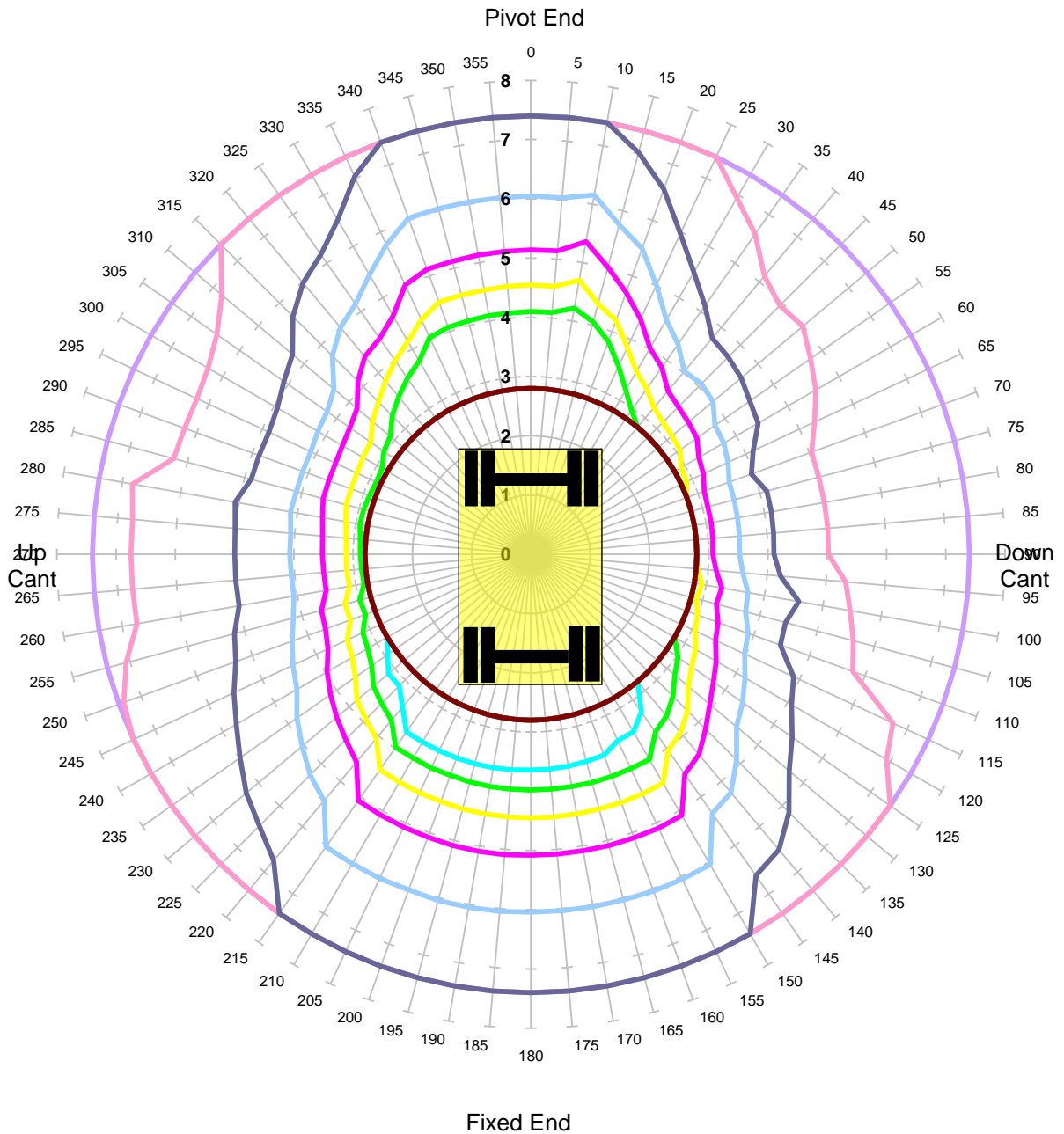

Units in Tonnes

- 1   
 — 2   
 — 3   
 — 4   
 — 5   
 — 6   
 — 7   
 — 8   
 — 9   
 — 10   
 — 11   
 — 12   
 — 13

<b>MACHINE &amp; MODEL:</b>	Volvo EW180	<b>REFERENCE:</b>	
<b>SERIAL No:</b>	8741011	<b>DATE OF CHART:</b>	4-Jun-2021
<b>EQUIPMENT:</b>	2.06m + 3.03m + 2.00m	<b>SAFETY FACTOR:</b>	90.0%
<b>COMMENT:</b>			

**Volvo EW180**  
**Max Capacity Contours of Radius(m) Plots 2.0m Dipper**  
**Gradient 1 in -25 Height 2m Lift QH**  
**Locked Rail Cant 50mm**

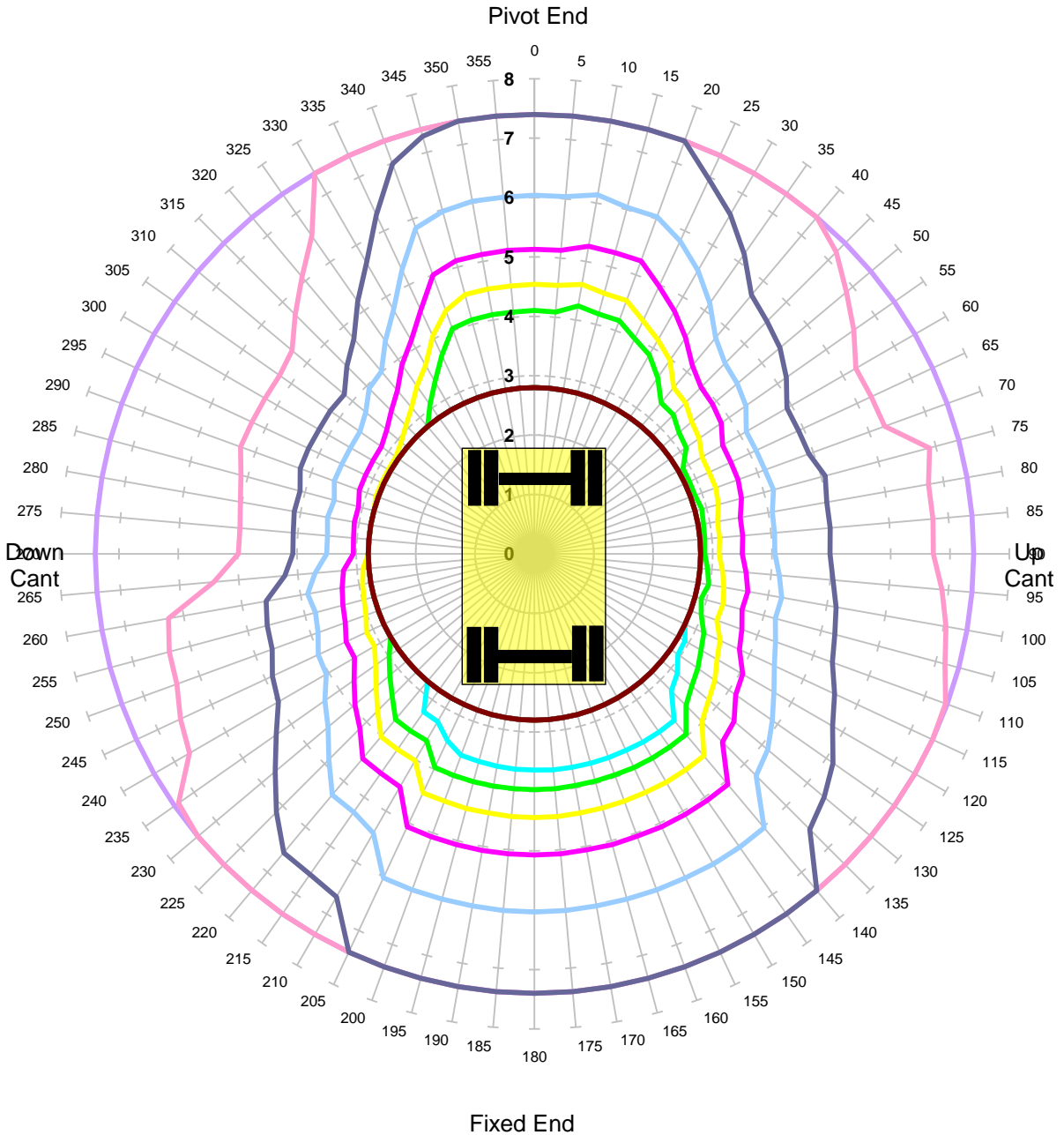

Units in Tonnes

- 1
- 2
- 3
- 4
- 5
- 6
- 7
- 8
- 9
- 10
- 11
- 12
- 13

<b>MACHINE &amp; MODEL:</b>	Volvo EW180	<b>REFERENCE:</b>	
<b>SERIAL No:</b>	8741011	<b>DATE OF CHART:</b>	4-Jun-2021
<b>EQUIPMENT:</b>	2.06m + 3.03m + 2.00m	<b>SAFETY FACTOR:</b>	90.0%
<b>COMMENT:</b>			

**Volvo EW180**  
**Max Capacity Contours of Radius(m) Plots 2.0m Dipper**  
**Gradient 1 in -25 Height 2m Lift QH**  
**Locked Rail Cant 150mm**

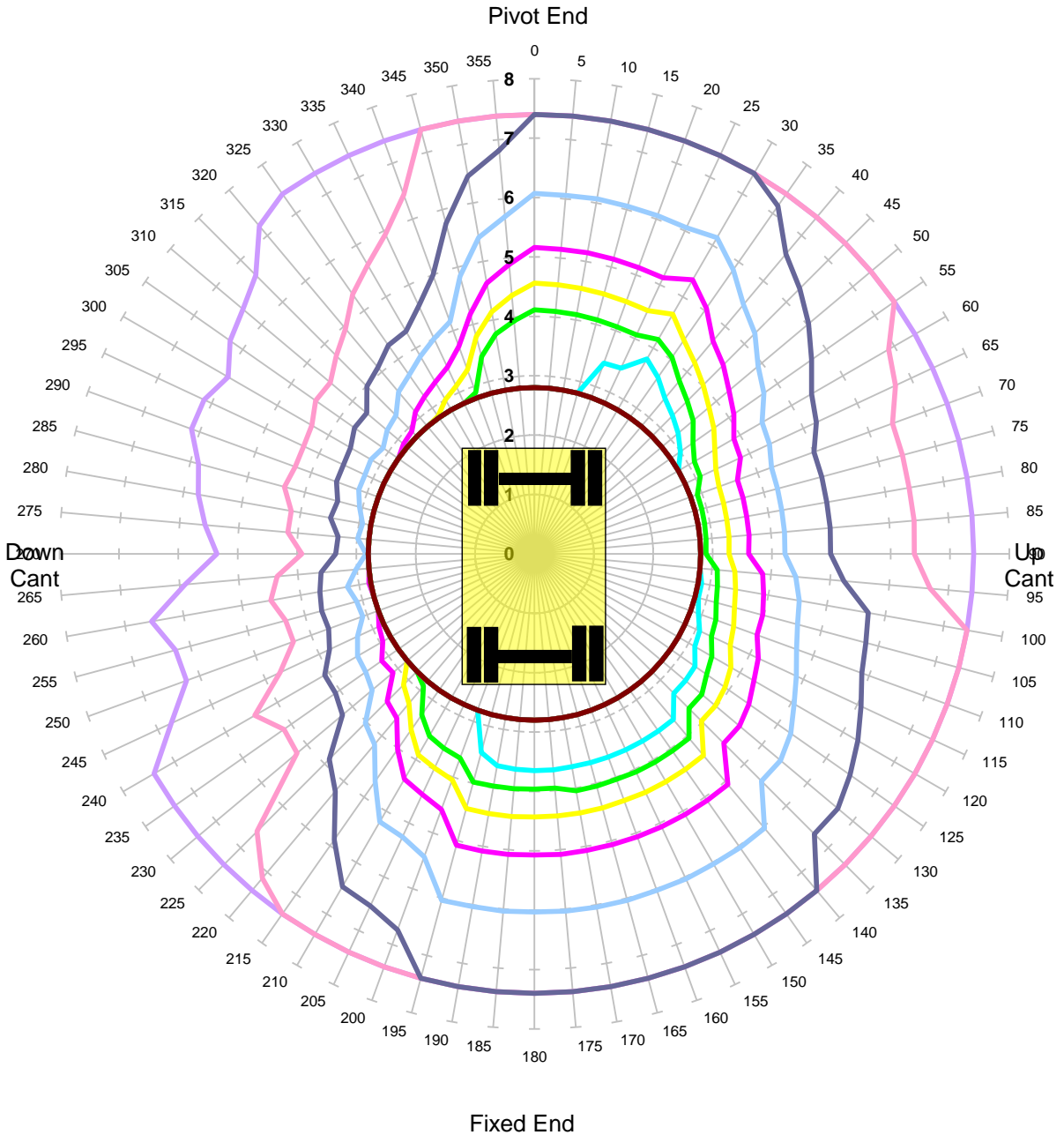

Units in Tonnes

- 1
- 2
- 3
- 4
- 5
- 6
- 7
- 8
- 9
- 10
- 11
- 12
- 13

<b>MACHINE &amp; MODEL:</b>	Volvo EW180	<b>REFERENCE:</b>	
<b>SERIAL No:</b>	8741011	<b>DATE OF CHART:</b>	4-Jun-2021
<b>EQUIPMENT:</b>	2.06m + 3.03m + 2.00m	<b>SAFETY FACTOR:</b>	90.0%
<b>COMMENT:</b>			

**Volvo EW180**  
**Max Capacity Contours of Radius(m) Plots 2.0m Dipper**  
**Level Ground Height 2m Lift QH**  
Unlocked Road

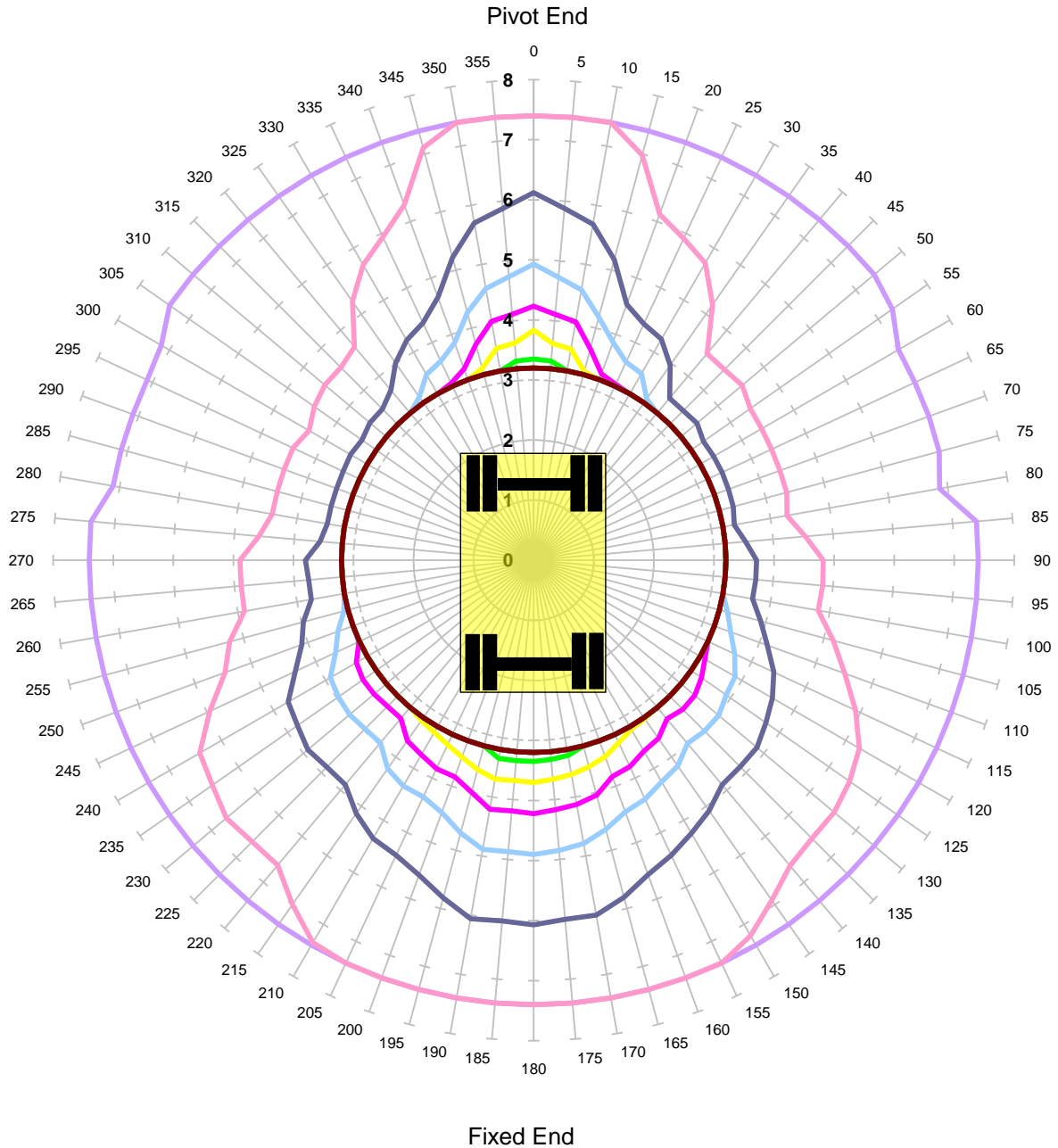

Units in Tonnes

- 1  
 — 2  
 — 3  
 — 4  
 — 5  
 — 6  
 — 7  
 — 8  
 — 9  
 — 10  
 — 11  
 — 12  
 — 13

<b>MACHINE &amp; MODEL:</b>	Volvo EW180	<b>REFERENCE:</b>	
<b>SERIAL No:</b>	8741011	<b>DATE OF CHART:</b>	4-Jun-2021
<b>EQUIPMENT:</b>	2.06m + 3.03m + 2.00m	<b>SAFETY FACTOR:</b>	71.0%
<b>COMMENT:</b>			

**Volvo EW180**  
**Max Capacity Contours of Radius(m) Plots 2.0m Dipper**  
**Level Ground Height 2m Lift QH**  
**Locked Road**

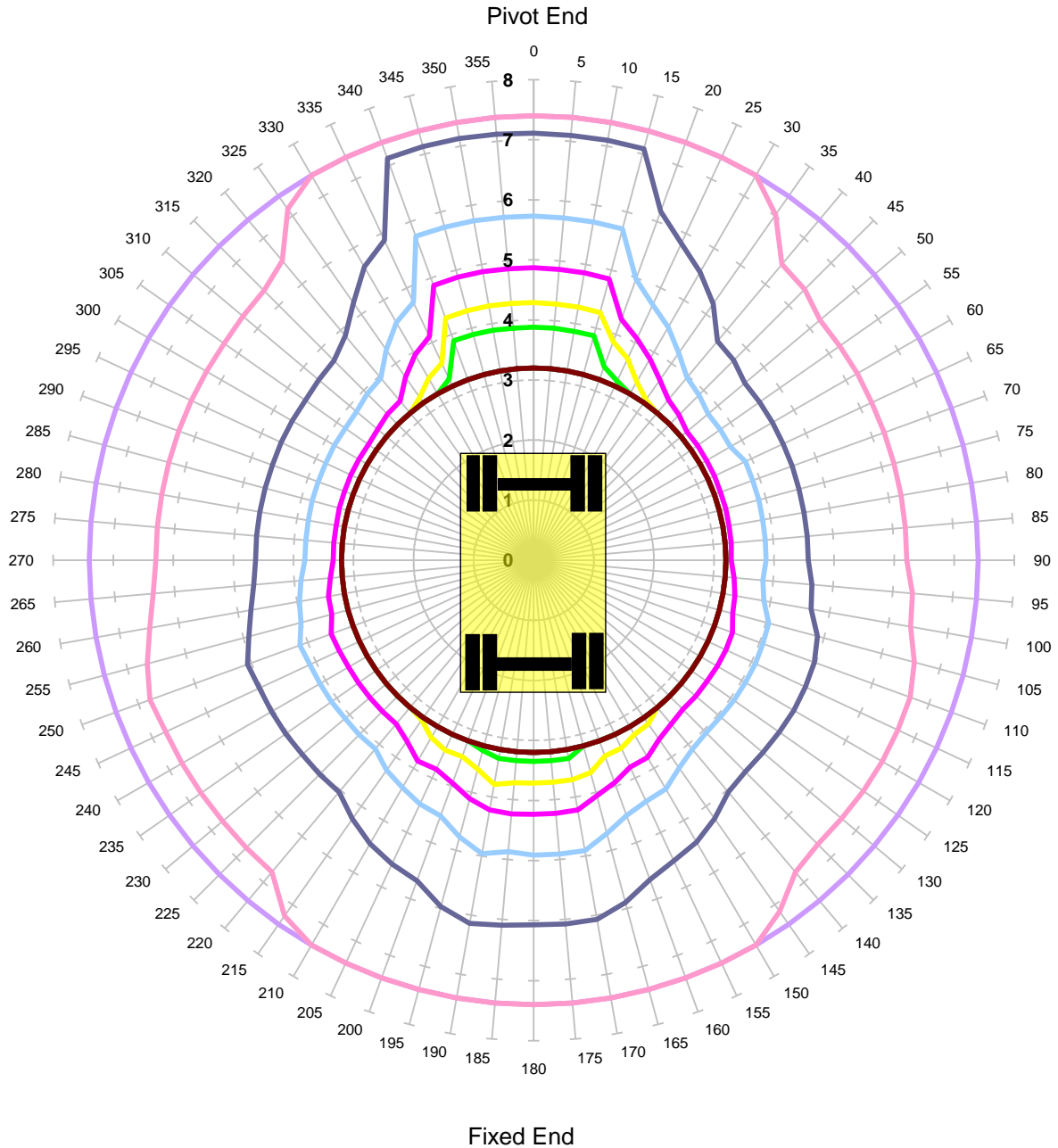

Units in Tonnes

- 1  
 — 2  
 — 3  
 — 4  
 — 5  
 — 6  
 — 7  
 — 8  
 — 9  
 — 10  
 — 11  
 — 12  
 — 13

<b>MACHINE &amp; MODEL:</b>	Volvo EW180	<b>REFERENCE:</b>	
<b>SERIAL No:</b>	8741011	<b>DATE OF CHART:</b>	4-Jun-2021
<b>EQUIPMENT:</b>	2.06m + 3.03m + 2.00m	<b>SAFETY FACTOR:</b>	71.0%
<b>COMMENT:</b>			

**Volvo EW180**  
**Max Capacity Contours of Radius(m) Plots 2.0m Dipper**  
**Gradient 1 in -25 Height 2m Lift QH**  
**Unlocked Rail Cant -150mm - Tandem Lift**

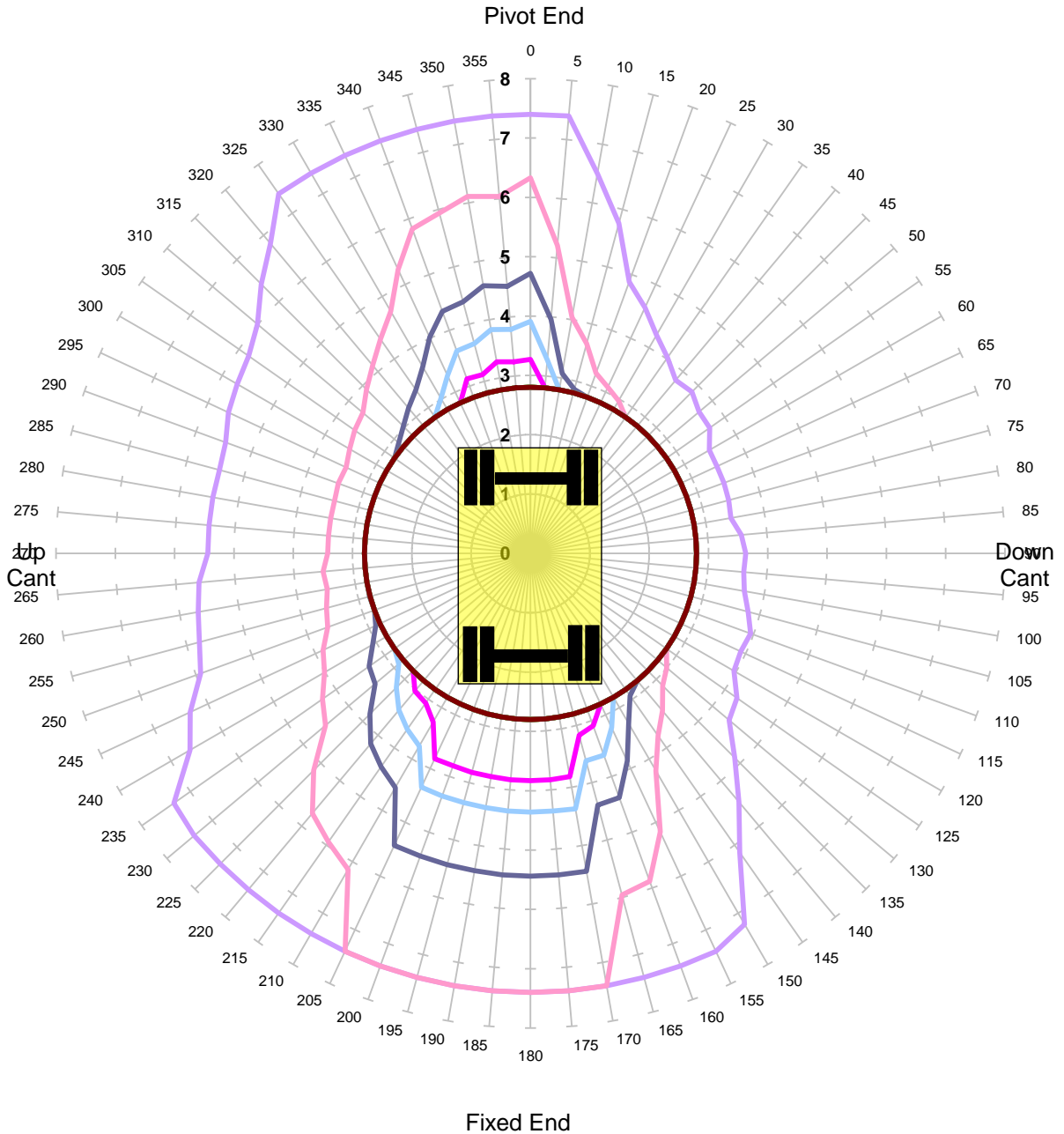

Units in Tonnes

- 1
- 2
- 3
- 4
- 5
- 6
- 7
- 8
- 9
- 10
- 11
- 12
- 13

<b>MACHINE &amp; MODEL:</b>	Volvo EW180	<b>REFERENCE:</b>	
<b>SERIAL No:</b>	8741011	<b>DATE OF CHART:</b>	4-Jun-2021
<b>EQUIPMENT:</b>	2.06m + 3.03m + 2.00m	<b>SAFETY FACTOR:</b>	44.0%
<b>COMMENT:</b>			

**Volvo EW180**  
**Max Capacity Contours of Radius(m) Plots 2.0m Dipper**  
**Gradient 1 in -25 Height 2m Lift QH**  
**Unlocked Rail Cant -50mm - Tandem Lift**

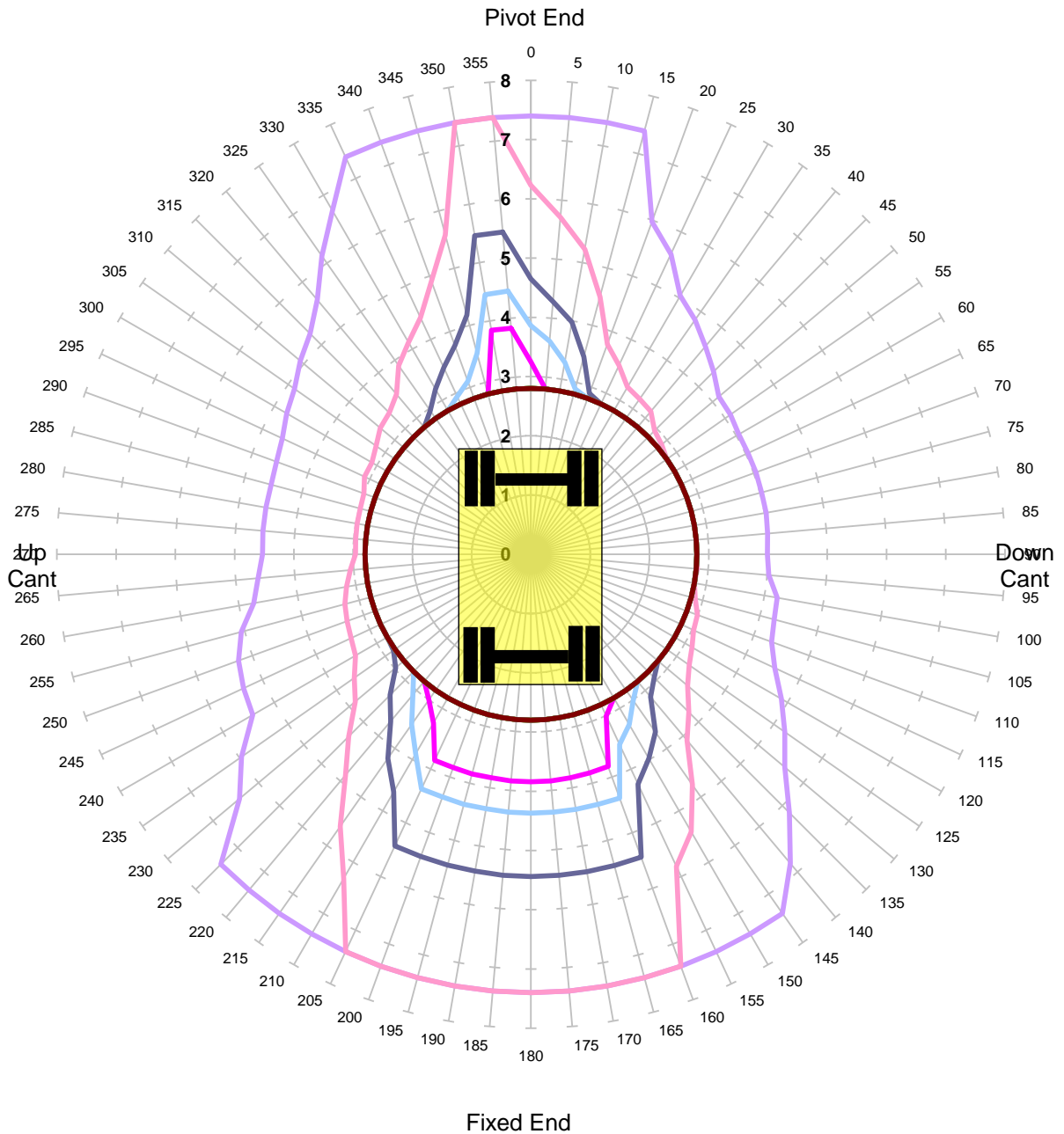

Units in Tonnes

- 1
- 2
- 3
- 4
- 5
- 6
- 7
- 8
- 9
- 10
- 11
- 12
- 13

<b>MACHINE &amp; MODEL:</b>	Volvo EW180	<b>REFERENCE:</b>	
<b>SERIAL No:</b>	8741011	<b>DATE OF CHART:</b>	4-Jun-2021
<b>EQUIPMENT:</b>	2.06m + 3.03m + 2.00m	<b>SAFETY FACTOR:</b>	44.0%
<b>COMMENT:</b>			



**Volvo EW180**  
**Max Capacity Contours of Radius(m) Plots 2.0m Dipper**  
**Gradient 1 in -25 Height 2m Lift QH**  
**Unlocked Rail Cant 50mm - Tandem Lift**

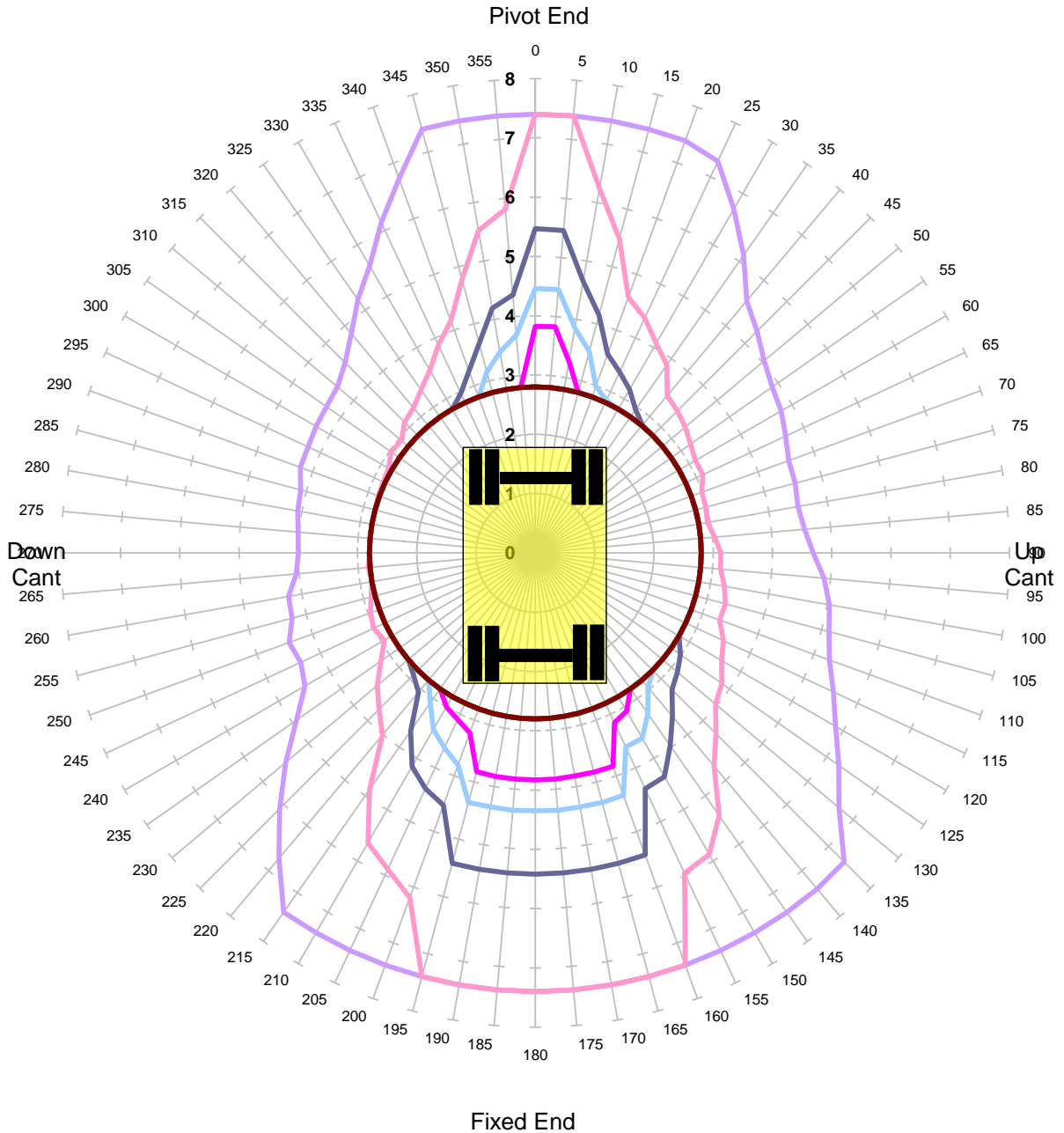

Units in Tonnes

- 1
- 2
- 3
- 4
- 5
- 6
- 7
- 8
- 9
- 10
- 11
- 12
- 13

<b>MACHINE &amp; MODEL:</b>	Volvo EW180	<b>REFERENCE:</b>	
<b>SERIAL No:</b>	8741011	<b>DATE OF CHART:</b>	4-Jun-2021
<b>EQUIPMENT:</b>	2.06m + 3.03m + 2.00m	<b>SAFETY FACTOR:</b>	44.0%
<b>COMMENT:</b>			

**Volvo EW180**  
**Max Capacity Contours of Radius(m) Plots 2.0m Dipper**  
**Gradient 1 in -25 Height 2m Lift QH**  
**Unlocked Rail Cant 150mm - Tandem Lift**

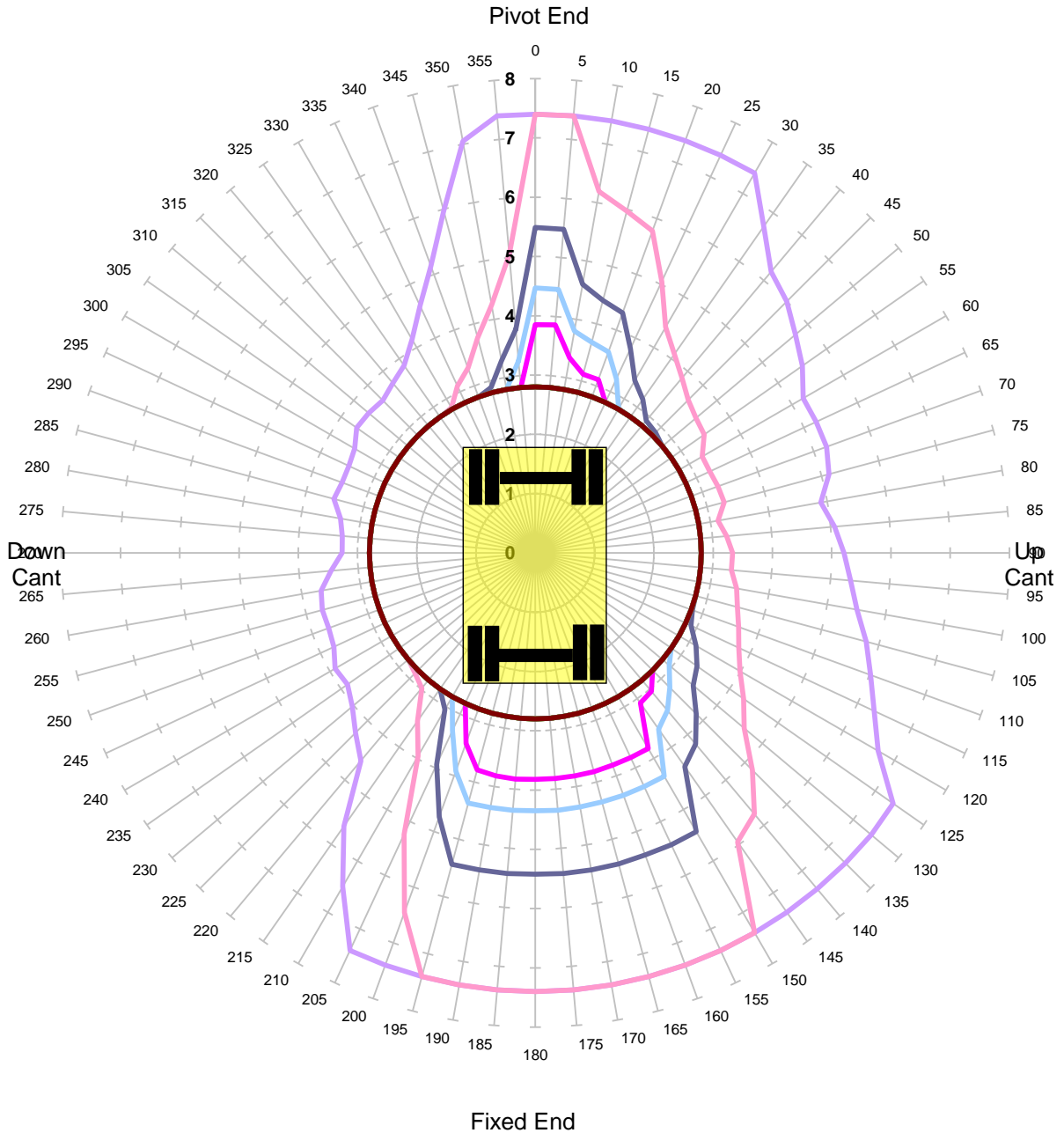

Units in Tonnes

- 1
- 2
- 3
- 4
- 5
- 6
- 7
- 8
- 9
- 10
- 11
- 12
- 13

<b>MACHINE &amp; MODEL:</b>	Volvo EW180	<b>REFERENCE:</b>	
<b>SERIAL No:</b>	8741011	<b>DATE OF CHART:</b>	4-Jun-2021
<b>EQUIPMENT:</b>	2.06m + 3.03m + 2.00m	<b>SAFETY FACTOR:</b>	44.0%
<b>COMMENT:</b>			

**Volvo EW180**  
**Max Capacity Contours of Radius(m) Plots 2.0m Dipper**  
**Gradient 1 in -25 Height 2m Lift QH**  
**Locked Rail Cant -150mm - Tandem Lift**

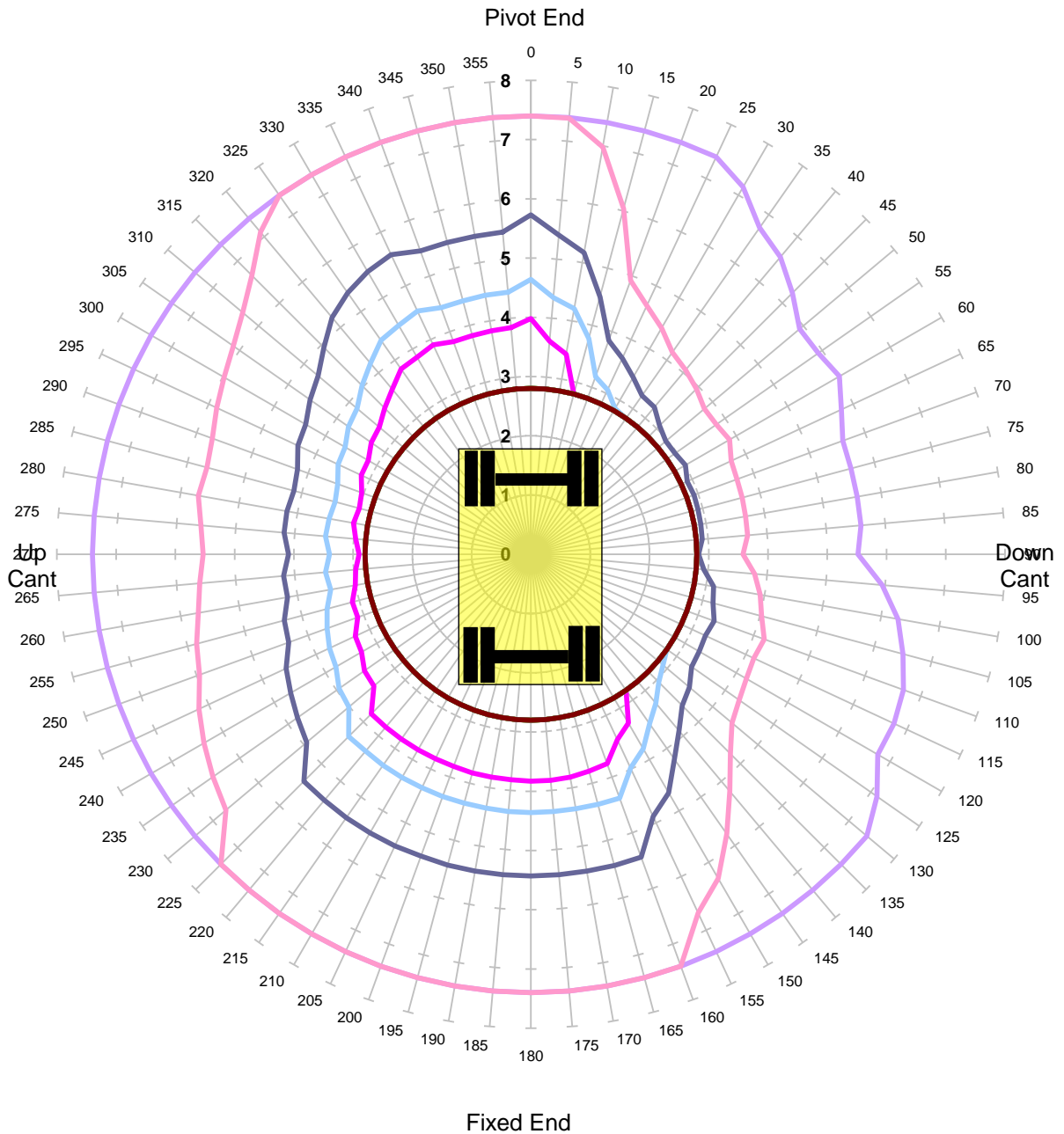

Units in Tonnes

- 1  
 — 2  
 — 3  
 — 4  
 — 5  
 — 6  
 — 7  
 — 8  
 — 9  
 — 10  
 — 11  
 — 12  
 — 13

<b>MACHINE &amp; MODEL:</b>	Volvo EW180	<b>REFERENCE:</b>	
<b>SERIAL No:</b>	8741011	<b>DATE OF CHART:</b>	4-Jun-2021
<b>EQUIPMENT:</b>	2.06m + 3.03m + 2.00m	<b>SAFETY FACTOR:</b>	59.0%
<b>COMMENT:</b>			

**Volvo EW180**  
**Max Capacity Contours of Radius(m) Plots 2.0m Dipper**  
**Gradient 1 in -25 Height 2m Lift QH**  
**Locked Rail Cant -50mm - Tandem Lift**

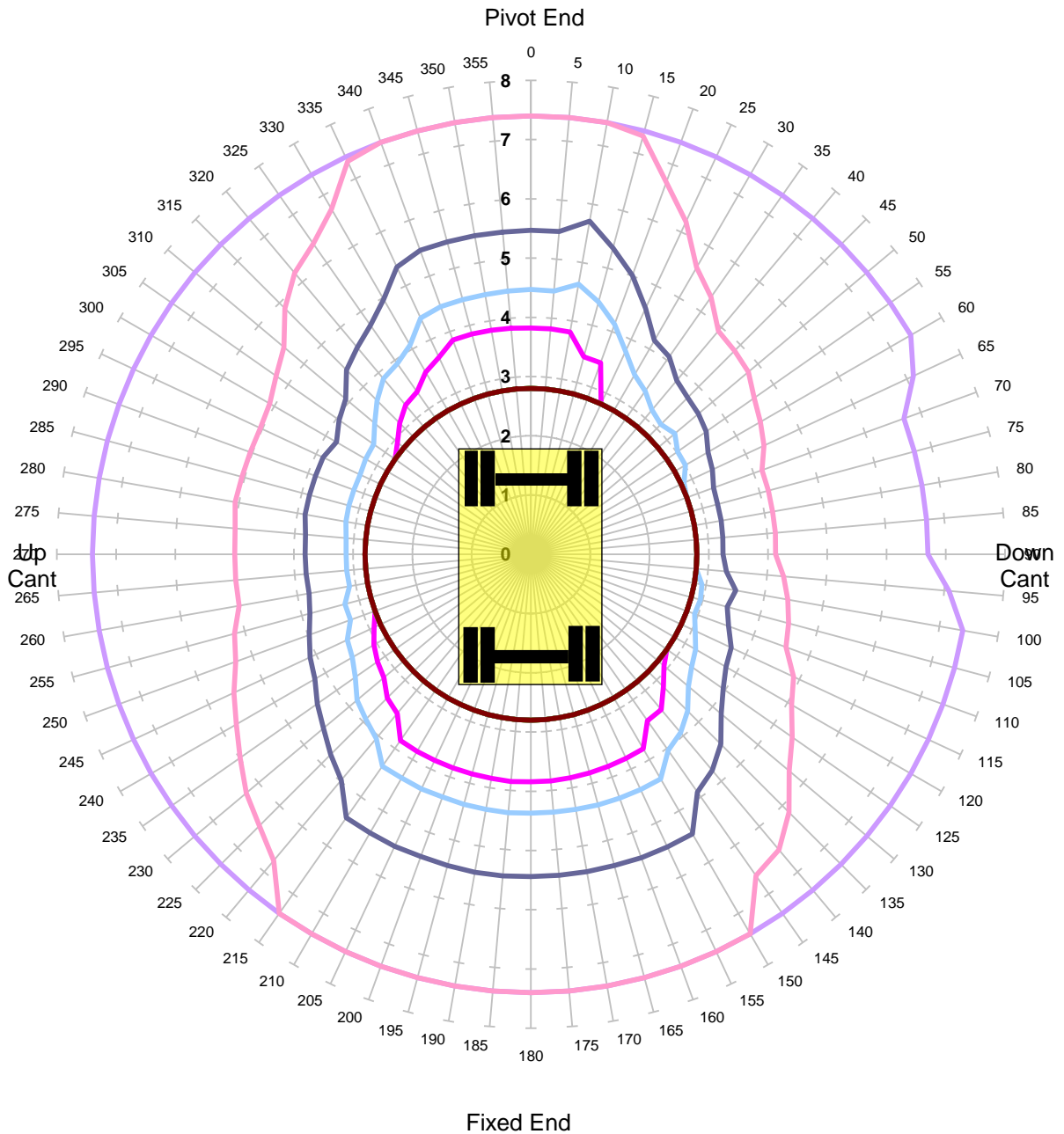

Units in Tonnes

- 1   
 — 2   
 — 3   
 — 4   
 — 5   
 — 6   
 — 7   
 — 8   
 — 9   
 — 10   
 — 11   
 — 12   
 — 13

<b>MACHINE &amp; MODEL:</b>	Volvo EW180	<b>REFERENCE:</b>	
<b>SERIAL No:</b>	8741011	<b>DATE OF CHART:</b>	4-Jun-2021
<b>EQUIPMENT:</b>	2.06m + 3.03m + 2.00m	<b>SAFETY FACTOR:</b>	59.0%
<b>COMMENT:</b>			

**Volvo EW180**  
**Max Capacity Contours of Radius(m) Plots 2.0m Dipper**  
**Gradient 1 in -25 Height 2m Lift QH**  
**Locked Rail Cant 50mm - Tandem Lift**

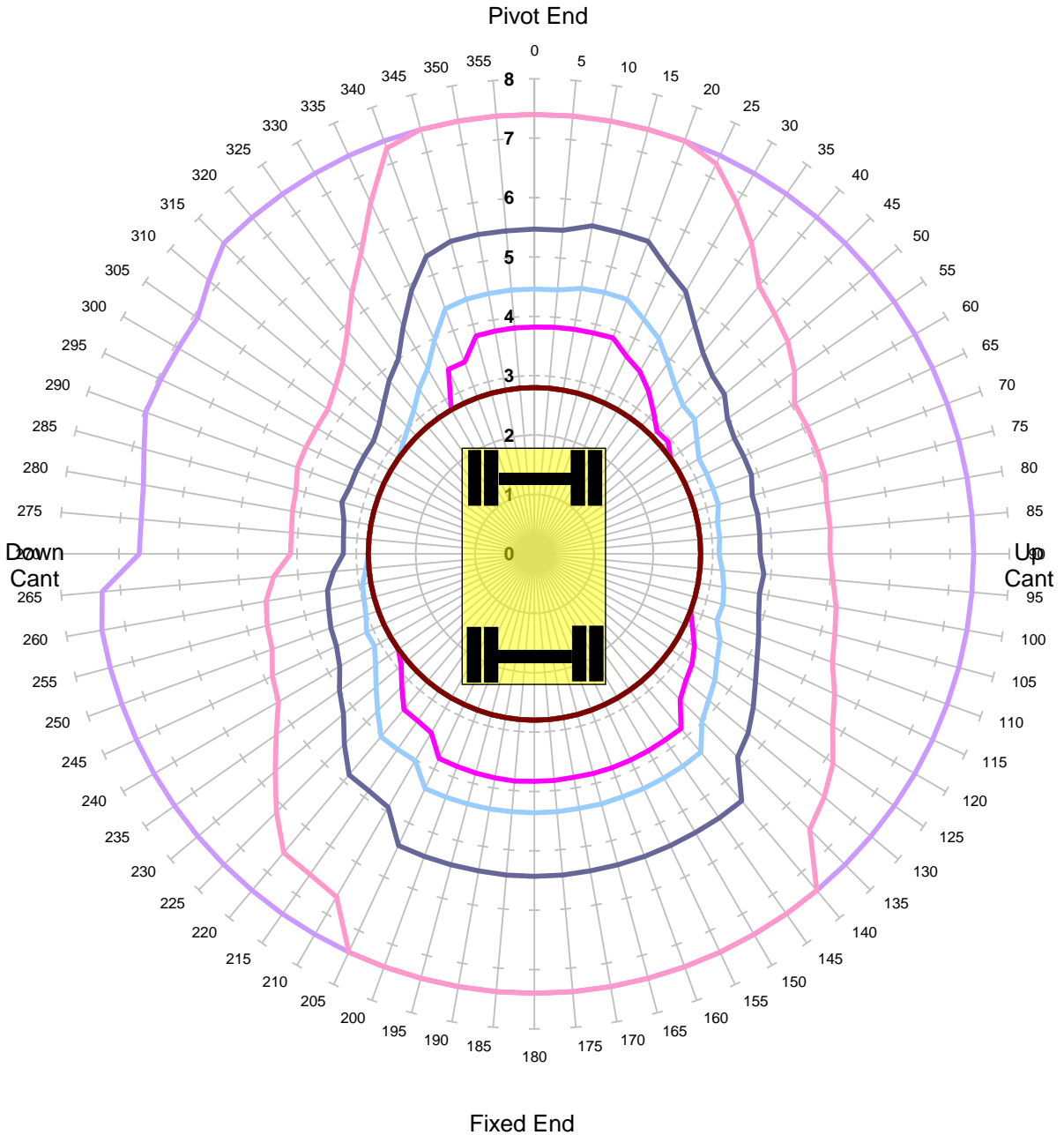

Units in Tonnes

- 1
- 2
- 3
- 4
- 5
- 6
- 7
- 8
- 9
- 10
- 11
- 12
- 13

<b>MACHINE &amp; MODEL:</b>	Volvo EW180	<b>REFERENCE:</b>	
<b>SERIAL No:</b>	8741011	<b>DATE OF CHART:</b>	4-Jun-2021
<b>EQUIPMENT:</b>	2.06m + 3.03m + 2.00m	<b>SAFETY FACTOR:</b>	59.0%
<b>COMMENT:</b>			

**Volvo EW180**  
**Max Capacity Contours of Radius(m) Plots 2.0m Dipper**  
**Gradient 1 in -25 Height 2m Lift QH**  
**Locked Rail Cant 150mm - Tandem Lift**

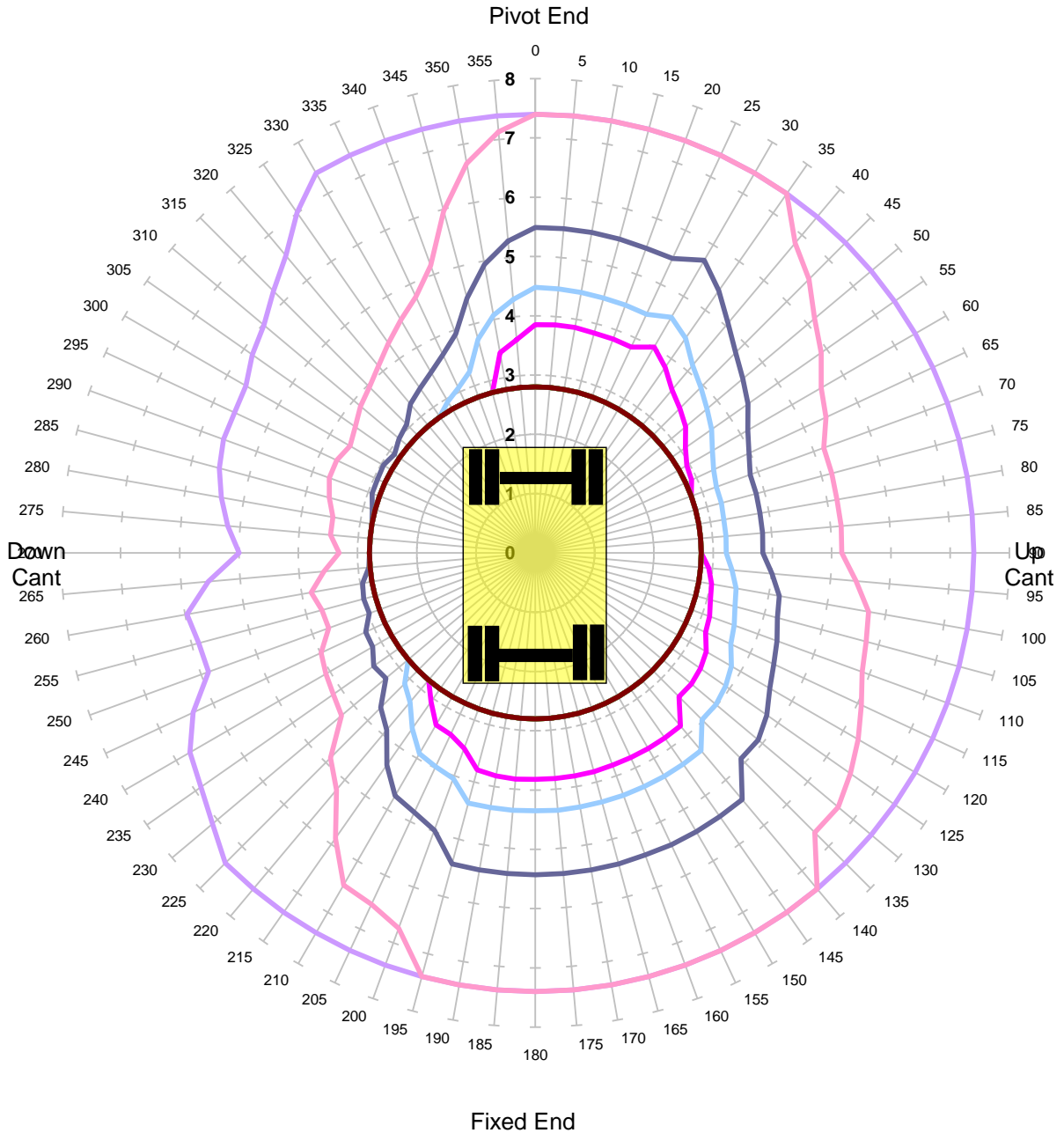

Units in Tonnes

- 1   
 — 2   
 — 3   
 — 4   
 — 5   
 — 6   
 — 7   
 — 8   
 — 9   
 — 10   
 — 11   
 — 12   
 — 13

<b>MACHINE &amp; MODEL:</b>	Volvo EW180	<b>REFERENCE:</b>	
<b>SERIAL No:</b>	8741011	<b>DATE OF CHART:</b>	4-Jun-2021
<b>EQUIPMENT:</b>	2.06m + 3.03m + 2.00m	<b>SAFETY FACTOR:</b>	59.0%
<b>COMMENT:</b>			

**Volvo EW180**  
**Max Capacity Contours of Radius(m) Plots 2.0m Dipper**  
**Level Ground Height 2m Lift QH**  
**Unlocked Road - Tandem Lift**

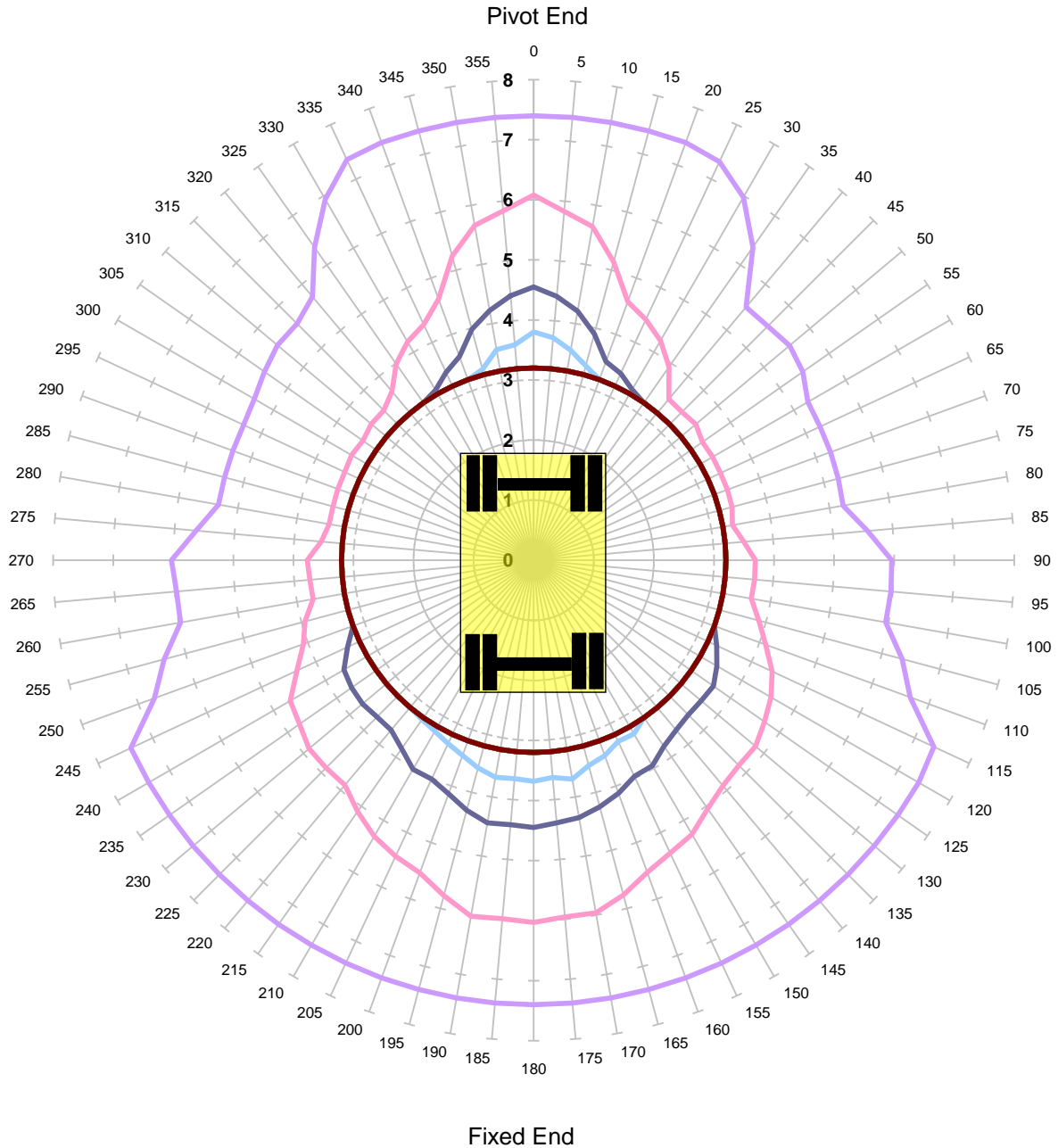

Units in Tonnes

- 1
- 2
- 3
- 4
- 5
- 6
- 7
- 8
- 9
- 10
- 11
- 12
- 13

<b>MACHINE &amp; MODEL:</b>	Volvo EW180	<b>REFERENCE:</b>	
<b>SERIAL No:</b>	8741011	<b>DATE OF CHART:</b>	4-Jun-2021
<b>EQUIPMENT:</b>	2.06m + 3.03m + 2.00m	<b>SAFETY FACTOR:</b>	47.0%
<b>COMMENT:</b>			

**Volvo EW180**  
**Max Capacity Contours of Radius(m) Plots 2.0m Dipper**  
**Level Ground Height 2m Lift QH**  
**Locked Road - Tandem Lift**

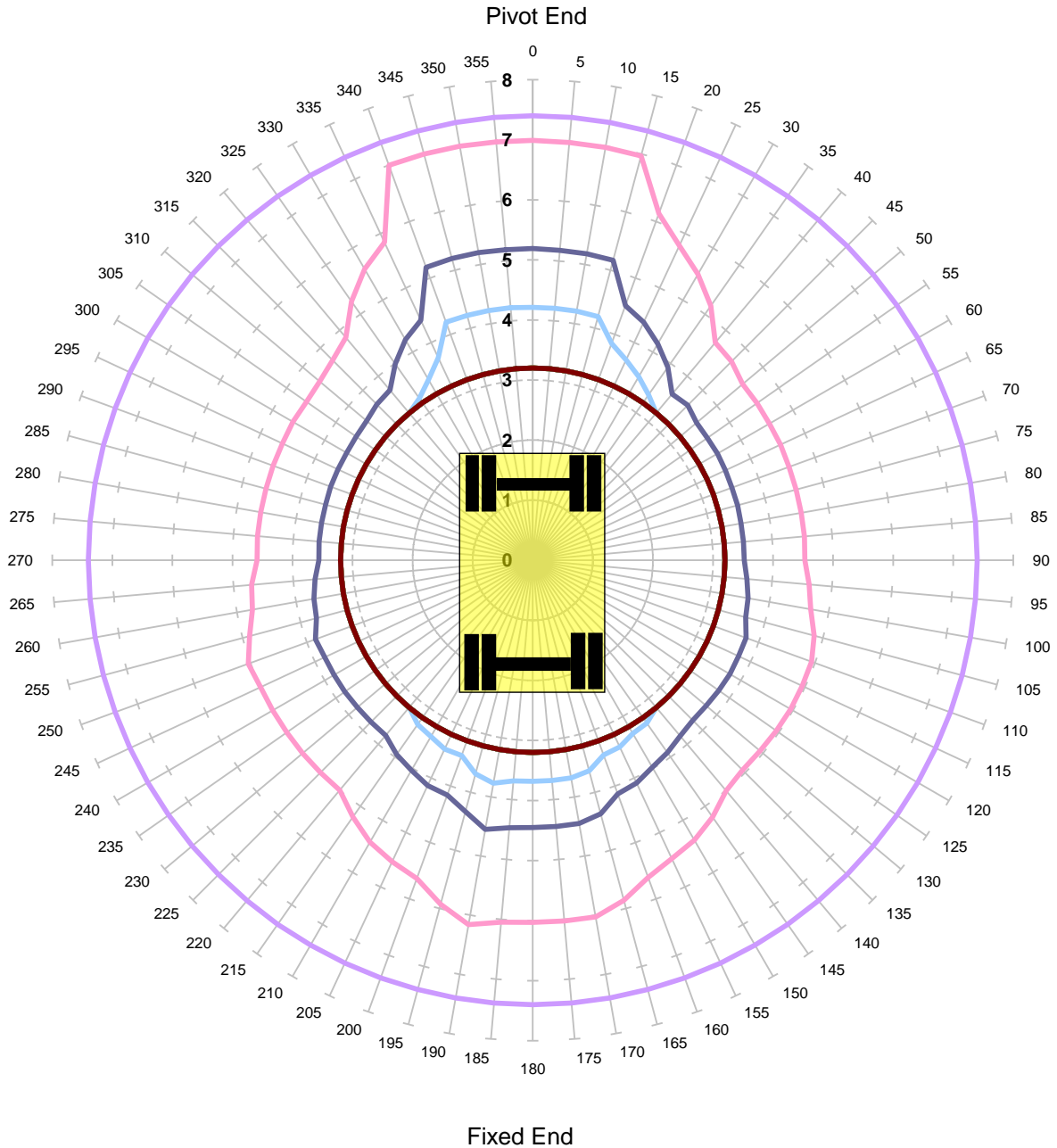

Units in Tonnes

- 1
- 2
- 3
- 4
- 5
- 6
- 7
- 8
- 9
- 10
- 11
- 12
- 13

<b>MACHINE &amp; MODEL:</b>	Volvo EW180	<b>REFERENCE:</b>	
<b>SERIAL No:</b>	8741011	<b>DATE OF CHART:</b>	4-Jun-2021
<b>EQUIPMENT:</b>	2.06m + 3.03m + 2.00m	<b>SAFETY FACTOR:</b>	47.0%
<b>COMMENT:</b>			