

Volvo EW180
Max Capacity Contours of Radius(m) Plots 2.0m Dipper
Gradient 1 in -25 Height 2m Lift BP
Unlocked Rail Cant -150mm

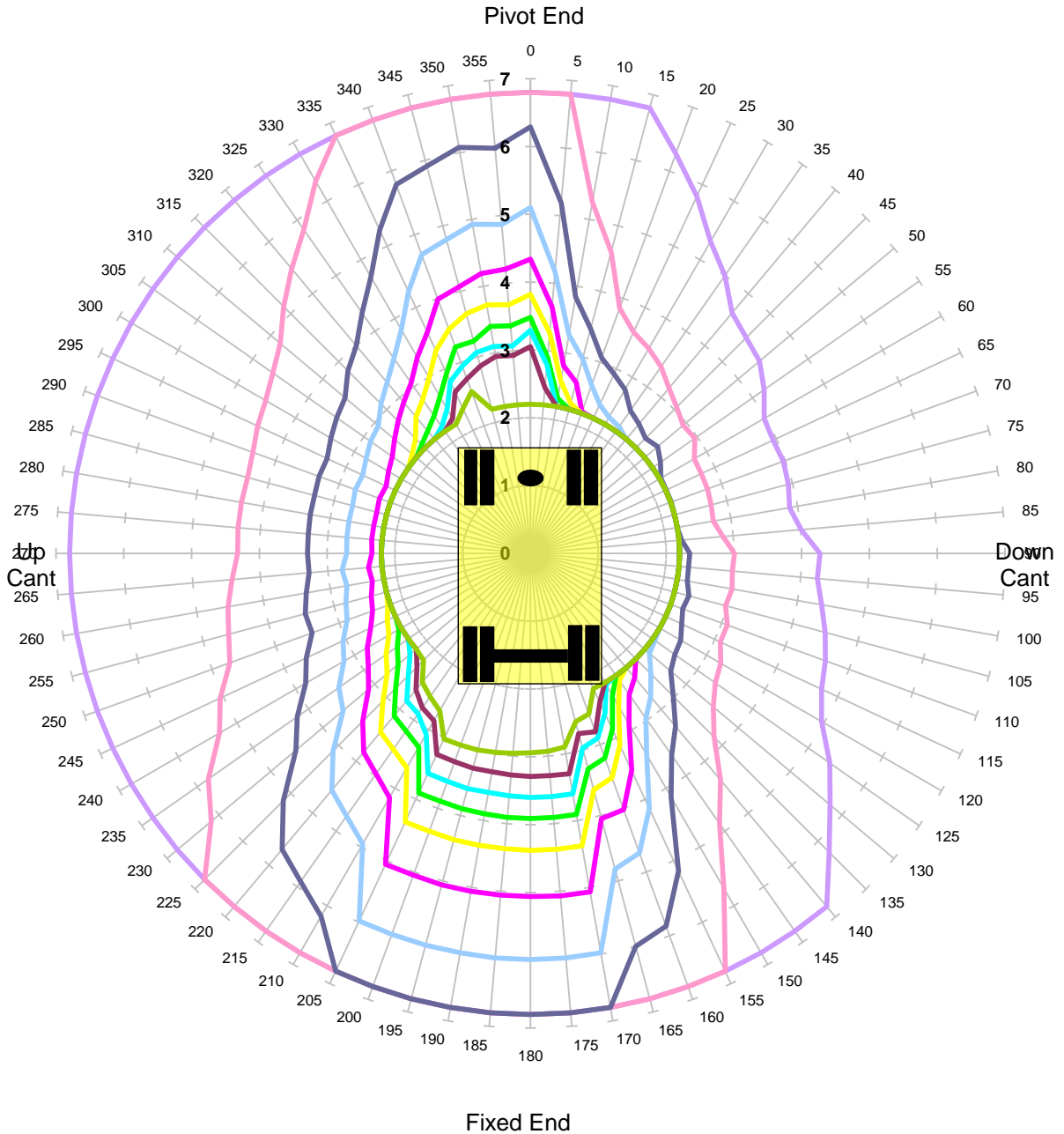

Units in Tonnes

- 1
 — 2
 — 3
 — 4
 — 5
 — 6
 — 7
 — 8
 — 9
 — 10

MACHINE & MODEL:	Volvo EW180	REFERENCE:	
SERIAL No:	8741012	DATE OF CHART:	4-Jun-2021
EQUIPMENT:	2.06m + 3.03m + 2.00m	SAFETY FACTOR:	67.0%
COMMENT:			

Volvo EW180
Max Capacity Contours of Radius(m) Plots 2.0m Dipper
Gradient 1 in -25 Height 2m Lift BP
Unlocked Rail Cant -50mm

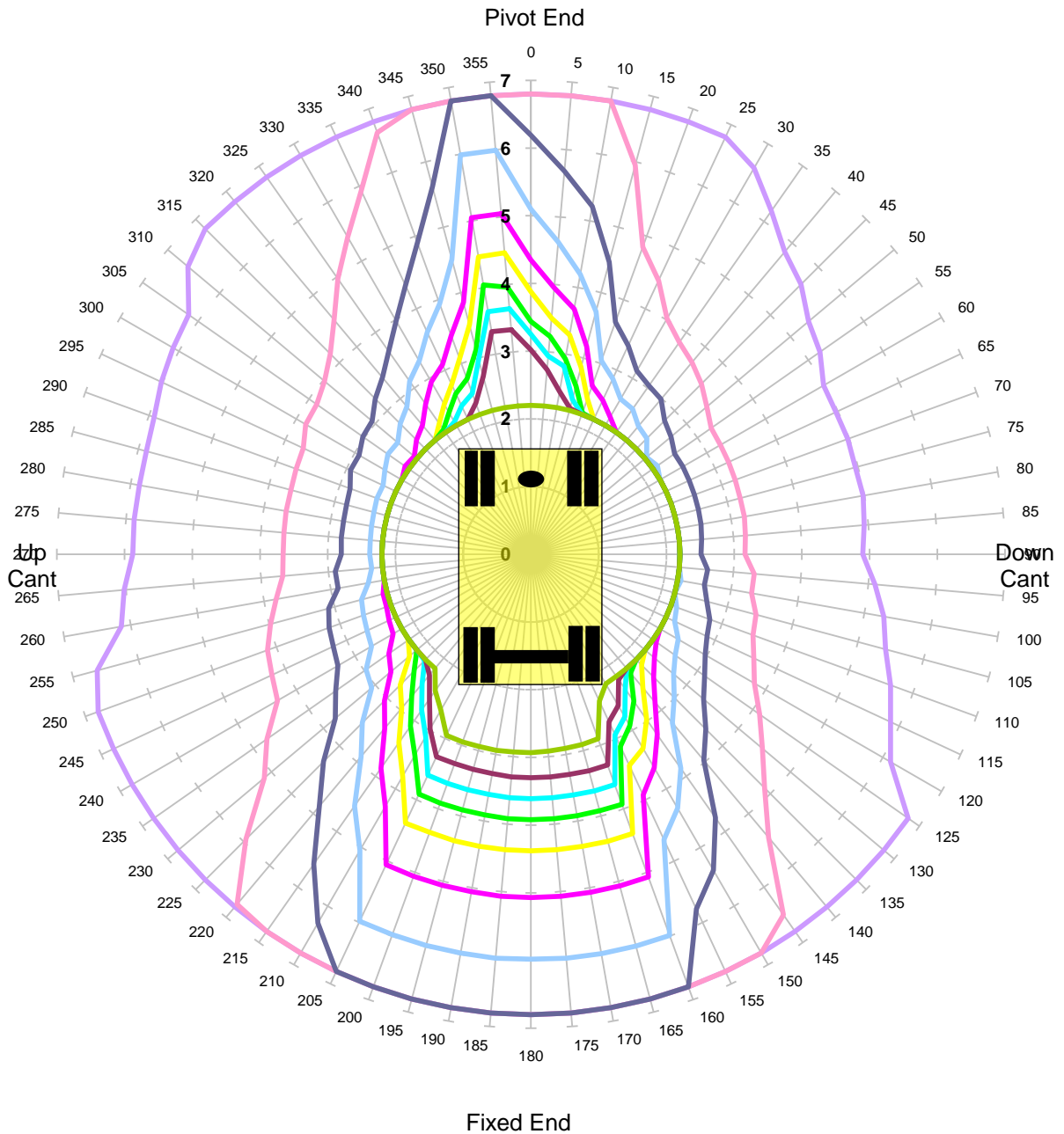

Units in Tonnes

- 1
 — 2
 — 3
 — 4
 — 5
 — 6
 — 7
 — 8
 — 9
 — 10

MACHINE & MODEL:	Volvo EW180	REFERENCE:	
SERIAL No:	8741012	DATE OF CHART:	4-Jun-2021
EQUIPMENT:	2.06m + 3.03m + 2.00m	SAFETY FACTOR:	67.0%
COMMENT:			

Volvo EW180
Max Capacity Contours of Radius(m) Plots 2.0m Dipper
Gradient 1 in -25 Height 2m Lift BP
Unlocked Rail Cant 50mm

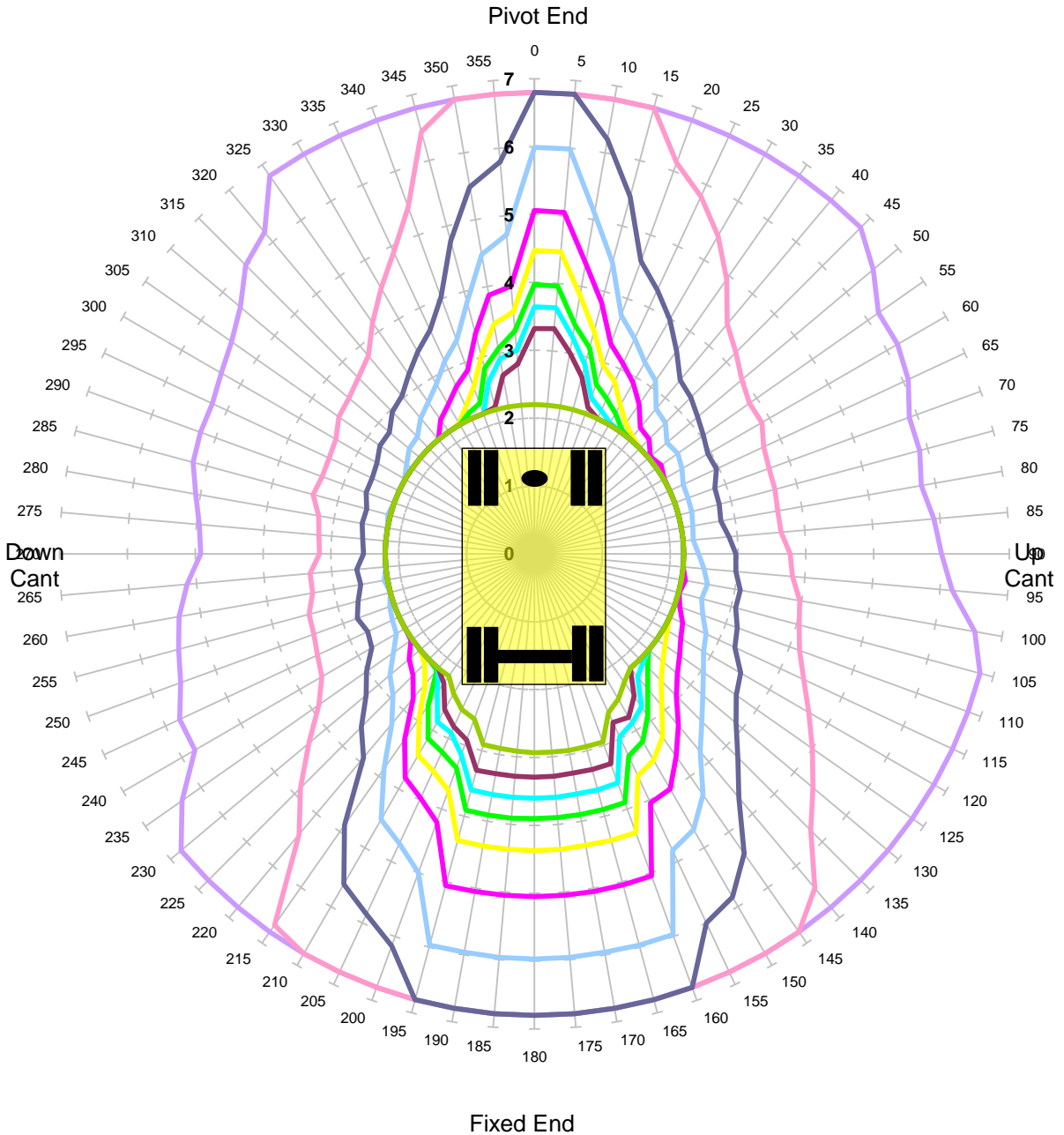

Units in Tonnes

- 1
- 2
- 3
- 4
- 5
- 6
- 7
- 8
- 9
- 10

MACHINE & MODEL:	Volvo EW180	REFERENCE:	
SERIAL No:	8741012	DATE OF CHART:	4-Jun-2021
EQUIPMENT:	2.06m + 3.03m + 2.00m	SAFETY FACTOR:	67.0%
COMMENT:			

Volvo EW180
Max Capacity Contours of Radius(m) Plots 2.0m Dipper
Gradient 1 in -25 Height 2m Lift BP
Unlocked Rail Cant 150mm

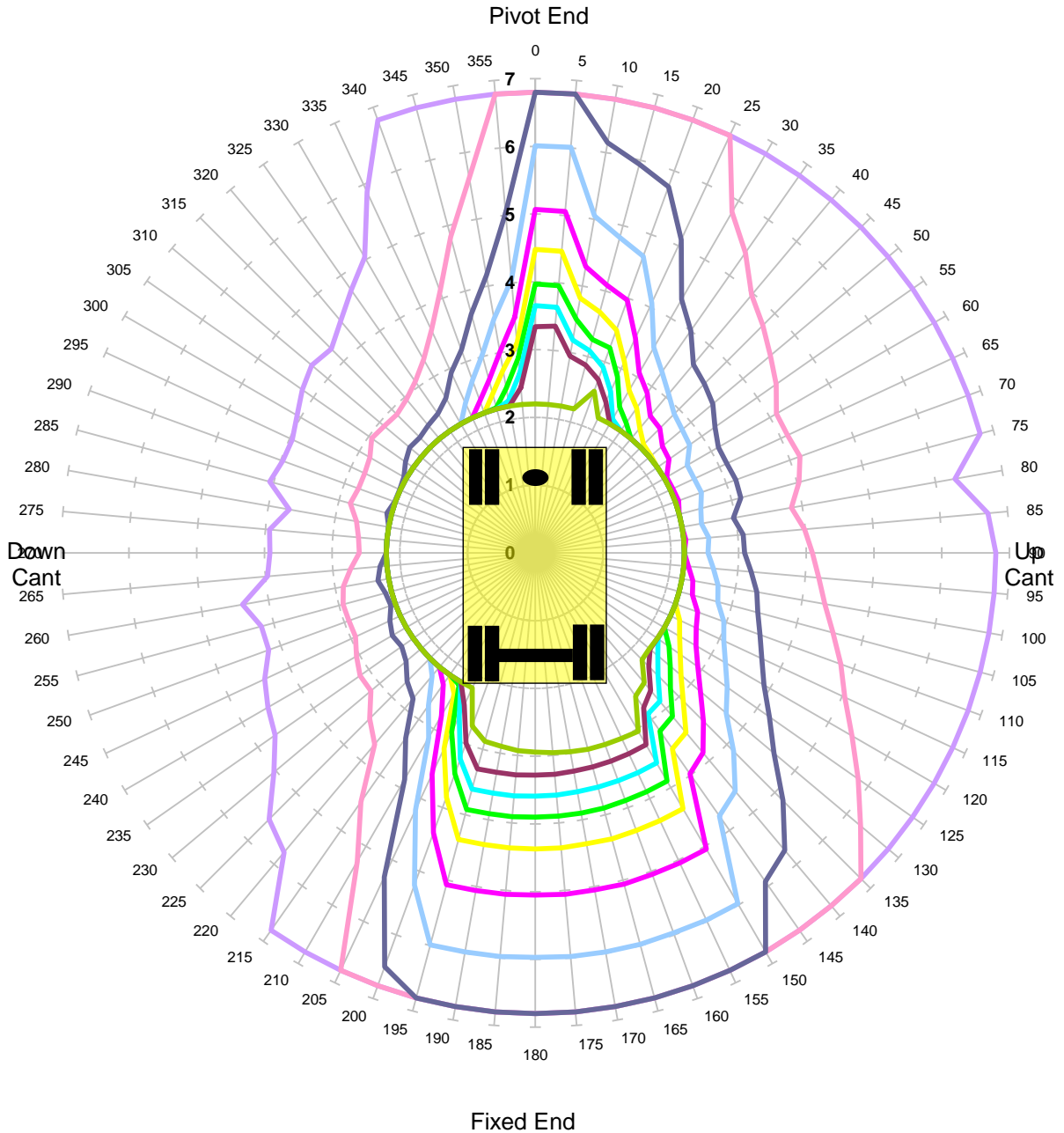

Units in Tonnes

- 1
- 2
- 3
- 4
- 5
- 6
- 7
- 8
- 9
- 10

MACHINE & MODEL:	Volvo EW180	REFERENCE:	
SERIAL No:	8741012	DATE OF CHART:	4-Jun-2021
EQUIPMENT:	2.06m + 3.03m + 2.00m	SAFETY FACTOR:	67.0%
COMMENT:			

Volvo EW180
Max Capacity Contours of Radius(m) Plots 2.0m Dipper
Gradient 1 in -25 Height 2m Lift BP
Locked Rail Cant -150mm

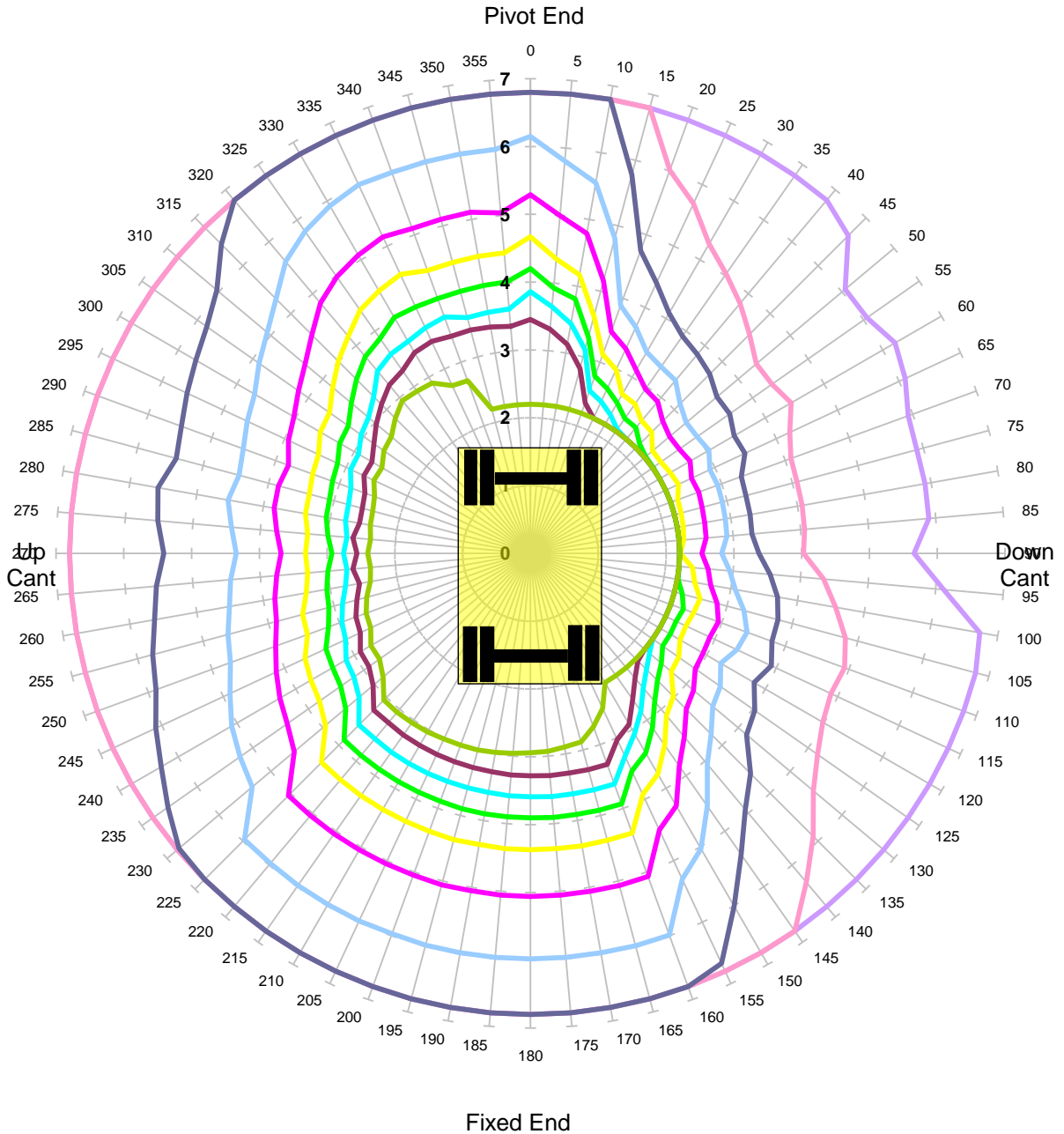

Units in Tonnes

- 1
- 2
- 3
- 4
- 5
- 6
- 7
- 8
- 9
- 10

MACHINE & MODEL:	Volvo EW180	REFERENCE:	
SERIAL No:	8741012	DATE OF CHART:	4-Jun-2021
EQUIPMENT:	2.06m + 3.03m + 2.00m	SAFETY FACTOR:	90.0%
COMMENT:			

Volvo EW180
Max Capacity Contours of Radius(m) Plots 2.0m Dipper
Gradient 1 in -25 Height 2m Lift BP
Locked Rail Cant -50mm

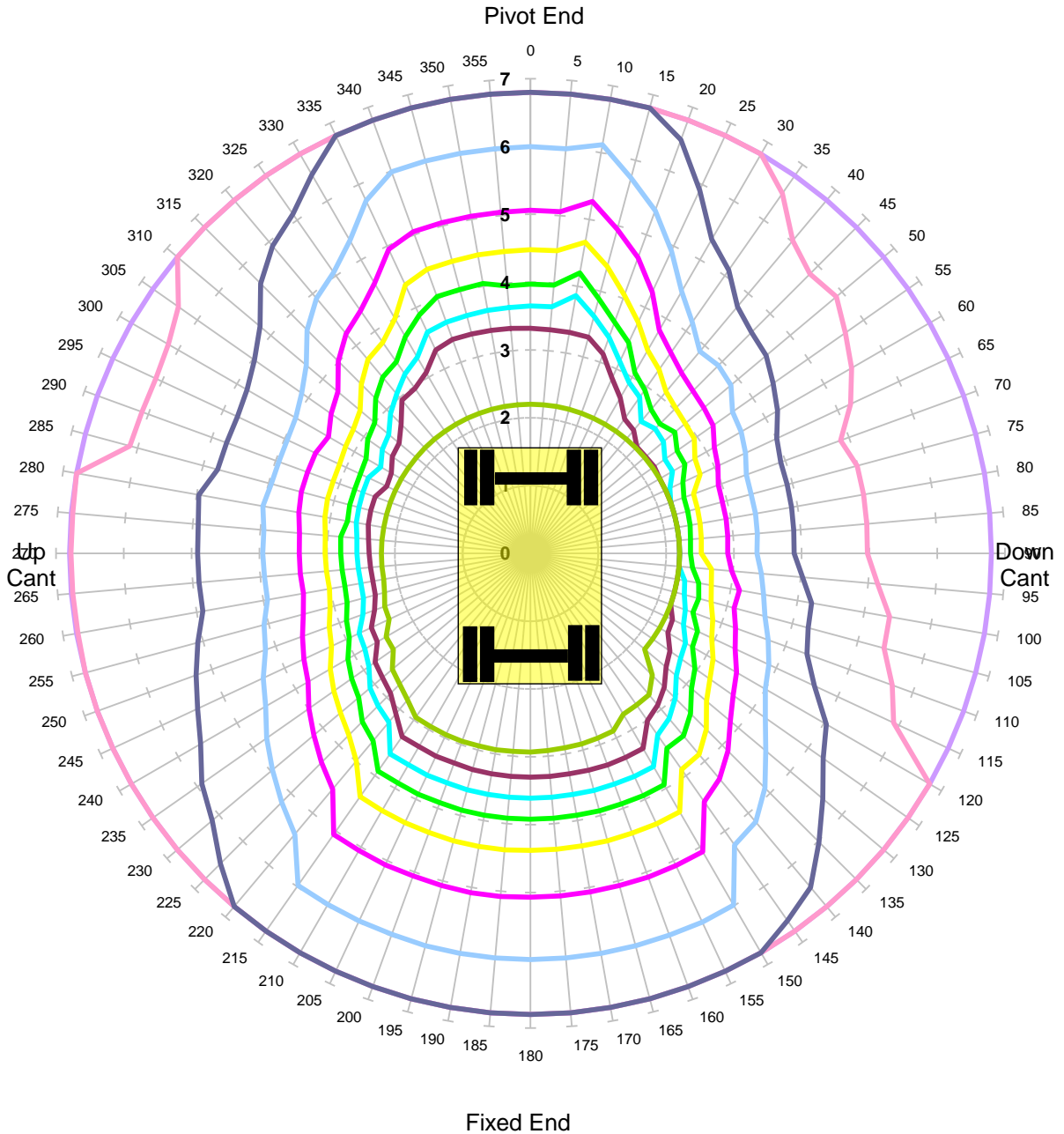

Units in Tonnes

- 1
- 2
- 3
- 4
- 5
- 6
- 7
- 8
- 9
- 10

MACHINE & MODEL:	Volvo EW180	REFERENCE:	
SERIAL No:	8741012	DATE OF CHART:	4-Jun-2021
EQUIPMENT:	2.06m + 3.03m + 2.00m	SAFETY FACTOR:	90.0%
COMMENT:			

Volvo EW180
Max Capacity Contours of Radius(m) Plots 2.0m Dipper
Gradient 1 in -25 Height 2m Lift BP
Locked Rail Cant 50mm

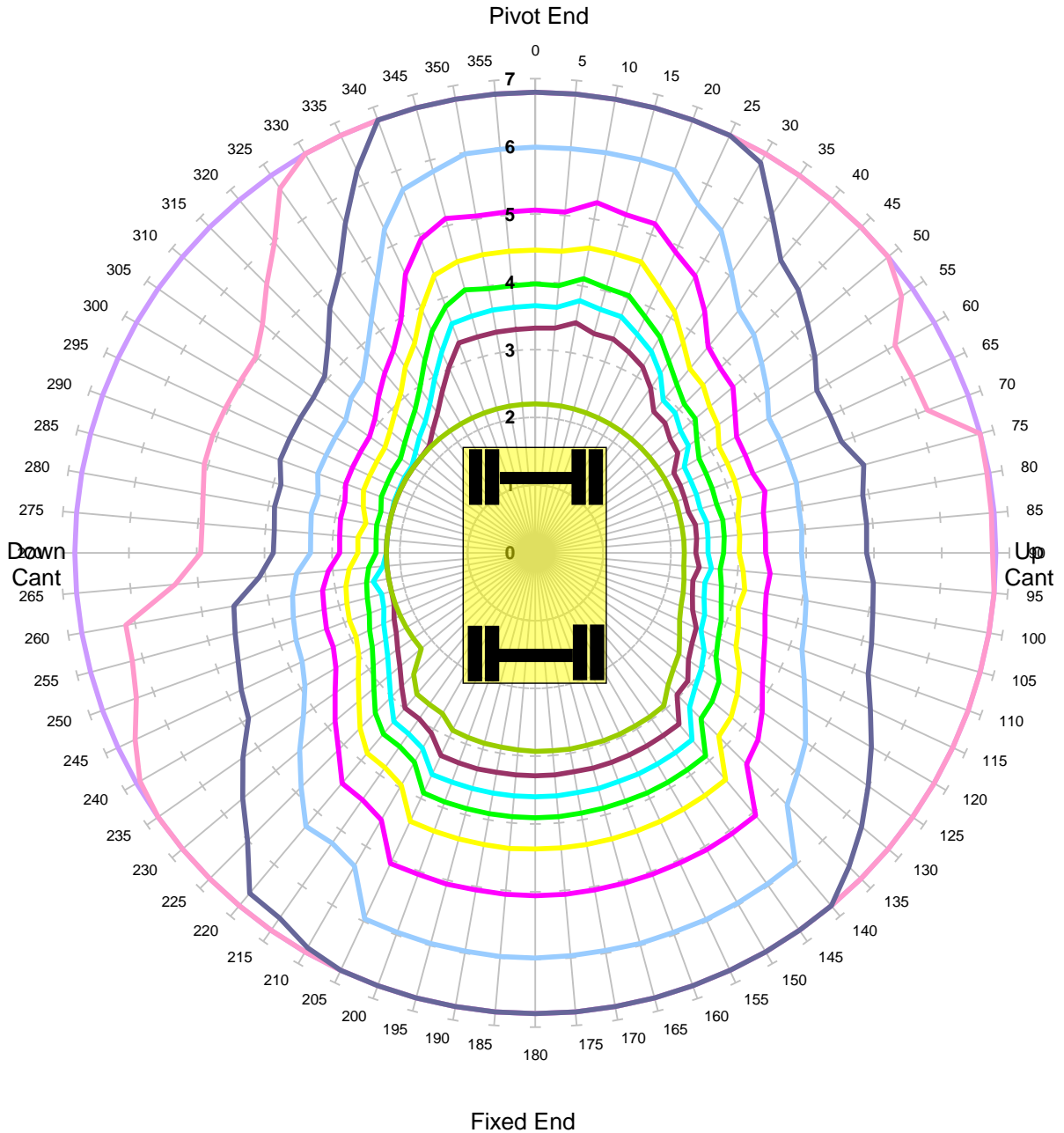

Units in Tonnes

- 1
- 2
- 3
- 4
- 5
- 6
- 7
- 8
- 9
- 10

MACHINE & MODEL:	Volvo EW180	REFERENCE:	
SERIAL No:	8741012	DATE OF CHART:	4-Jun-2021
EQUIPMENT:	2.06m + 3.03m + 2.00m	SAFETY FACTOR:	90.0%
COMMENT:			

Volvo EW180
Max Capacity Contours of Radius(m) Plots 2.0m Dipper
Gradient 1 in -25 Height 2m Lift BP
Locked Rail Cant 150mm

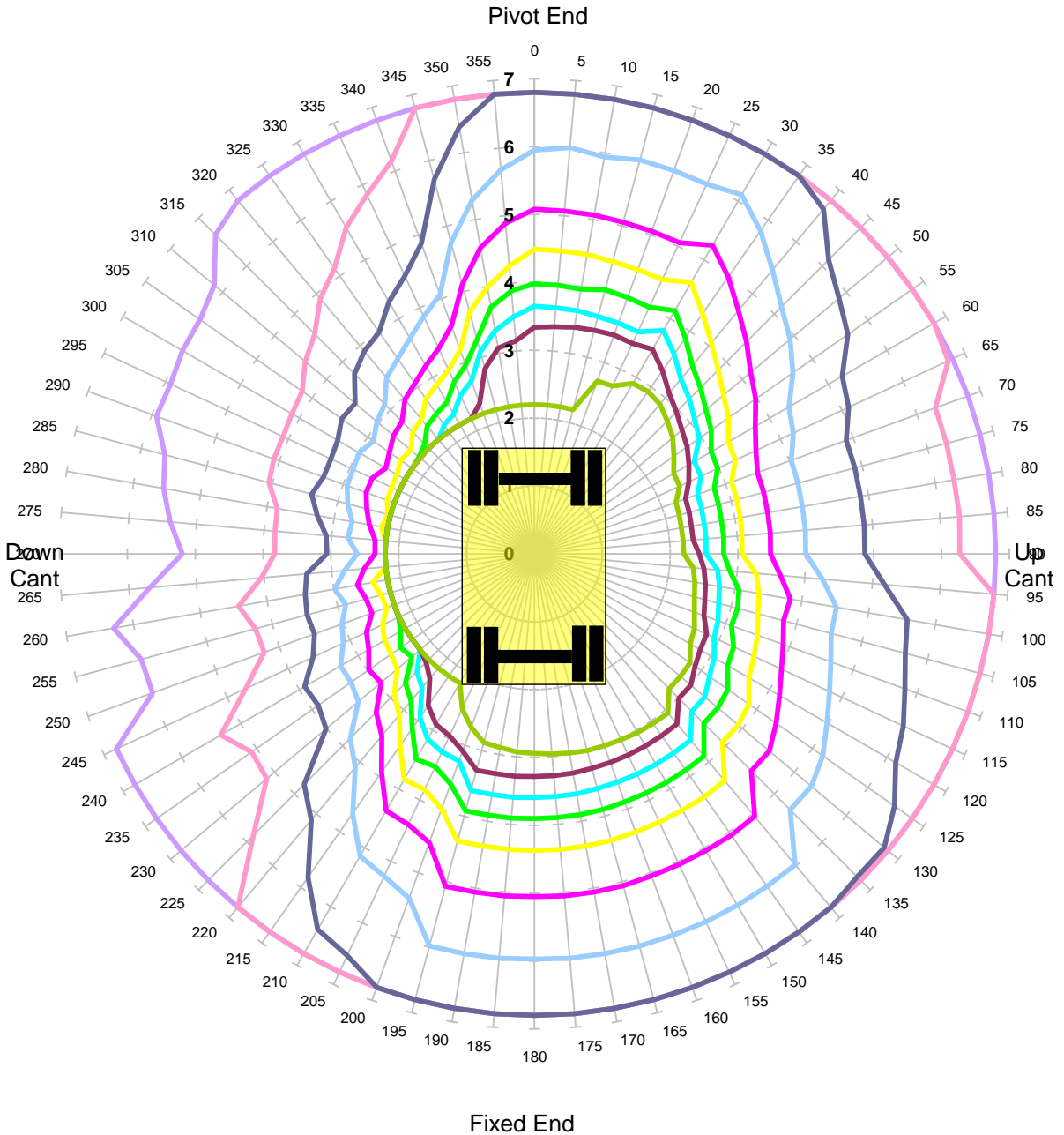

Units in Tonnes

- 1
- 2
- 3
- 4
- 5
- 6
- 7
- 8
- 9
- 10

MACHINE & MODEL:	Volvo EW180	REFERENCE:	
SERIAL No:	8741012	DATE OF CHART:	4-Jun-2021
EQUIPMENT:	2.06m + 3.03m + 2.00m	SAFETY FACTOR:	90.0%
COMMENT:			

Volvo EW180
Max Capacity Contours of Radius(m) Plots 2.0m Dipper
Level Ground Height 2m Lift BP
Unlocked Road

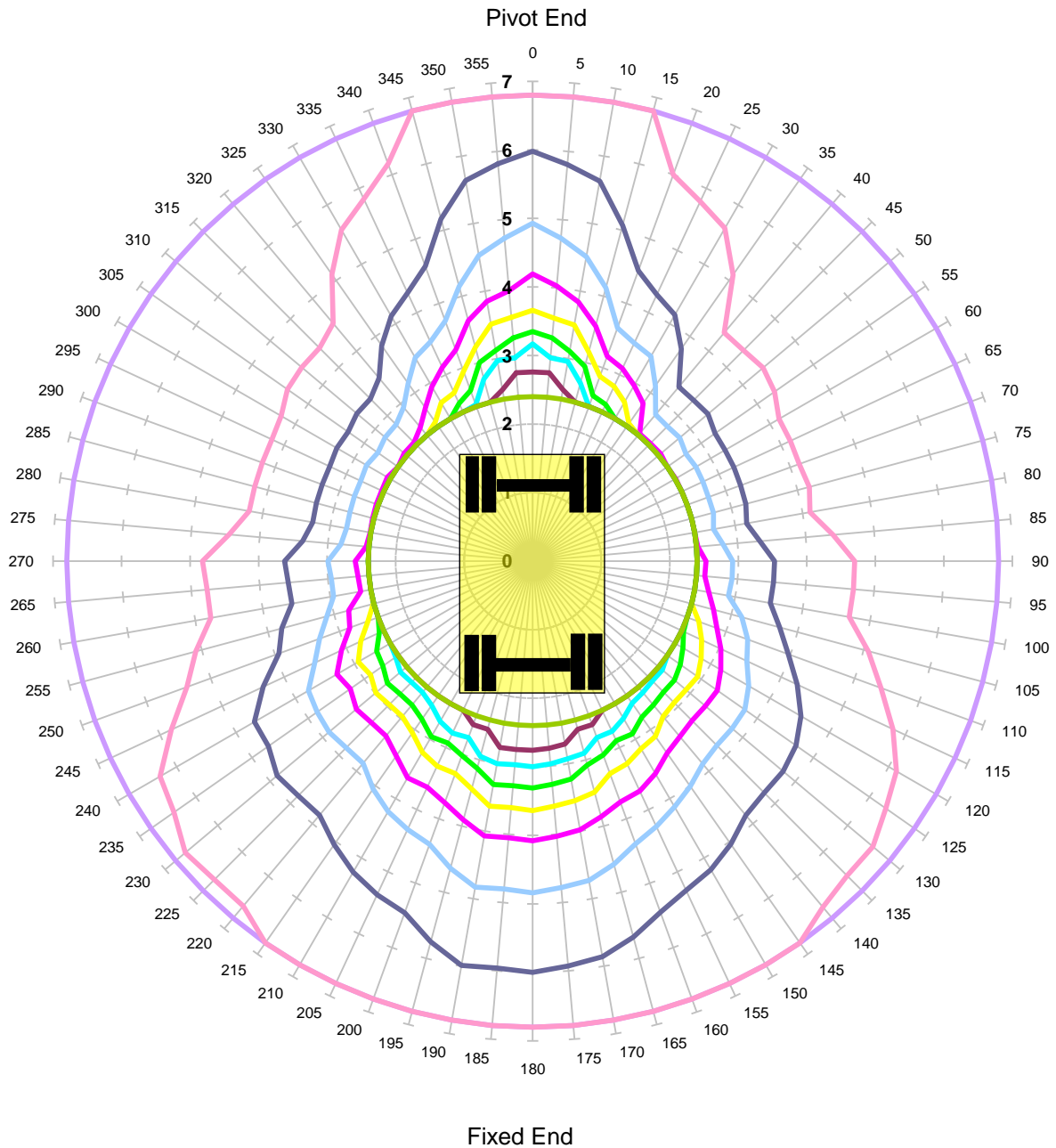

Units in Tonnes

- 1
- 2
- 3
- 4
- 5
- 6
- 7
- 8
- 9
- 10

MACHINE & MODEL:	Volvo EW180	REFERENCE:	
SERIAL No:	8741012	DATE OF CHART:	4-Jun-2021
EQUIPMENT:	2.06m + 3.03m + 2.00m	SAFETY FACTOR:	71.0%
COMMENT:			

Volvo EW180
Max Capacity Contours of Radius(m) Plots 2.0m Dipper
Level Ground Height 2m Lift BP
Locked Road

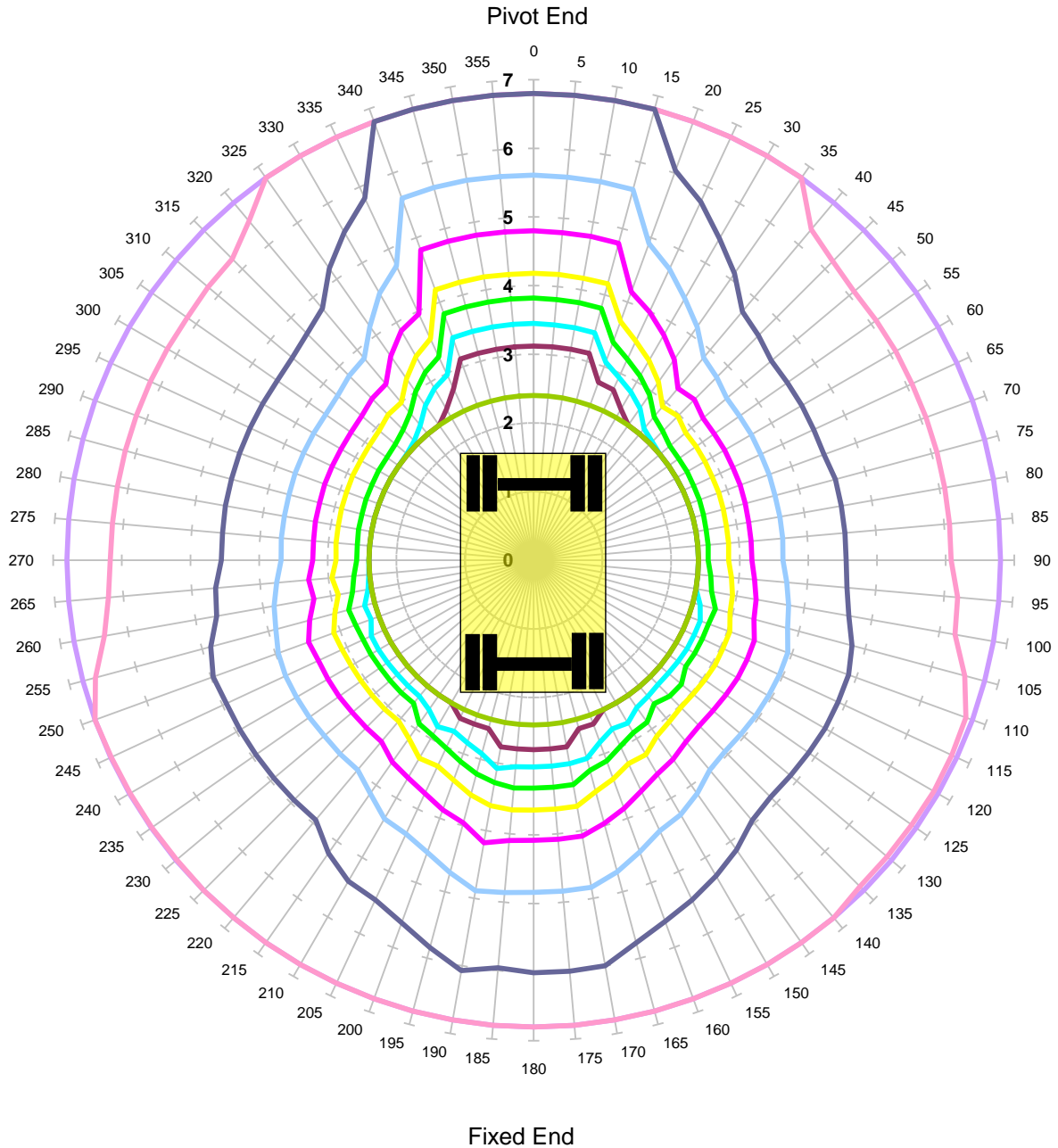

Units in Tonnes

- 1
- 2
- 3
- 4
- 5
- 6
- 7
- 8
- 9
- 10

MACHINE & MODEL:	Volvo EW180	REFERENCE:	
SERIAL No:	8741012	DATE OF CHART:	4-Jun-2021
EQUIPMENT:	2.06m + 3.03m + 2.00m	SAFETY FACTOR:	71.0%
COMMENT:			

Volvo EW180
Max Capacity Contours of Radius(m) Plots 2.0m Dipper
Gradient 1 in -25 Height 2m Lift BP
Unlocked Rail Cant -150mm - Tandem Lift

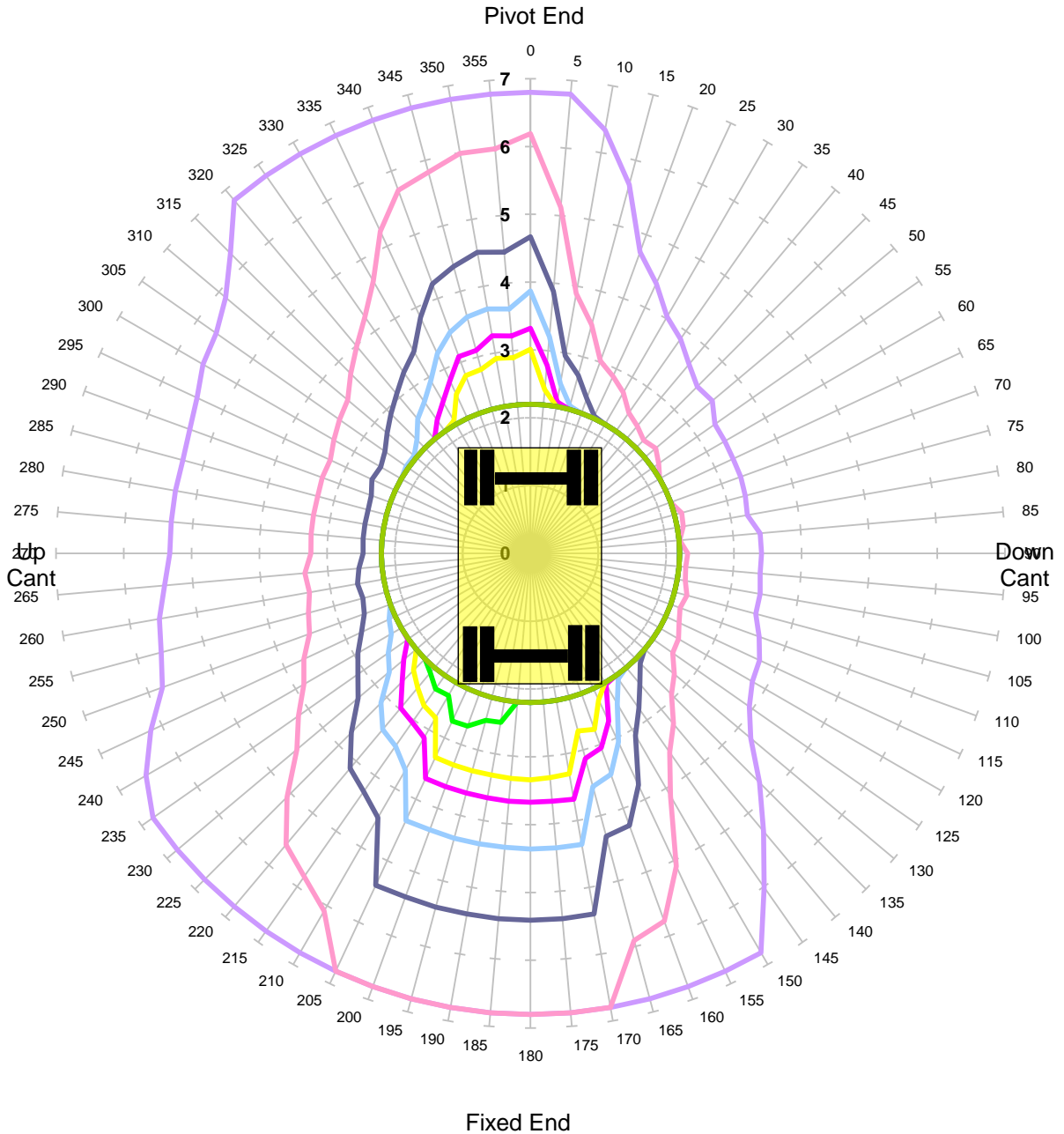

Units in Tonnes

- 1
 — 2
 — 3
 — 4
 — 5
 — 6
 — 7
 — 8
 — 9
 — 10

MACHINE & MODEL:	Volvo EW180	REFERENCE:	
SERIAL No:	8741012	DATE OF CHART:	4-Jun-2021
EQUIPMENT:	2.06m + 3.03m + 2.00m	SAFETY FACTOR:	44.0%
COMMENT:			

Volvo EW180
Max Capacity Contours of Radius(m) Plots 2.0m Dipper
Gradient 1 in -25 Height 2m Lift BP
Unlocked Rail Cant -50mm - Tandem Lift

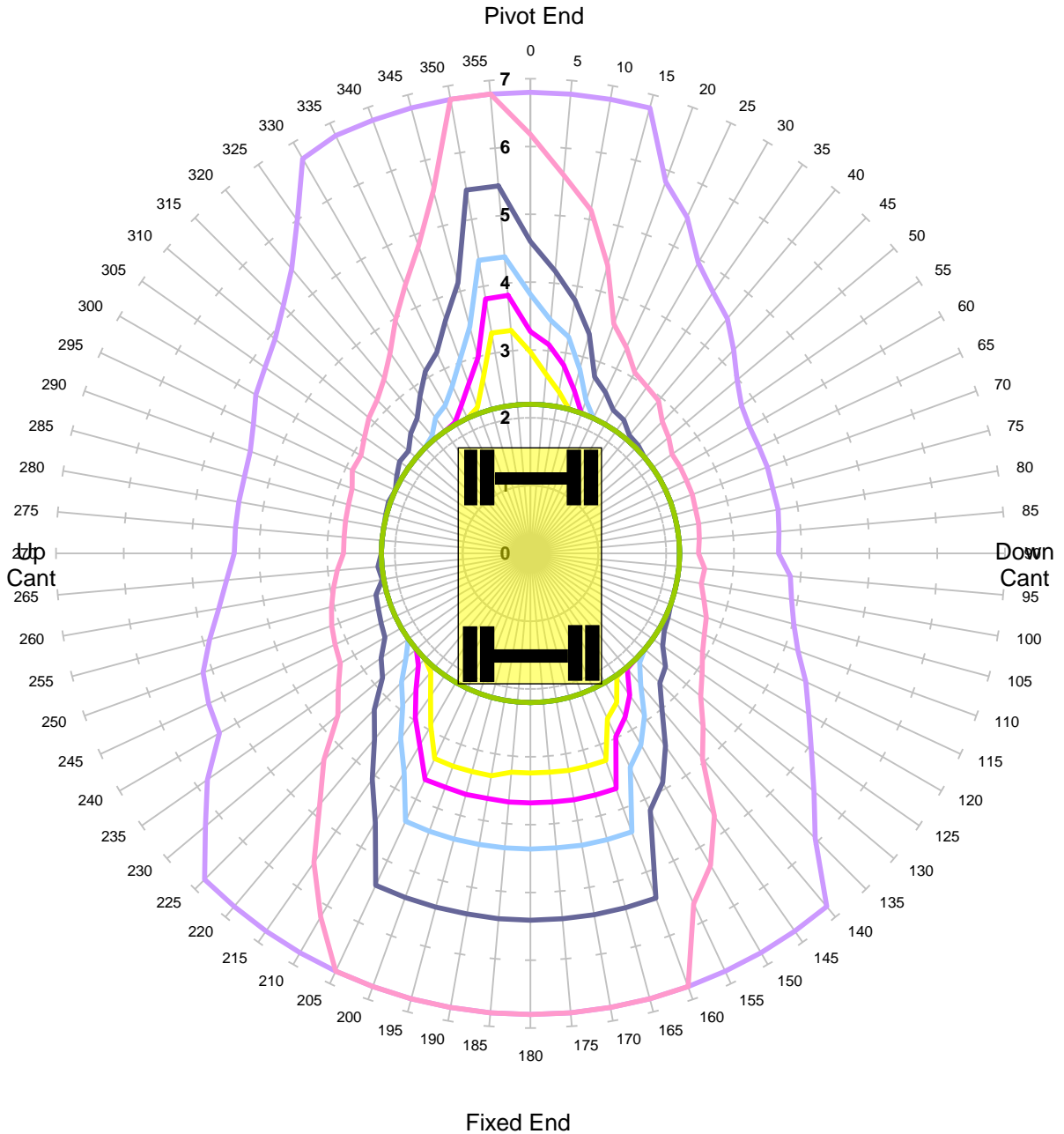

Units in Tonnes

- 1
- 2
- 3
- 4
- 5
- 6
- 7
- 8
- 9
- 10

MACHINE & MODEL:	Volvo EW180	REFERENCE:	
SERIAL No:	8741012	DATE OF CHART:	4-Jun-2021
EQUIPMENT:	2.06m + 3.03m + 2.00m	SAFETY FACTOR:	44.0%
COMMENT:			

Volvo EW180
Max Capacity Contours of Radius(m) Plots 2.0m Dipper
Gradient 1 in -25 Height 2m Lift BP
Unlocked Rail Cant 50mm - Tandem Lift

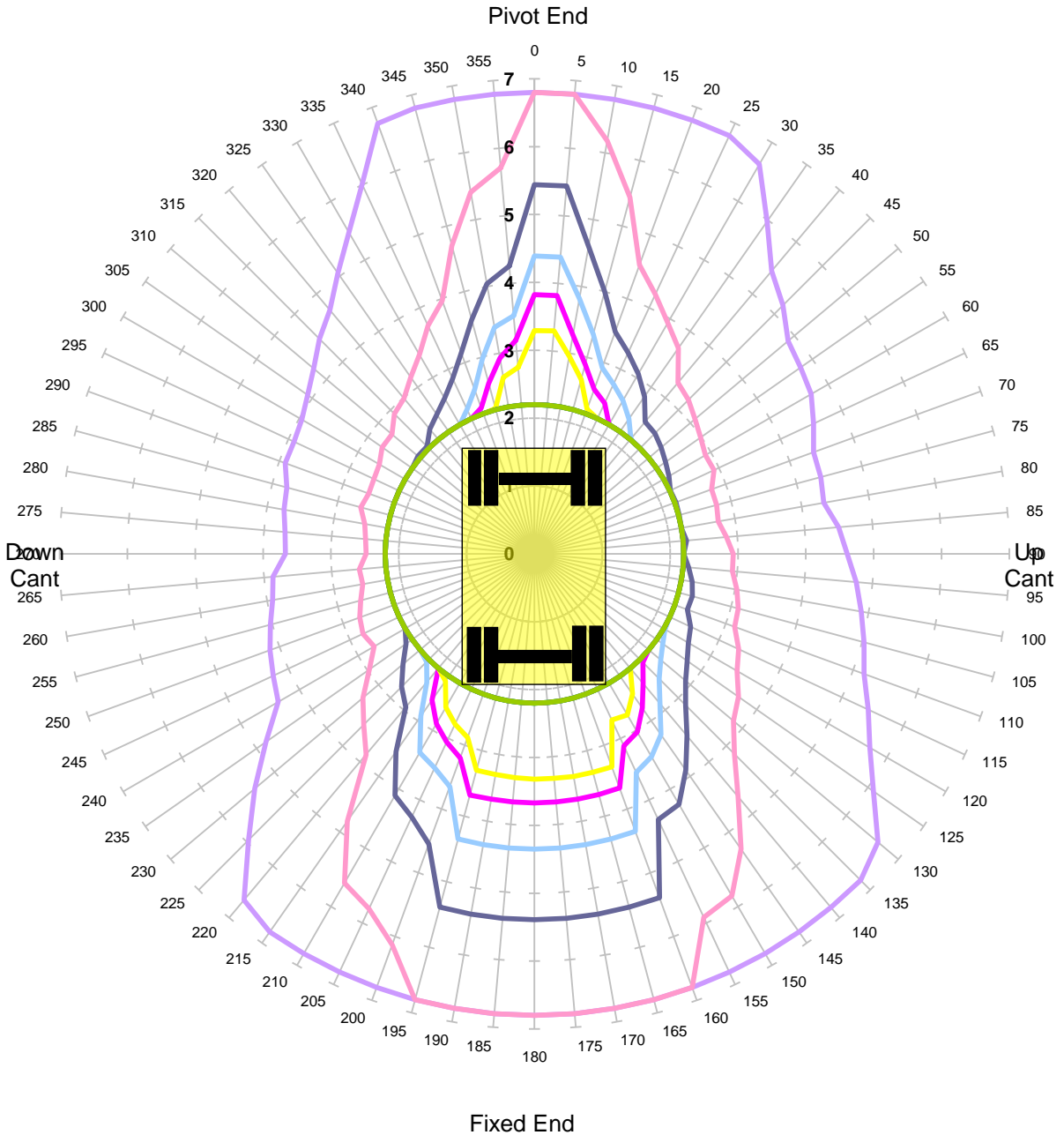

Units in Tonnes

- 1
- 2
- 3
- 4
- 5
- 6
- 7
- 8
- 9
- 10

MACHINE & MODEL:	Volvo EW180	REFERENCE:	
SERIAL No:	8741012	DATE OF CHART:	4-Jun-2021
EQUIPMENT:	2.06m + 3.03m + 2.00m	SAFETY FACTOR:	44.0%
COMMENT:			

Volvo EW180
Max Capacity Contours of Radius(m) Plots 2.0m Dipper
Gradient 1 in -25 Height 2m Lift BP
Unlocked Rail Cant 150mm - Tandem Lift

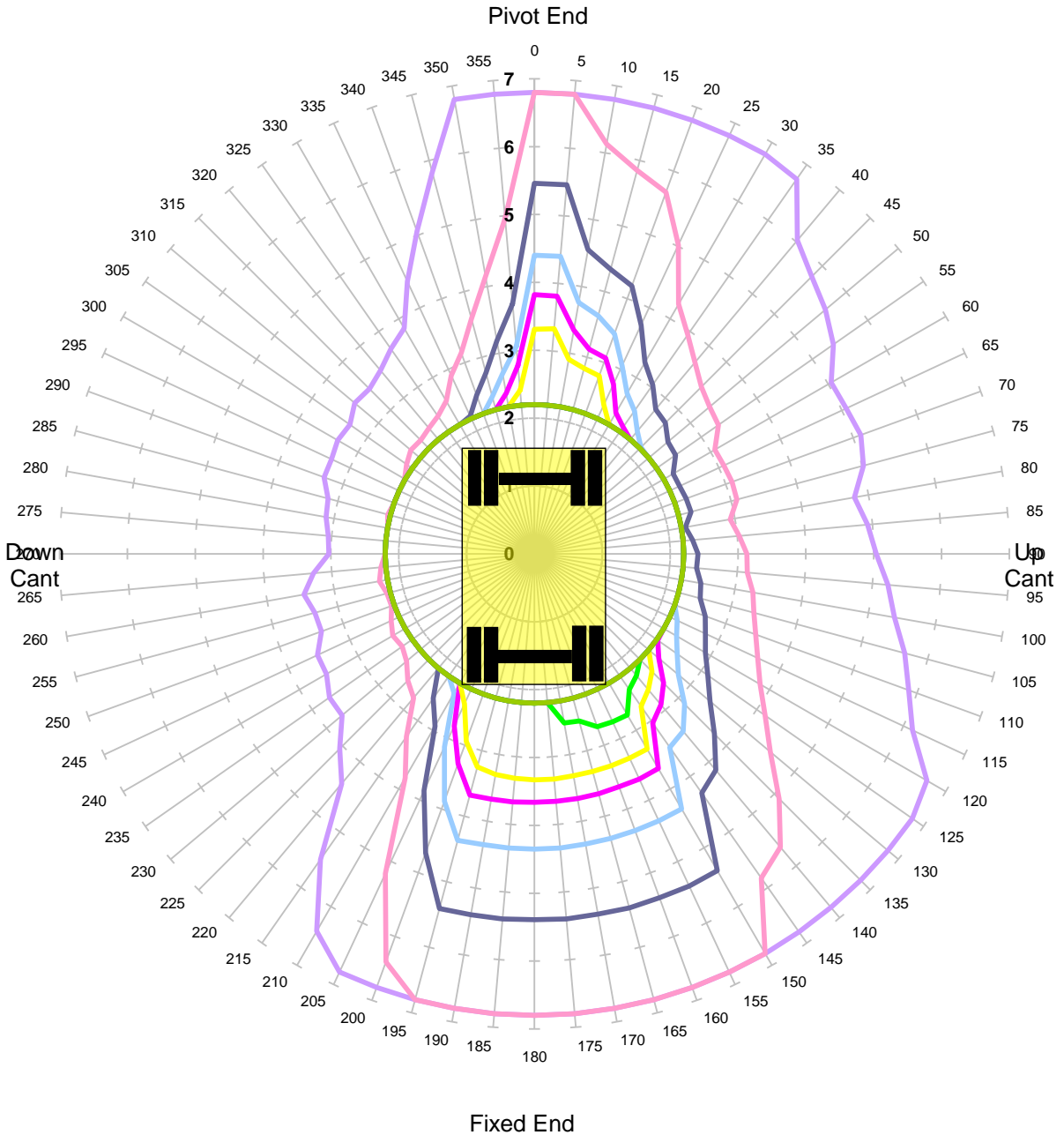

Units in Tonnes

- 1
 — 2
 — 3
 — 4
 — 5
 — 6
 — 7
 — 8
 — 9
 — 10

MACHINE & MODEL:	Volvo EW180	REFERENCE:	
SERIAL No:	8741012	DATE OF CHART:	4-Jun-2021
EQUIPMENT:	2.06m + 3.03m + 2.00m	SAFETY FACTOR:	44.0%
COMMENT:			

Volvo EW180
Max Capacity Contours of Radius(m) Plots 2.0m Dipper
Gradient 1 in -25 Height 2m Lift BP
Locked Rail Cant -150mm - Tandem Lift

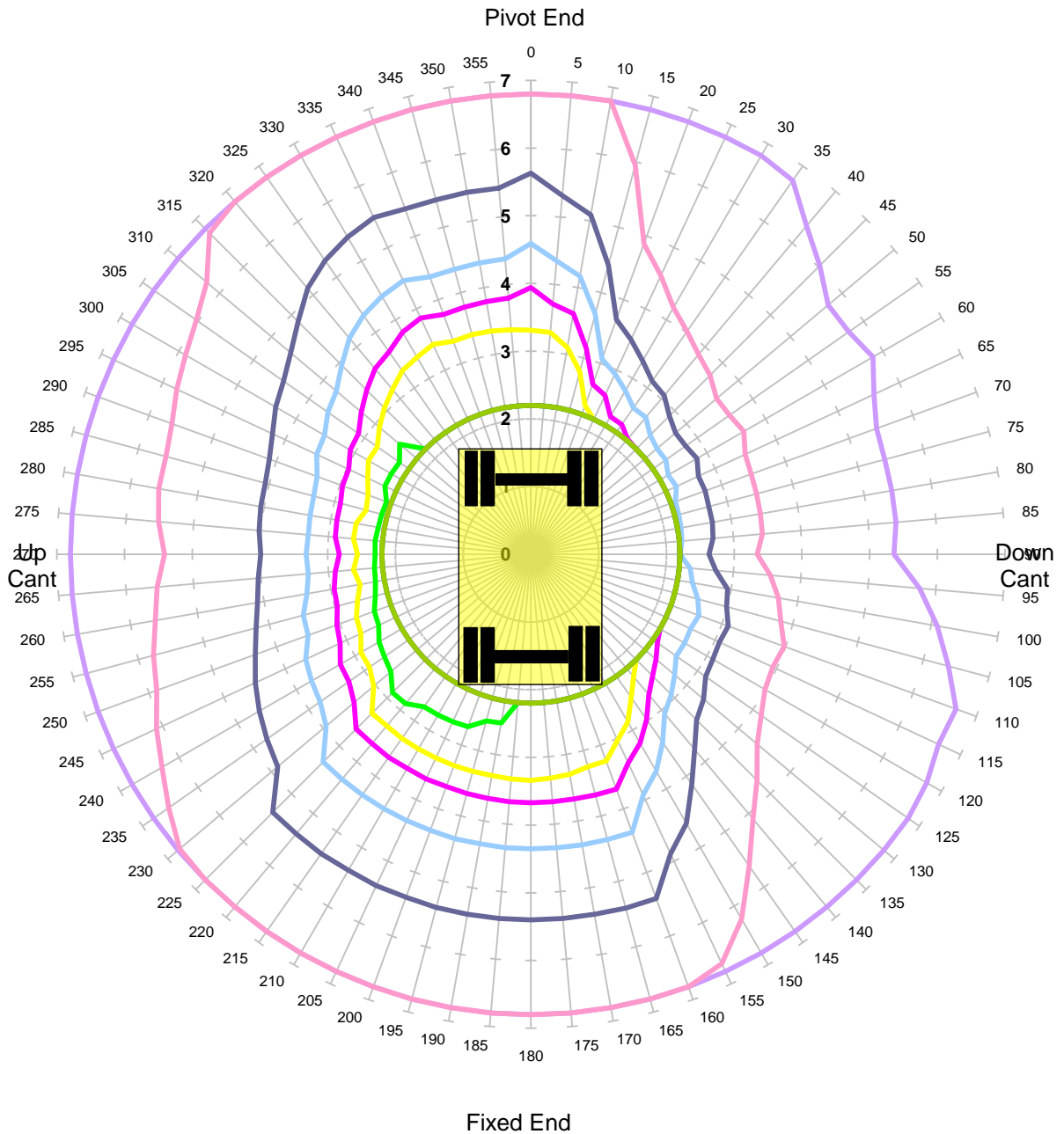

Units in Tonnes

- 1
- 2
- 3
- 4
- 5
- 6
- 7
- 8
- 9
- 10

MACHINE & MODEL:	Volvo EW180	REFERENCE:	
SERIAL No:	8741012	DATE OF CHART:	4-Jun-2021
EQUIPMENT:	2.06m + 3.03m + 2.00m	SAFETY FACTOR:	59.0%
COMMENT:			

Volvo EW180
Max Capacity Contours of Radius(m) Plots 2.0m Dipper
Gradient 1 in -25 Height 2m Lift BP
Locked Rail Cant -50mm - Tandem Lift

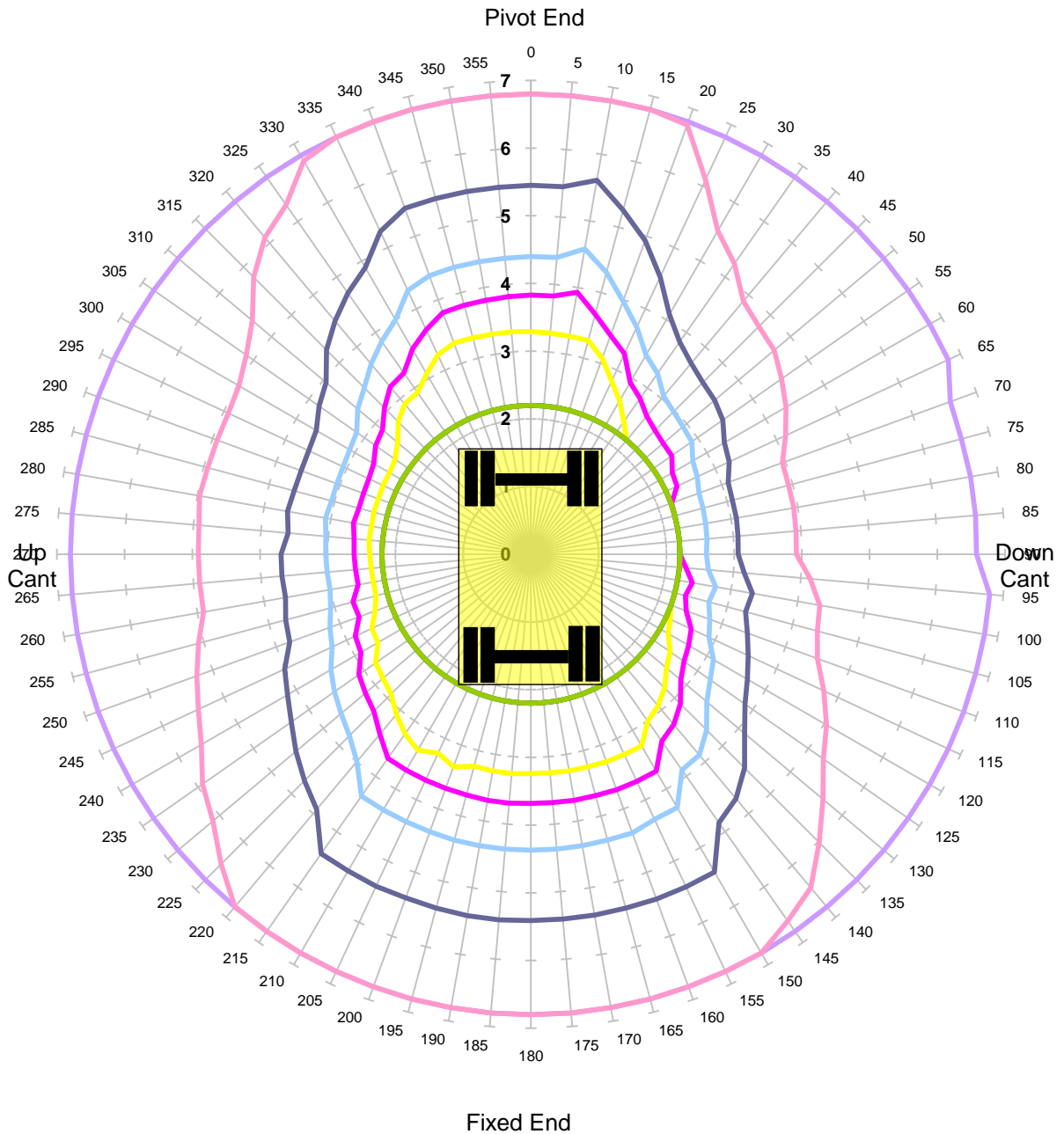

Units in Tonnes

- 1
 — 2
 — 3
 — 4
 — 5
 — 6
 — 7
 — 8
 — 9
 — 10

MACHINE & MODEL:	Volvo EW180	REFERENCE:	
SERIAL No:	8741012	DATE OF CHART:	4-Jun-2021
EQUIPMENT:	2.06m + 3.03m + 2.00m	SAFETY FACTOR:	59.0%
COMMENT:			

Volvo EW180
Max Capacity Contours of Radius(m) Plots 2.0m Dipper
Gradient 1 in -25 Height 2m Lift BP
Locked Rail Cant 50mm - Tandem Lift

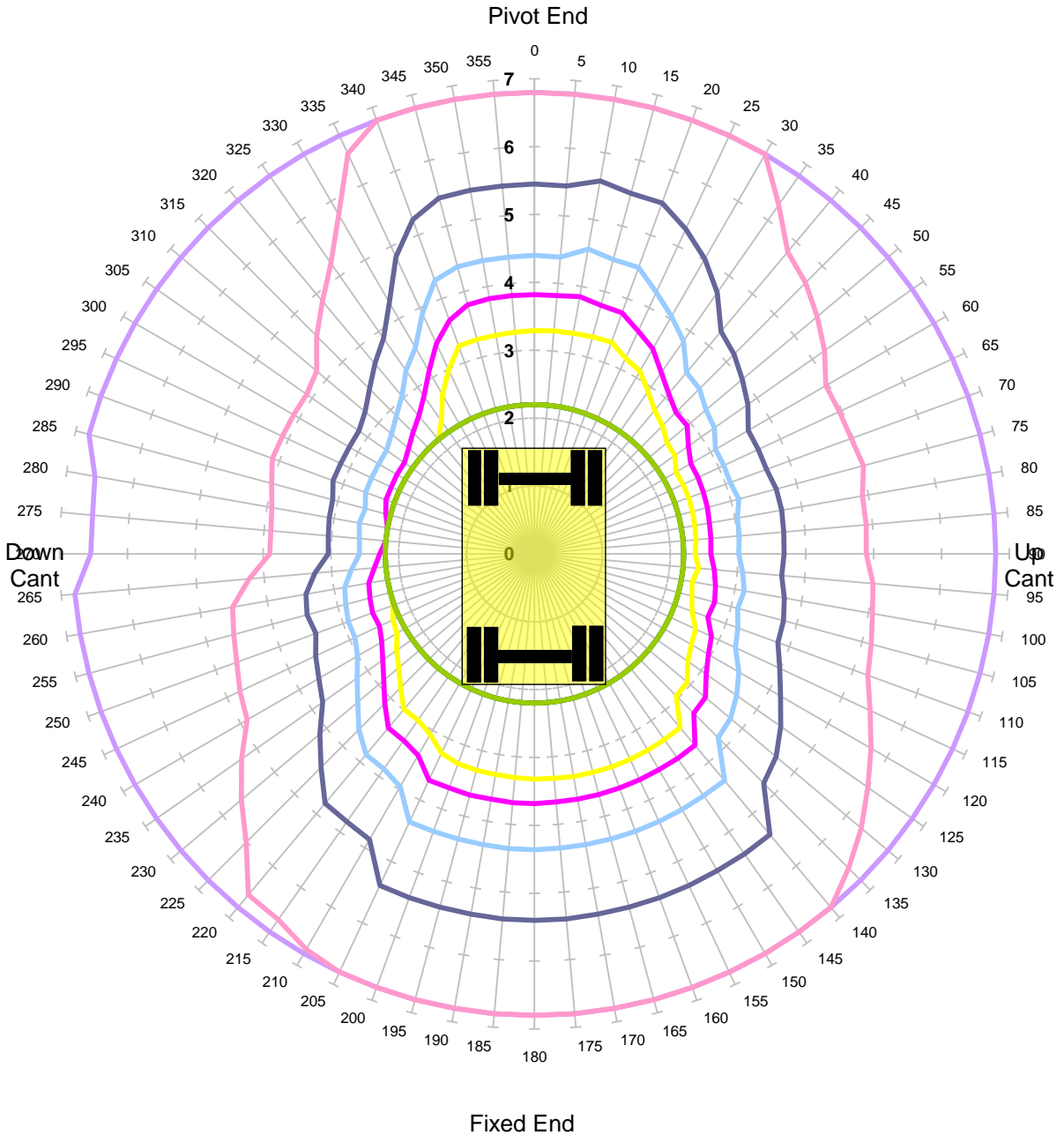

Units in Tonnes

- 1
- 2
- 3
- 4
- 5
- 6
- 7
- 8
- 9
- 10

MACHINE & MODEL:	Volvo EW180	REFERENCE:	
SERIAL No:	8741012	DATE OF CHART:	4-Jun-2021
EQUIPMENT:	2.06m + 3.03m + 2.00m	SAFETY FACTOR:	59.0%
COMMENT:			

Volvo EW180
Max Capacity Contours of Radius(m) Plots 2.0m Dipper
Gradient 1 in -25 Height 2m Lift BP
Locked Rail Cant 150mm - Tandem Lift

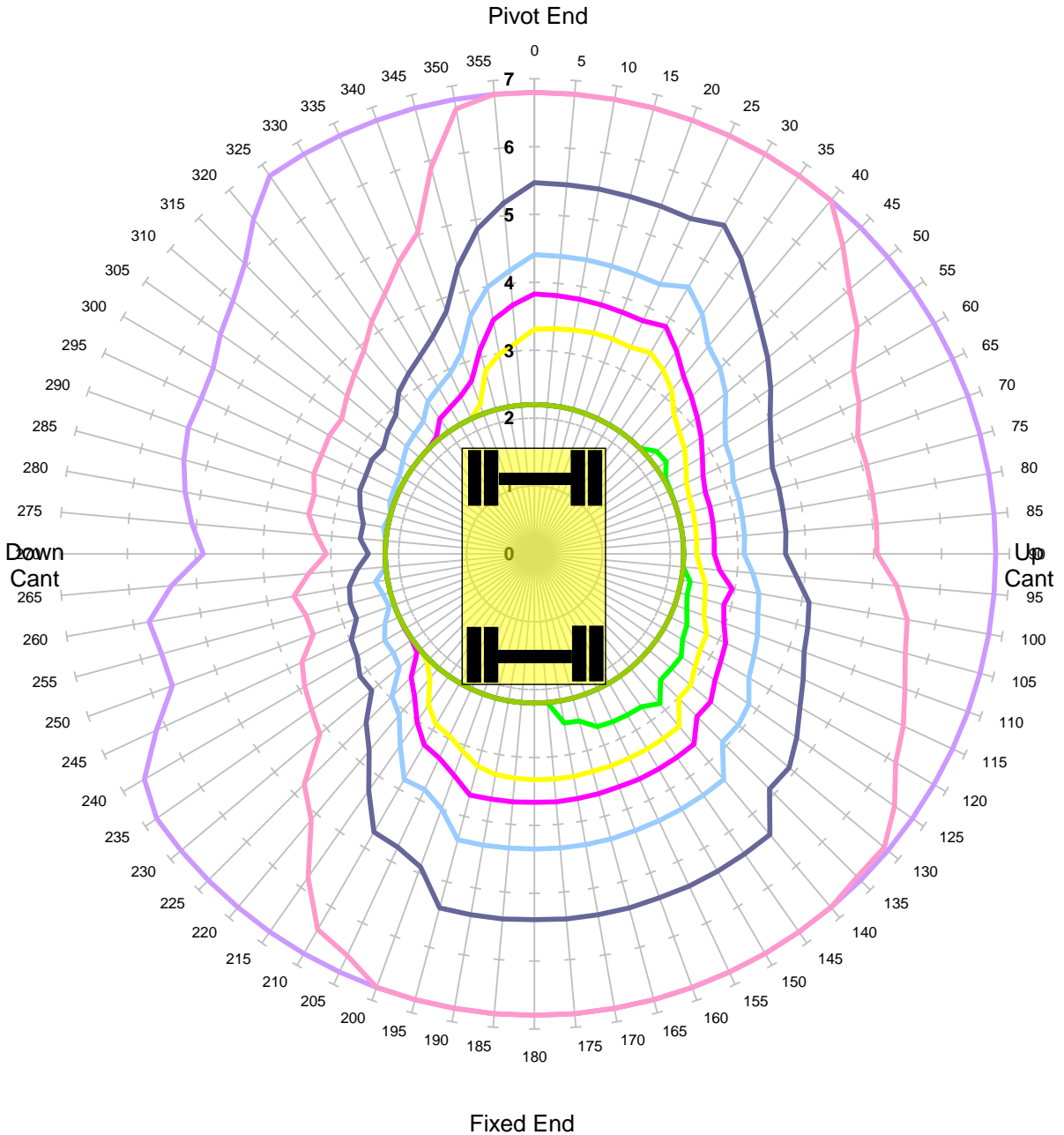

Units in Tonnes

- 1
- 2
- 3
- 4
- 5
- 6
- 7
- 8
- 9
- 10

MACHINE & MODEL:	Volvo EW180	REFERENCE:	
SERIAL No:	8741012	DATE OF CHART:	4-Jun-2021
EQUIPMENT:	2.06m + 3.03m + 2.00m	SAFETY FACTOR:	59.0%
COMMENT:			

Volvo EW180
Max Capacity Contours of Radius(m) Plots 2.0m Dipper
Level Ground Height 2m Lift BP
Unlocked Road - Tandem Lift

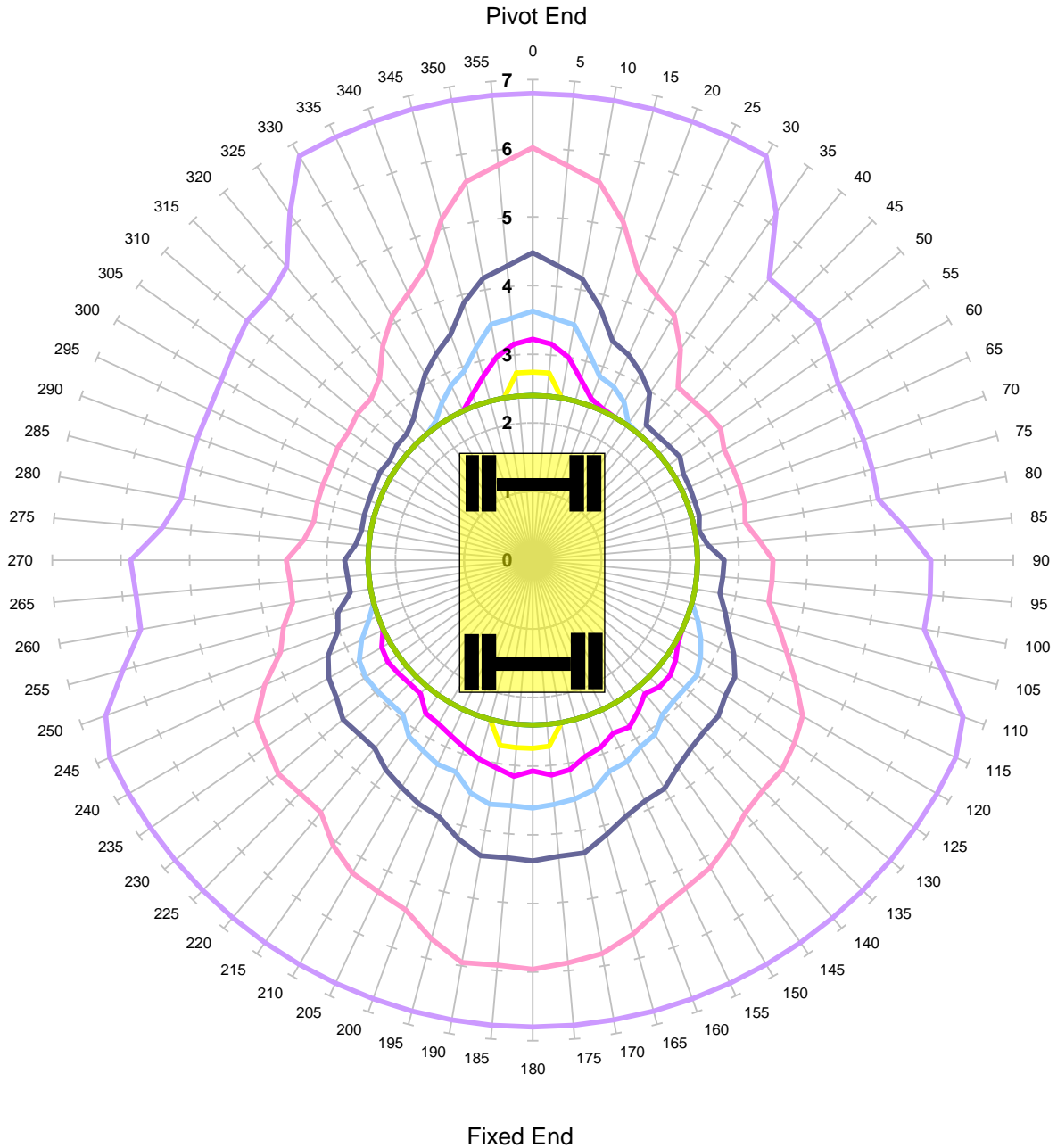

Units in Tonnes

- 1
- 2
- 3
- 4
- 5
- 6
- 7
- 8
- 9
- 10

MACHINE & MODEL:	Volvo EW180	REFERENCE:	
SERIAL No:	8741012	DATE OF CHART:	4-Jun-2021
EQUIPMENT:	2.06m + 3.03m + 2.00m	SAFETY FACTOR:	47.0%
COMMENT:			

Volvo EW180
Max Capacity Contours of Radius(m) Plots 2.0m Dipper
Level Ground Height 2m Lift BP
Locked Road - Tandem Lift

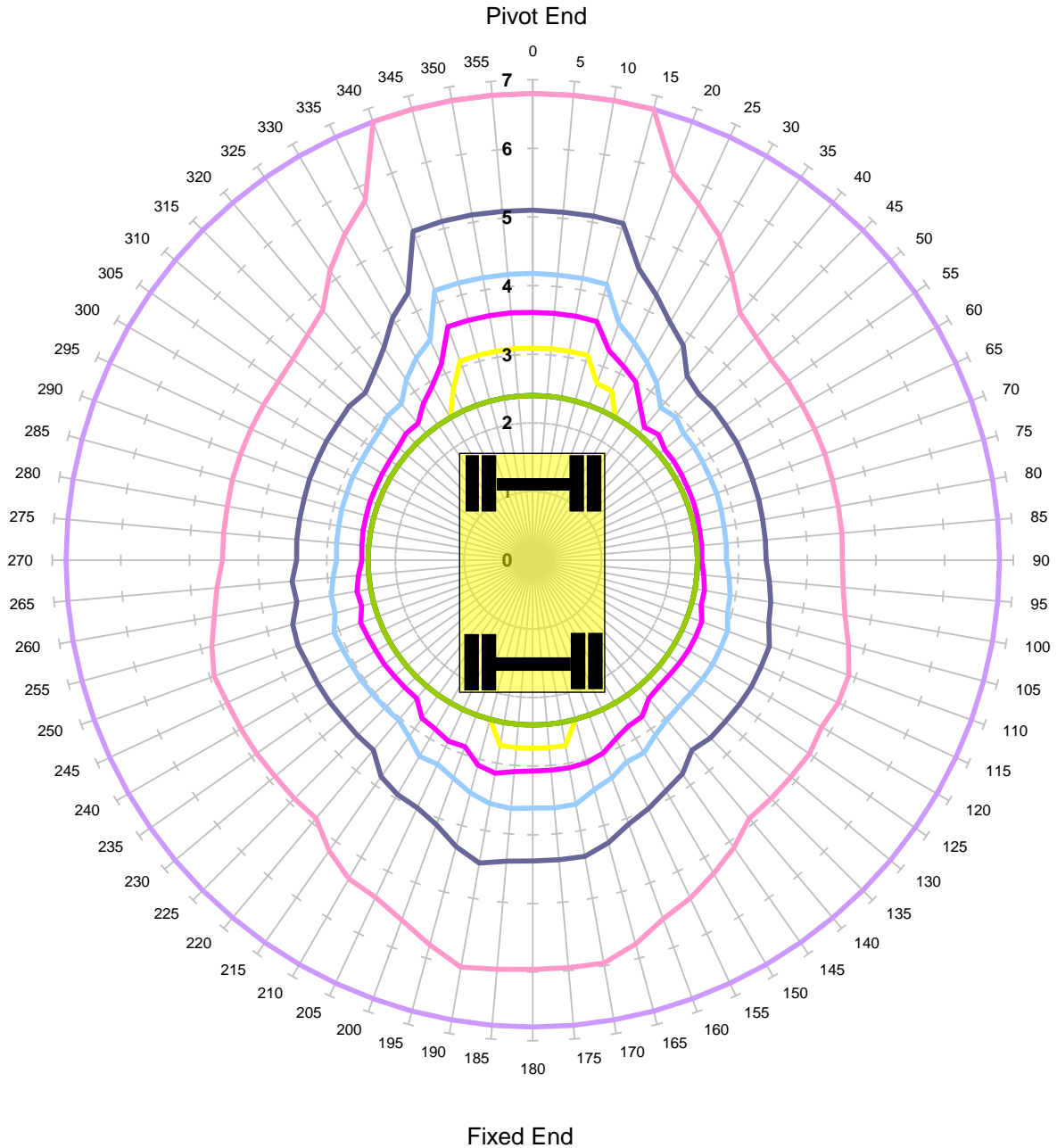

Units in Tonnes

- 1
- 2
- 3
- 4
- 5
- 6
- 7
- 8
- 9
- 10

MACHINE & MODEL:	Volvo EW180	REFERENCE:	
SERIAL No:	8741012	DATE OF CHART:	4-Jun-2021
EQUIPMENT:	2.06m + 3.03m + 2.00m	SAFETY FACTOR:	47.0%
COMMENT:			

Volvo EW180
Max Capacity Contours of Radius(m) Plots 2.0m Dipper
Gradient 1 in -25 Height 2m Lift QH
Unlocked Rail Cant -150mm

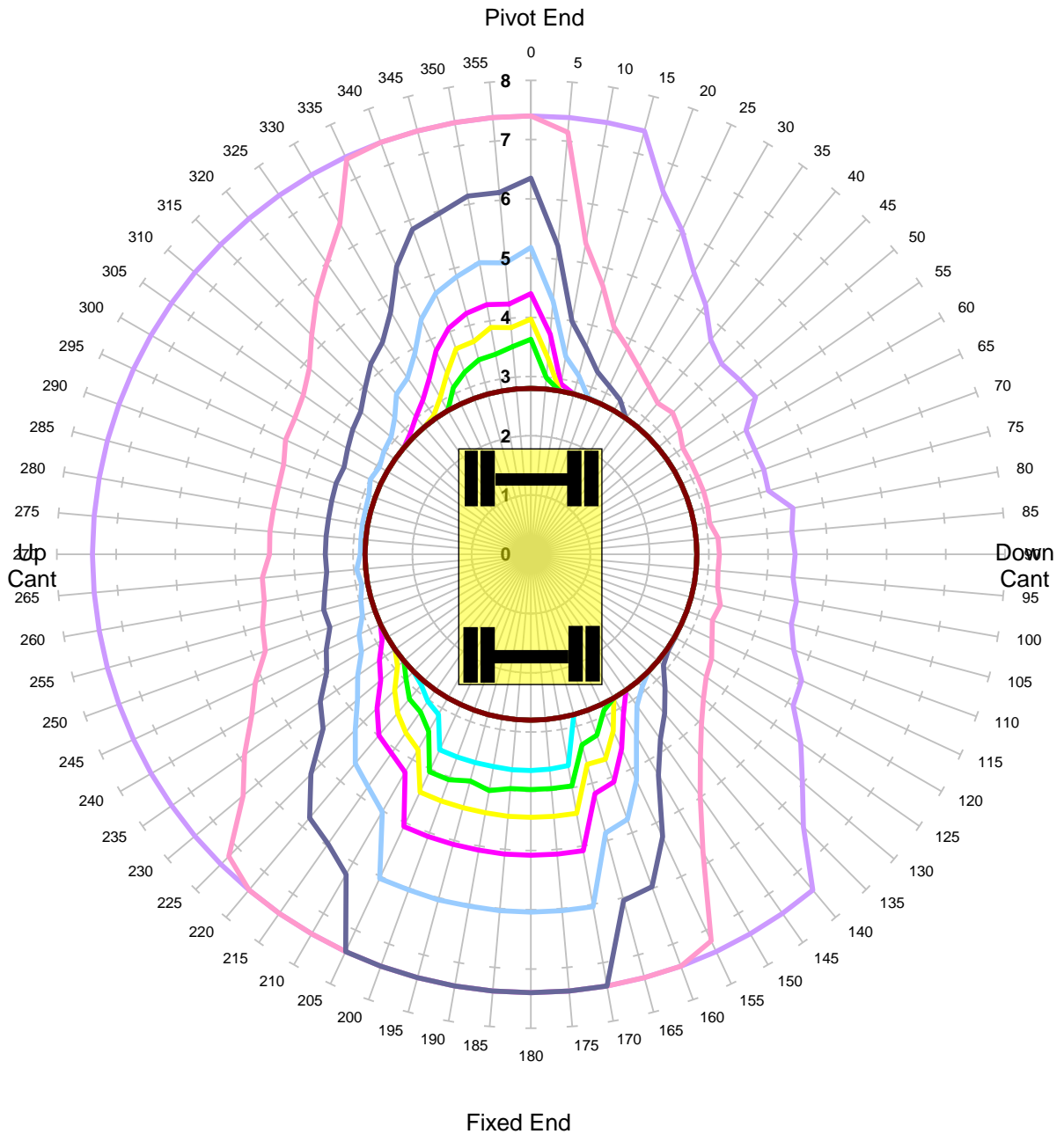

Units in Tonnes

- 1
- 2
- 3
- 4
- 5
- 6
- 7
- 8
- 9
- 10
- 11
- 12
- 13

MACHINE & MODEL:	Volvo EW180	REFERENCE:	
SERIAL No:	8741012	DATE OF CHART:	4-Jun-2021
EQUIPMENT:	2.06m + 3.03m + 2.00m	SAFETY FACTOR:	67.0%
COMMENT:			

Volvo EW180
Max Capacity Contours of Radius(m) Plots 2.0m Dipper
Gradient 1 in -25 Height 2m Lift QH
Unlocked Rail Cant -50mm

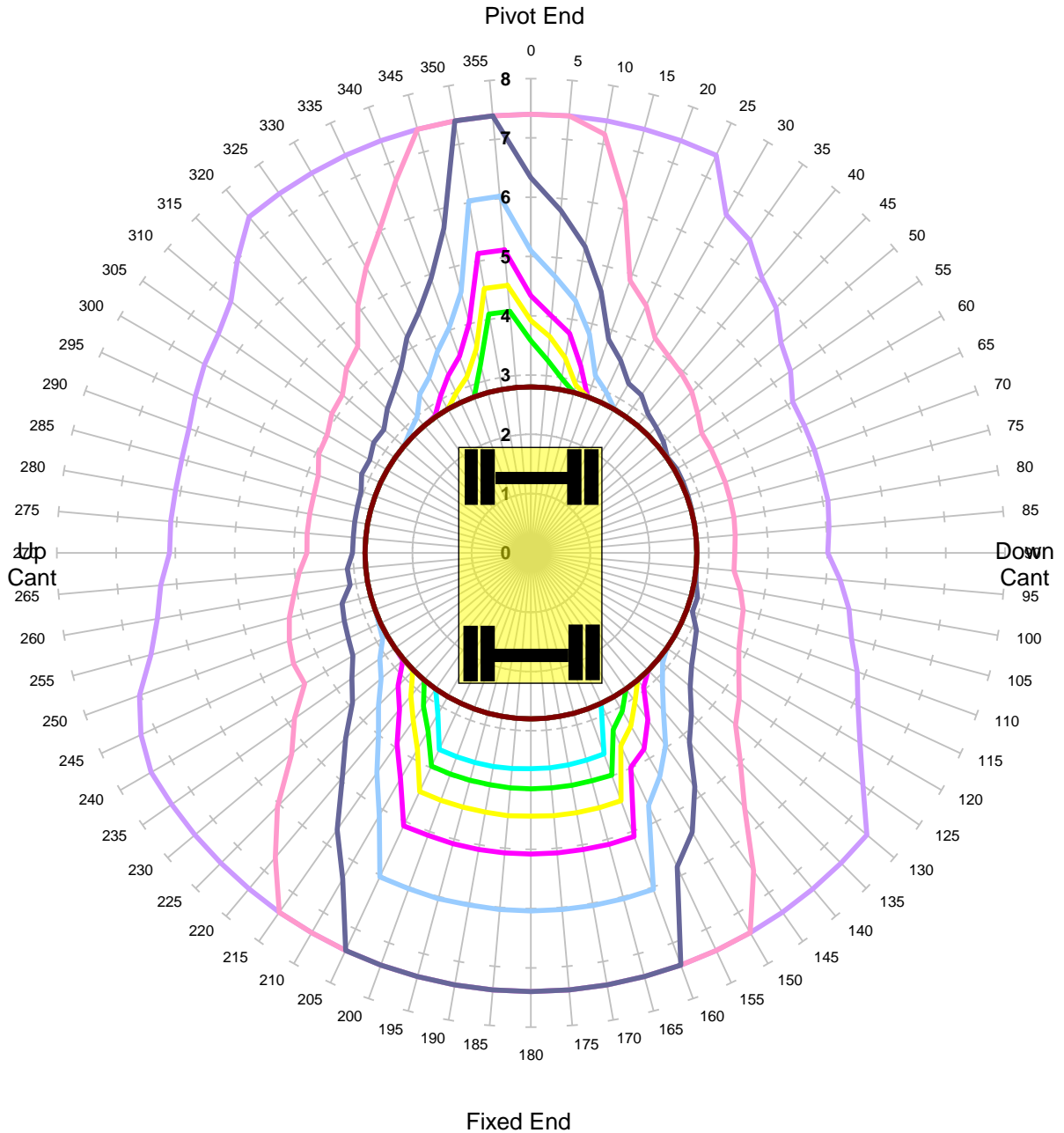

Units in Tonnes

- 1
- 2
- 3
- 4
- 5
- 6
- 7
- 8
- 9
- 10
- 11
- 12
- 13

MACHINE & MODEL:	Volvo EW180	REFERENCE:	
SERIAL No:	8741012	DATE OF CHART:	4-Jun-2021
EQUIPMENT:	2.06m + 3.03m + 2.00m	SAFETY FACTOR:	67.0%
COMMENT:			

Volvo EW180
Max Capacity Contours of Radius(m) Plots 2.0m Dipper
Gradient 1 in -25 Height 2m Lift QH
Unlocked Rail Cant 50mm

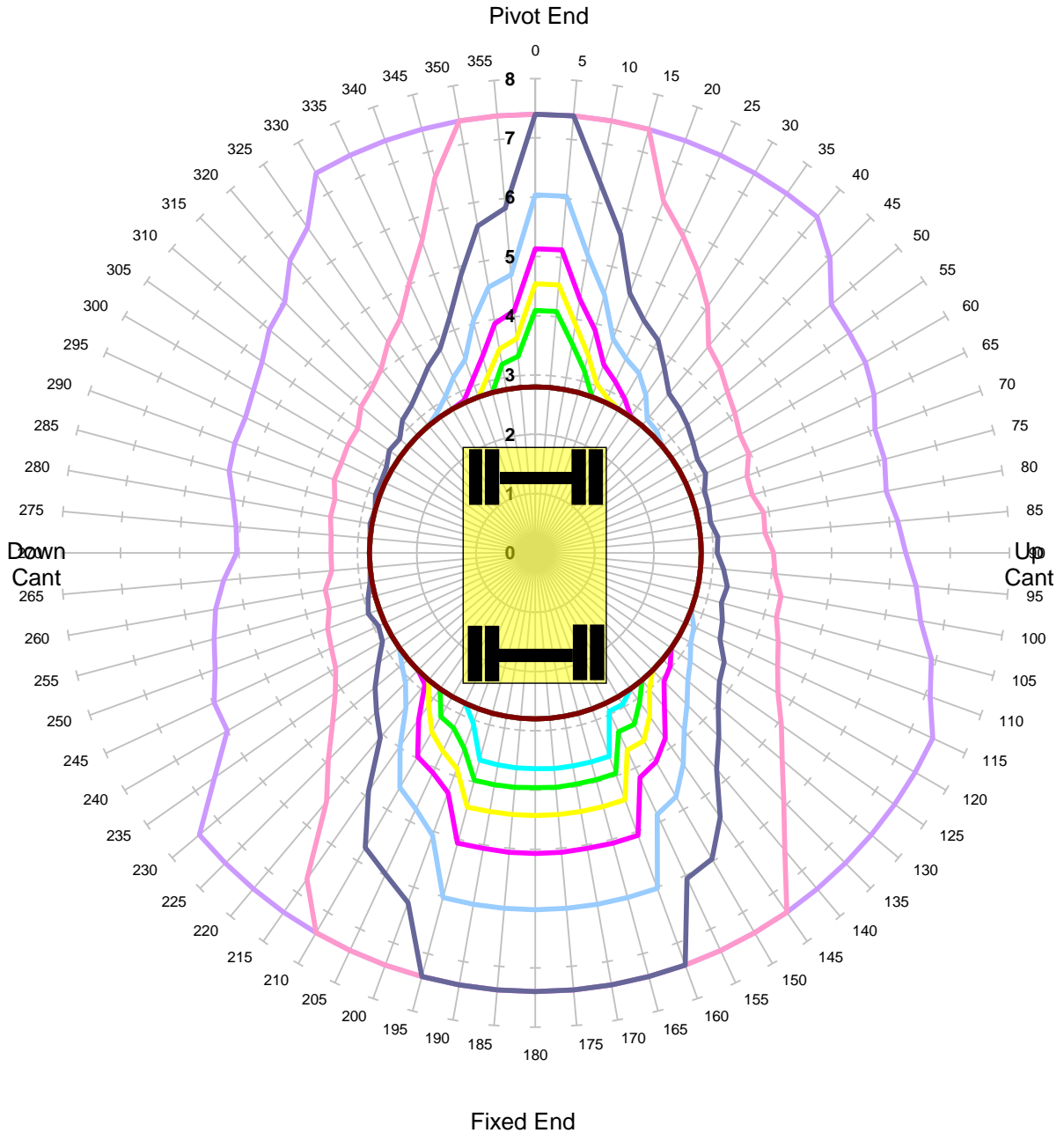

Units in Tonnes

- 1
 — 2
 — 3
 — 4
 — 5
 — 6
 — 7
 — 8
 — 9
 — 10
 — 11
 — 12
 — 13

MACHINE & MODEL:	Volvo EW180	REFERENCE:	
SERIAL No:	8741012	DATE OF CHART:	4-Jun-2021
EQUIPMENT:	2.06m + 3.03m + 2.00m	SAFETY FACTOR:	67.0%
COMMENT:			

Volvo EW180
Max Capacity Contours of Radius(m) Plots 2.0m Dipper
Gradient 1 in -25 Height 2m Lift QH
Unlocked Rail Cant 150mm

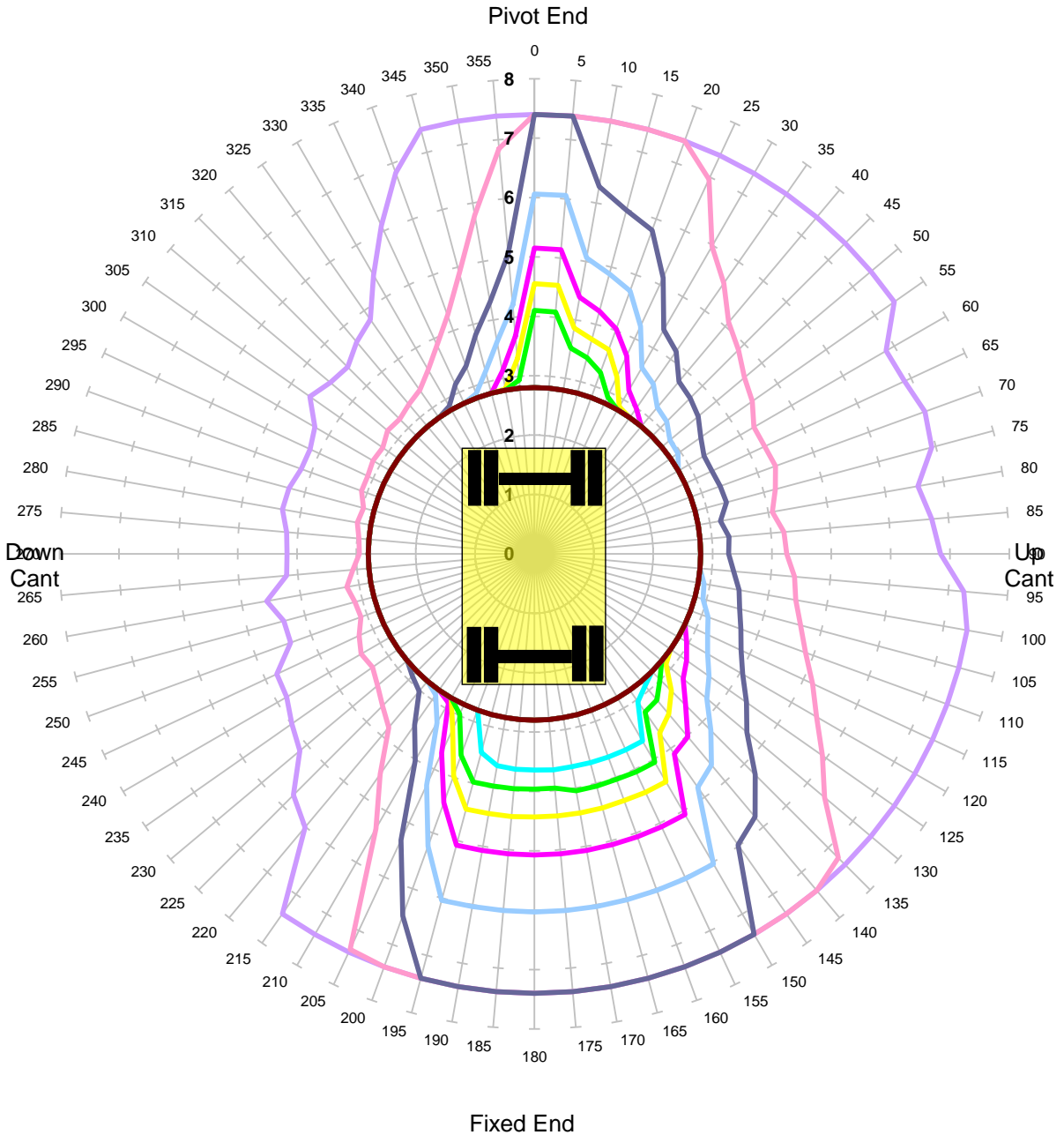

Units in Tonnes

- 1
- 2
- 3
- 4
- 5
- 6
- 7
- 8
- 9
- 10
- 11
- 12
- 13

MACHINE & MODEL:	Volvo EW180	REFERENCE:	
SERIAL No:	8741012	DATE OF CHART:	4-Jun-2021
EQUIPMENT:	2.06m + 3.03m + 2.00m	SAFETY FACTOR:	67.0%
COMMENT:			

Volvo EW180
Max Capacity Contours of Radius(m) Plots 2.0m Dipper
Gradient 1 in -25 Height 2m Lift QH
Locked Rail Cant -150mm

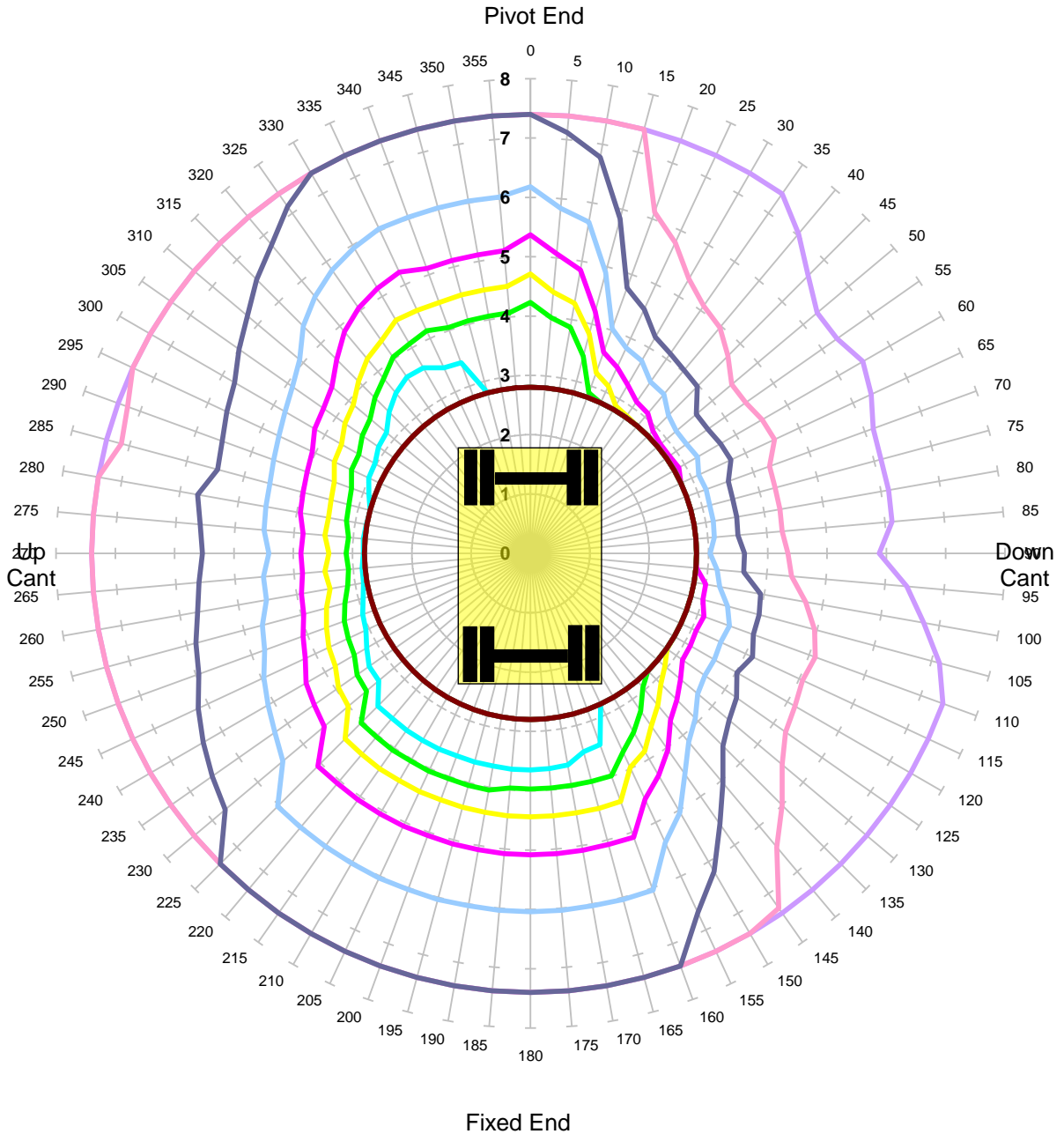

Units in Tonnes

- 1
- 2
- 3
- 4
- 5
- 6
- 7
- 8
- 9
- 10
- 11
- 12
- 13

MACHINE & MODEL:	Volvo EW180	REFERENCE:	
SERIAL No:	8741012	DATE OF CHART:	4-Jun-2021
EQUIPMENT:	2.06m + 3.03m + 2.00m	SAFETY FACTOR:	90.0%
COMMENT:			

Volvo EW180
Max Capacity Contours of Radius(m) Plots 2.0m Dipper
Gradient 1 in -25 Height 2m Lift QH
Locked Rail Cant -50mm

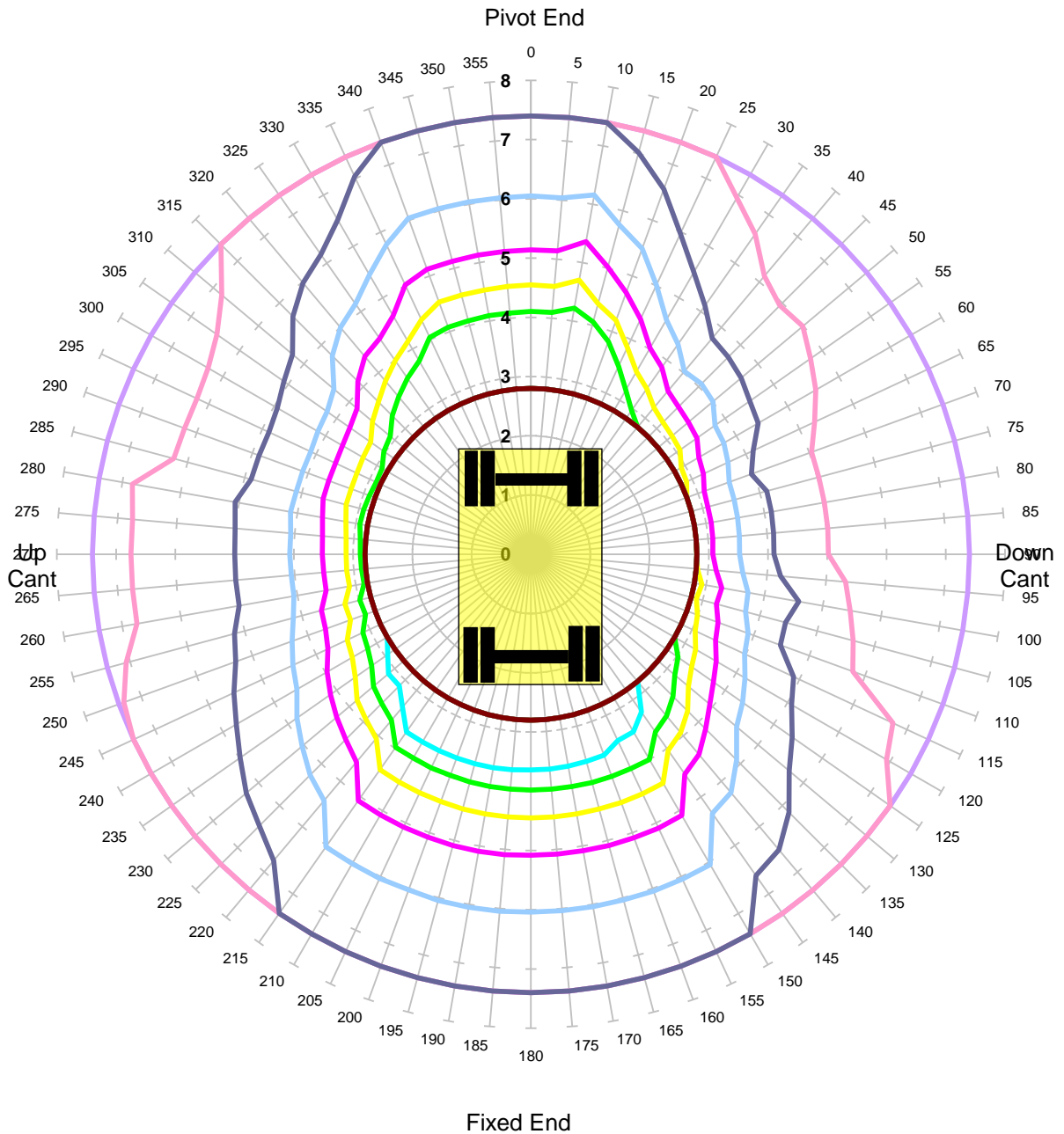

Units in Tonnes

- 1
- 2
- 3
- 4
- 5
- 6
- 7
- 8
- 9
- 10
- 11
- 12
- 13

MACHINE & MODEL:	Volvo EW180	REFERENCE:	
SERIAL No:	8741012	DATE OF CHART:	4-Jun-2021
EQUIPMENT:	2.06m + 3.03m + 2.00m	SAFETY FACTOR:	90.0%
COMMENT:			

Volvo EW180
Max Capacity Contours of Radius(m) Plots 2.0m Dipper
Gradient 1 in -25 Height 2m Lift QH
Locked Rail Cant 50mm

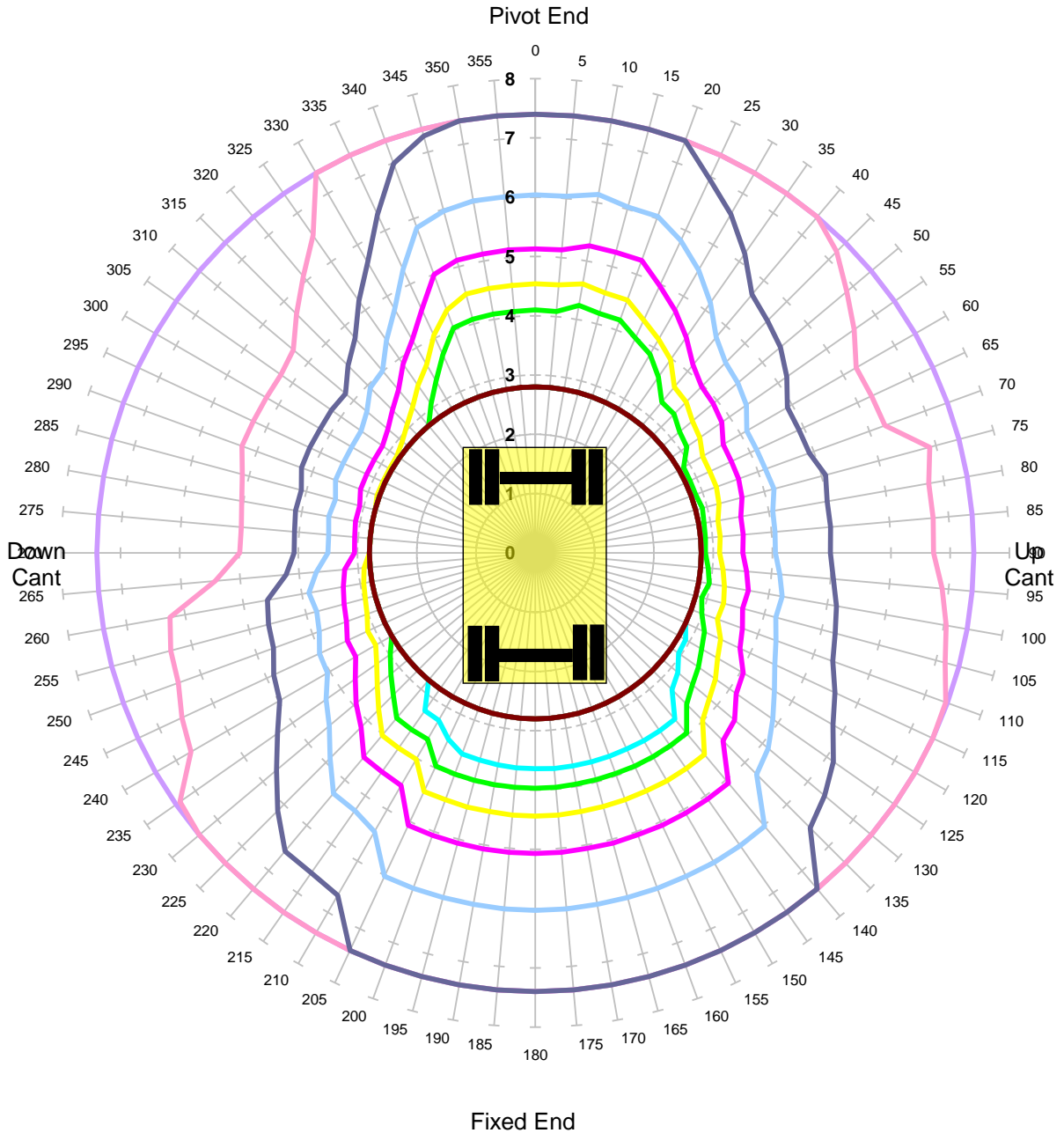

Units in Tonnes

- 1
- 2
- 3
- 4
- 5
- 6
- 7
- 8
- 9
- 10
- 11
- 12
- 13

MACHINE & MODEL:	Volvo EW180	REFERENCE:	
SERIAL No:	8741012	DATE OF CHART:	4-Jun-2021
EQUIPMENT:	2.06m + 3.03m + 2.00m	SAFETY FACTOR:	90.0%
COMMENT:			

Volvo EW180
Max Capacity Contours of Radius(m) Plots 2.0m Dipper
Gradient 1 in -25 Height 2m Lift QH
Locked Rail Cant 150mm

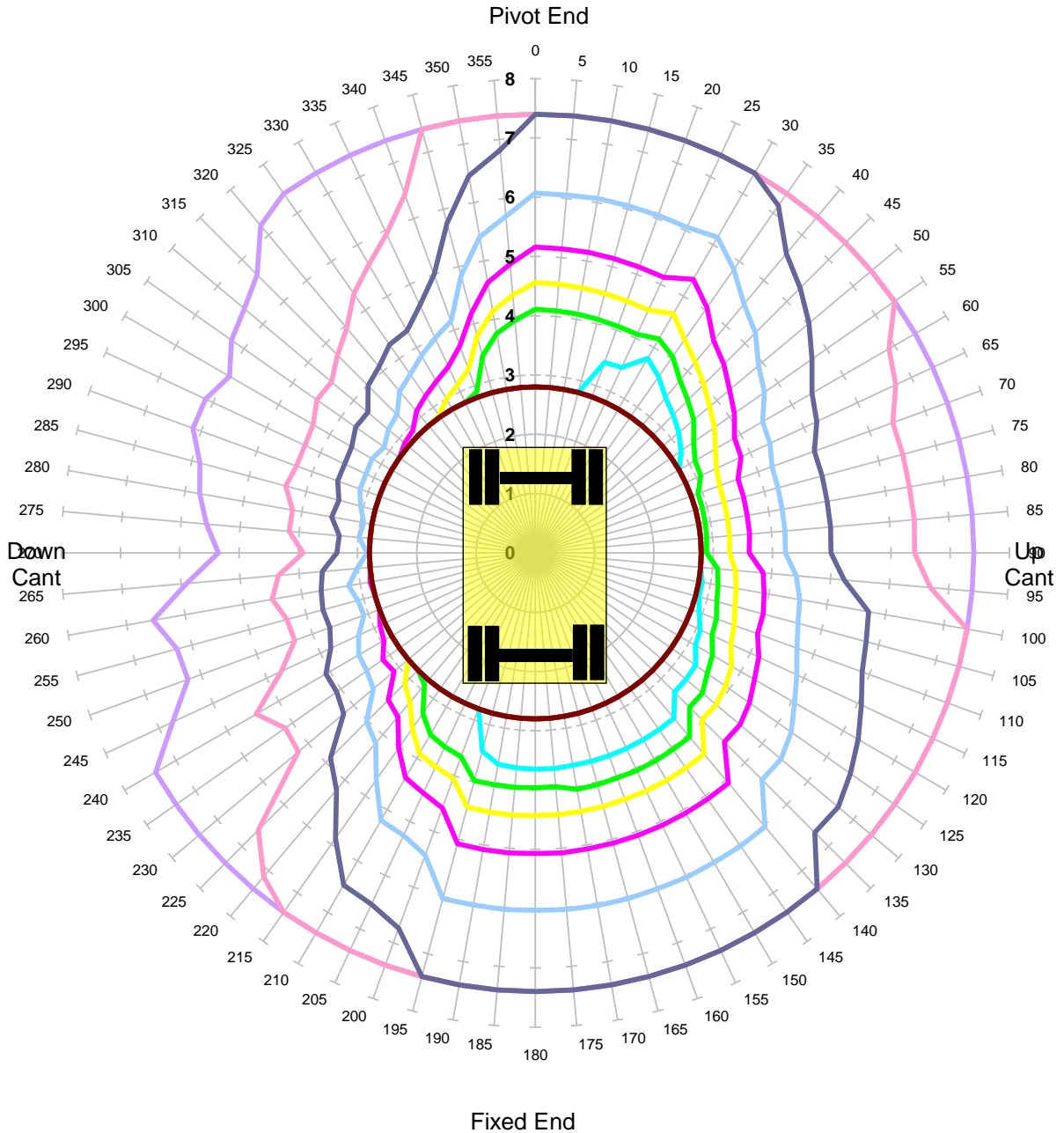

Units in Tonnes

- 1
- 2
- 3
- 4
- 5
- 6
- 7
- 8
- 9
- 10
- 11
- 12
- 13

MACHINE & MODEL:	Volvo EW180	REFERENCE:	
SERIAL No:	8741012	DATE OF CHART:	4-Jun-2021
EQUIPMENT:	2.06m + 3.03m + 2.00m	SAFETY FACTOR:	90.0%
COMMENT:			

Volvo EW180
Max Capacity Contours of Radius(m) Plots 2.0m Dipper
Level Ground Height 2m Lift QH
Unlocked Road

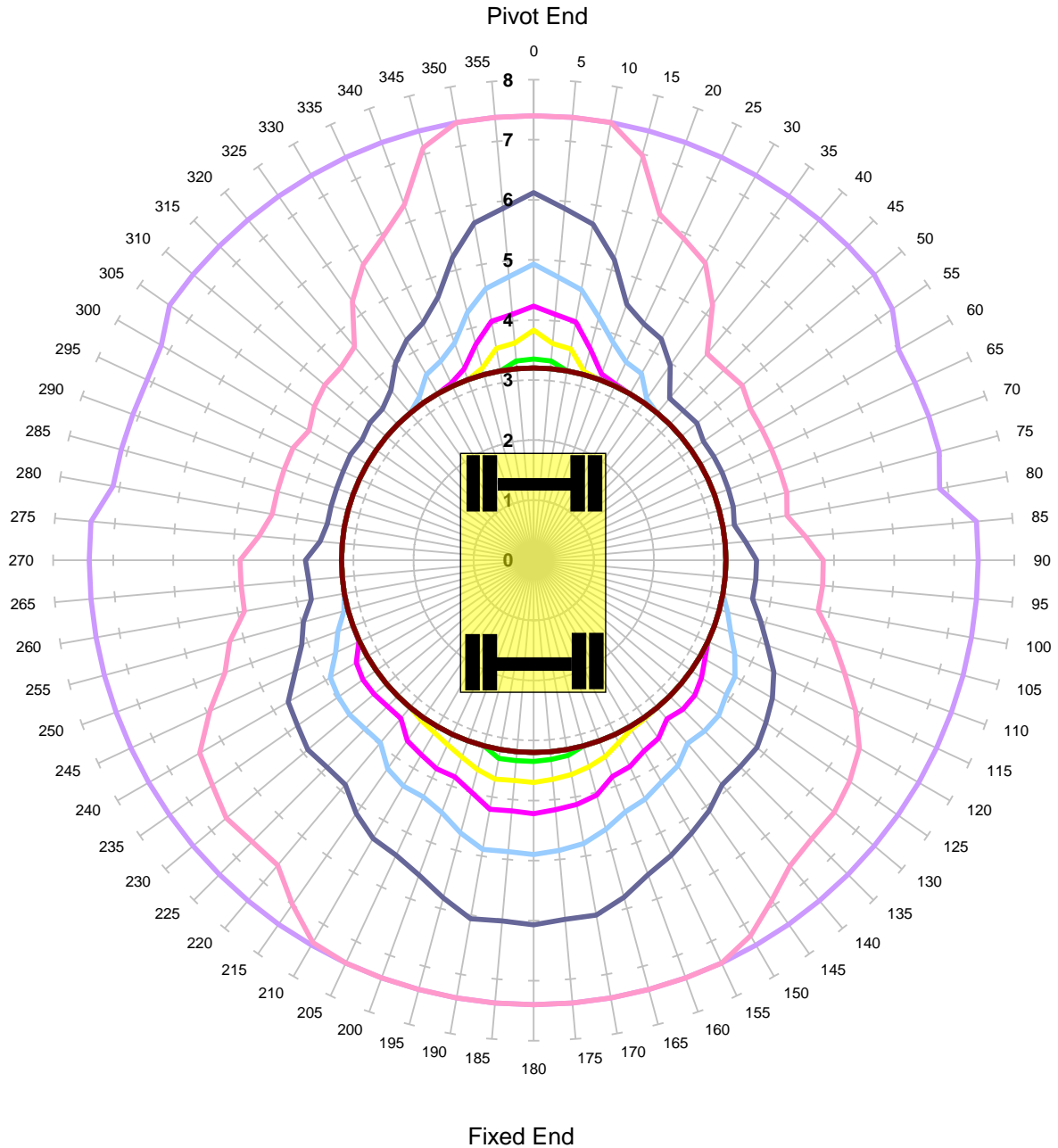

Units in Tonnes

- 1
 — 2
 — 3
 — 4
 — 5
 — 6
 — 7
 — 8
 — 9
 — 10
 — 11
 — 12
 — 13

MACHINE & MODEL:	Volvo EW180	REFERENCE:	
SERIAL No:	8741012	DATE OF CHART:	4-Jun-2021
EQUIPMENT:	2.06m + 3.03m + 2.00m	SAFETY FACTOR:	71.0%
COMMENT:			

Volvo EW180
Max Capacity Contours of Radius(m) Plots 2.0m Dipper
Level Ground Height 2m Lift QH
Locked Road

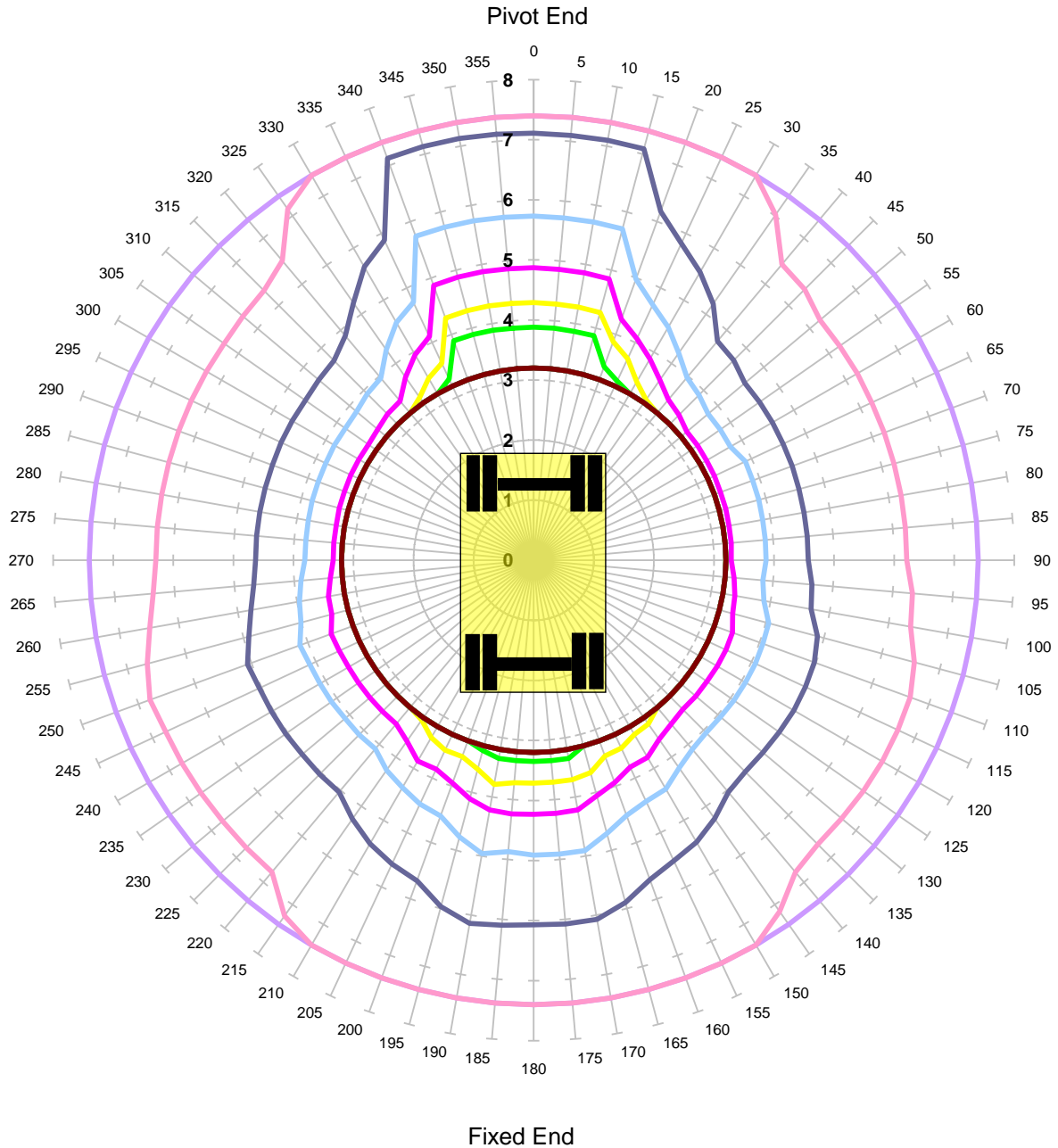

Units in Tonnes

- 1
 — 2
 — 3
 — 4
 — 5
 — 6
 — 7
 — 8
 — 9
 — 10
 — 11
 — 12
 — 13

MACHINE & MODEL:	Volvo EW180	REFERENCE:	
SERIAL No:	8741012	DATE OF CHART:	4-Jun-2021
EQUIPMENT:	2.06m + 3.03m + 2.00m	SAFETY FACTOR:	71.0%
COMMENT:			

Volvo EW180
Max Capacity Contours of Radius(m) Plots 2.0m Dipper
Gradient 1 in -25 Height 2m Lift QH
Unlocked Rail Cant -150mm - Tandem Lift

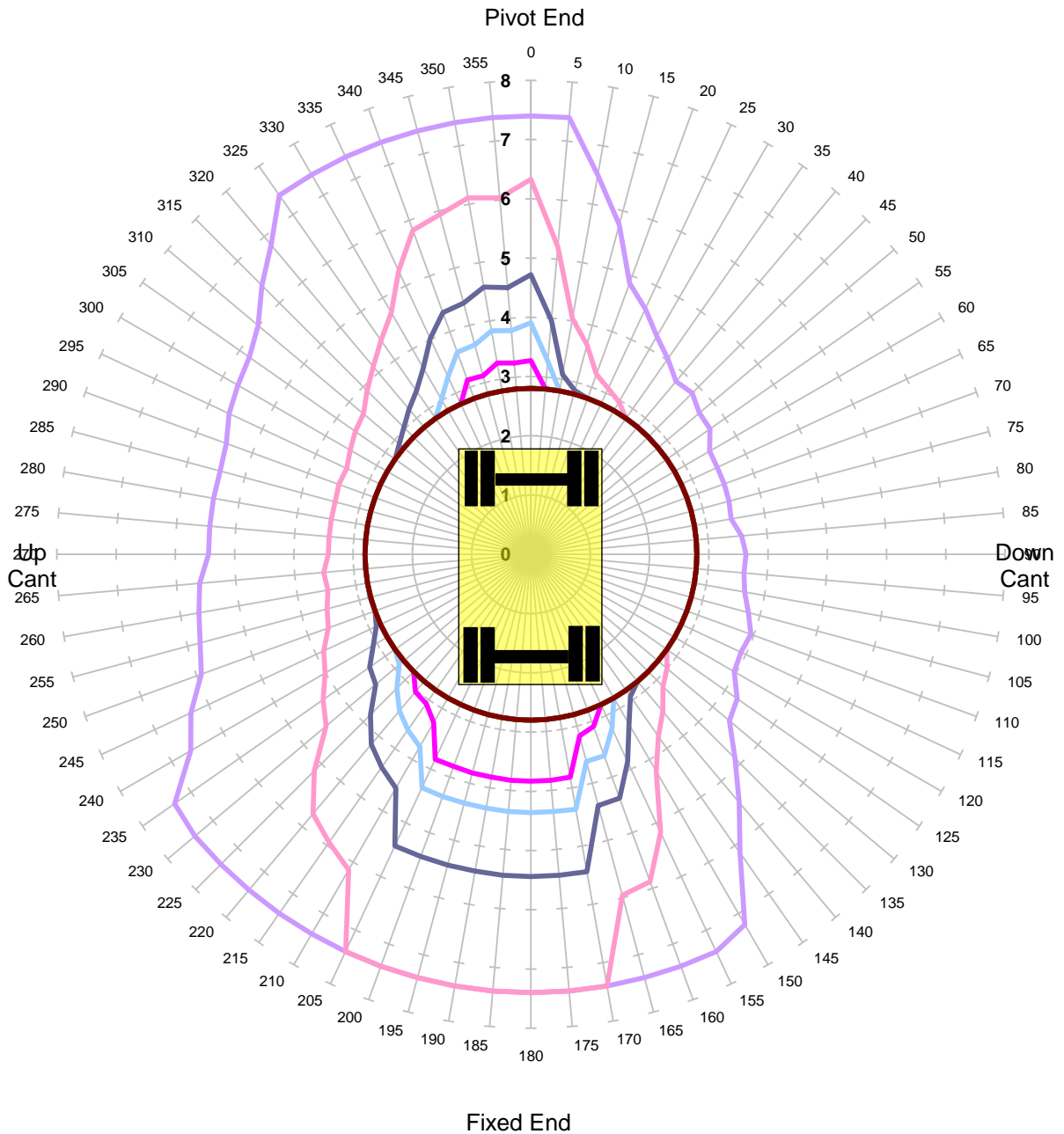

Units in Tonnes

- 1
- 2
- 3
- 4
- 5
- 6
- 7
- 8
- 9
- 10
- 11
- 12
- 13

MACHINE & MODEL:	Volvo EW180	REFERENCE:	
SERIAL No:	8741012	DATE OF CHART:	4-Jun-2021
EQUIPMENT:	2.06m + 3.03m + 2.00m	SAFETY FACTOR:	44.0%
COMMENT:			

Volvo EW180
Max Capacity Contours of Radius(m) Plots 2.0m Dipper
Gradient 1 in -25 Height 2m Lift QH
Unlocked Rail Cant -50mm - Tandem Lift

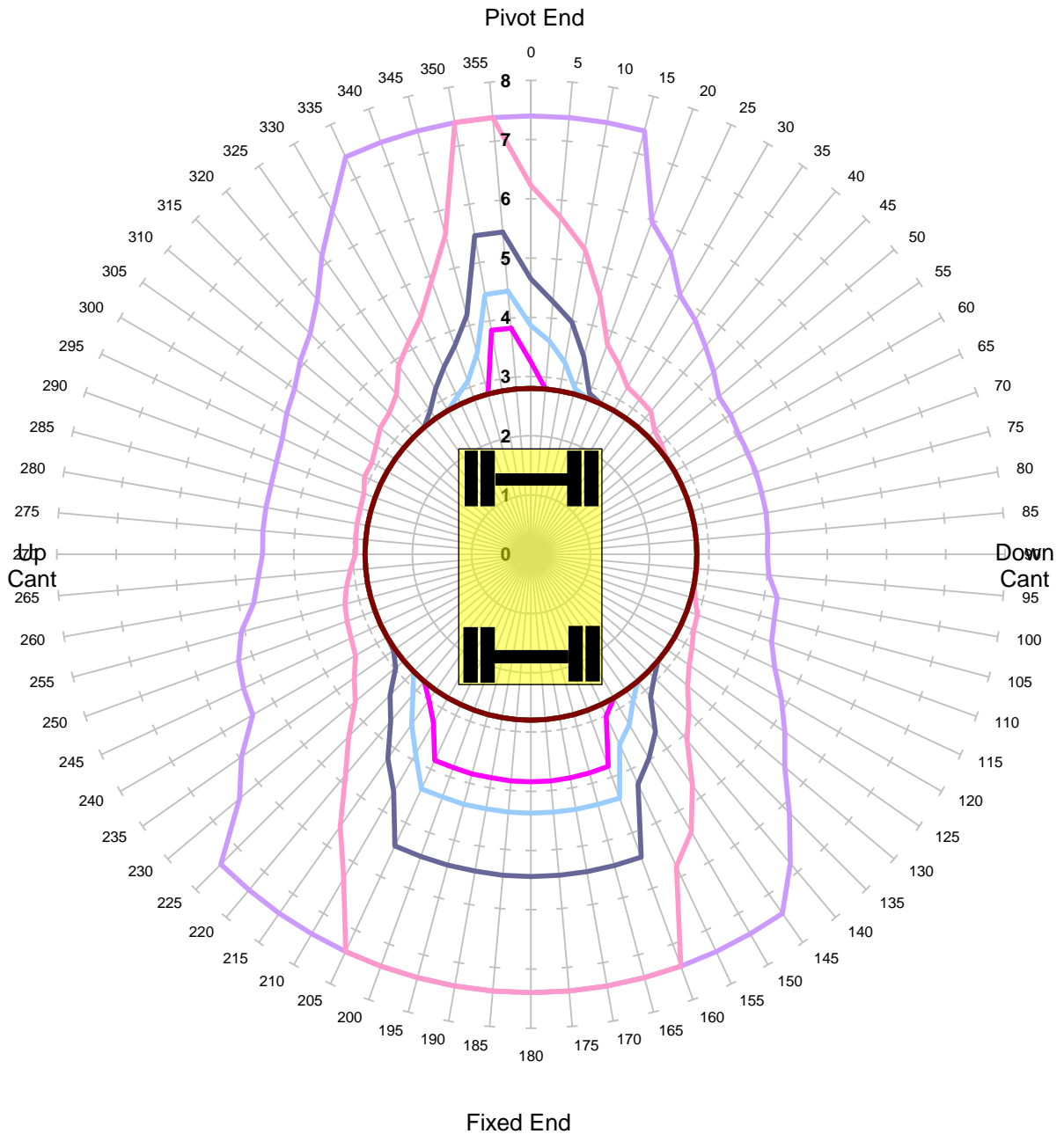

Units in Tonnes

- 1
- 2
- 3
- 4
- 5
- 6
- 7
- 8
- 9
- 10
- 11
- 12
- 13

MACHINE & MODEL:	Volvo EW180	REFERENCE:	
SERIAL No:	8741012	DATE OF CHART:	4-Jun-2021
EQUIPMENT:	2.06m + 3.03m + 2.00m	SAFETY FACTOR:	44.0%
COMMENT:			

Volvo EW180
Max Capacity Contours of Radius(m) Plots 2.0m Dipper
Gradient 1 in -25 Height 2m Lift QH
Unlocked Rail Cant 50mm - Tandem Lift

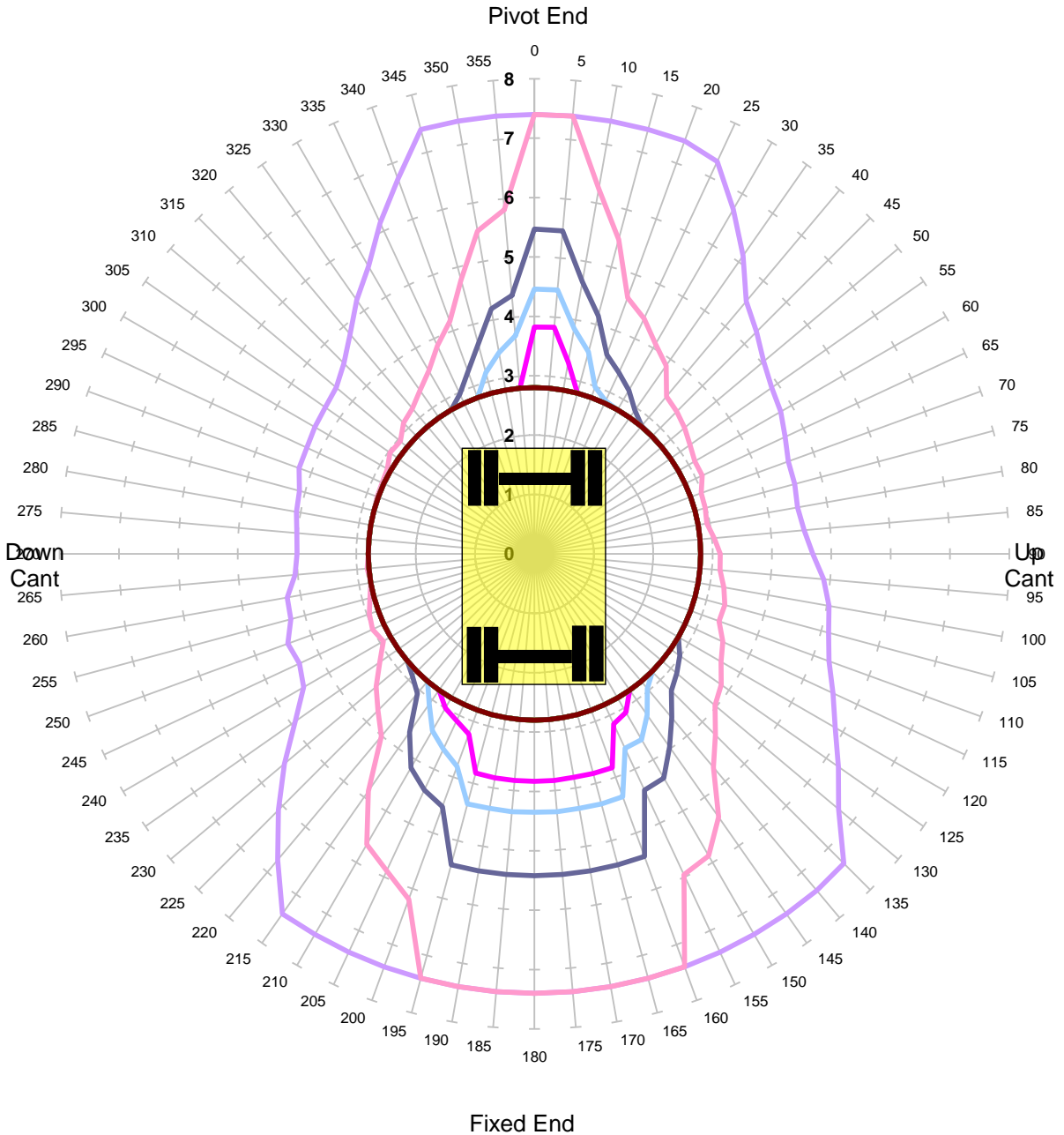

Units in Tonnes

- 1
- 2
- 3
- 4
- 5
- 6
- 7
- 8
- 9
- 10
- 11
- 12
- 13

MACHINE & MODEL:	Volvo EW180	REFERENCE:	
SERIAL No:	8741012	DATE OF CHART:	4-Jun-2021
EQUIPMENT:	2.06m + 3.03m + 2.00m	SAFETY FACTOR:	44.0%
COMMENT:			

Volvo EW180
Max Capacity Contours of Radius(m) Plots 2.0m Dipper
Gradient 1 in -25 Height 2m Lift QH
Unlocked Rail Cant 150mm - Tandem Lift

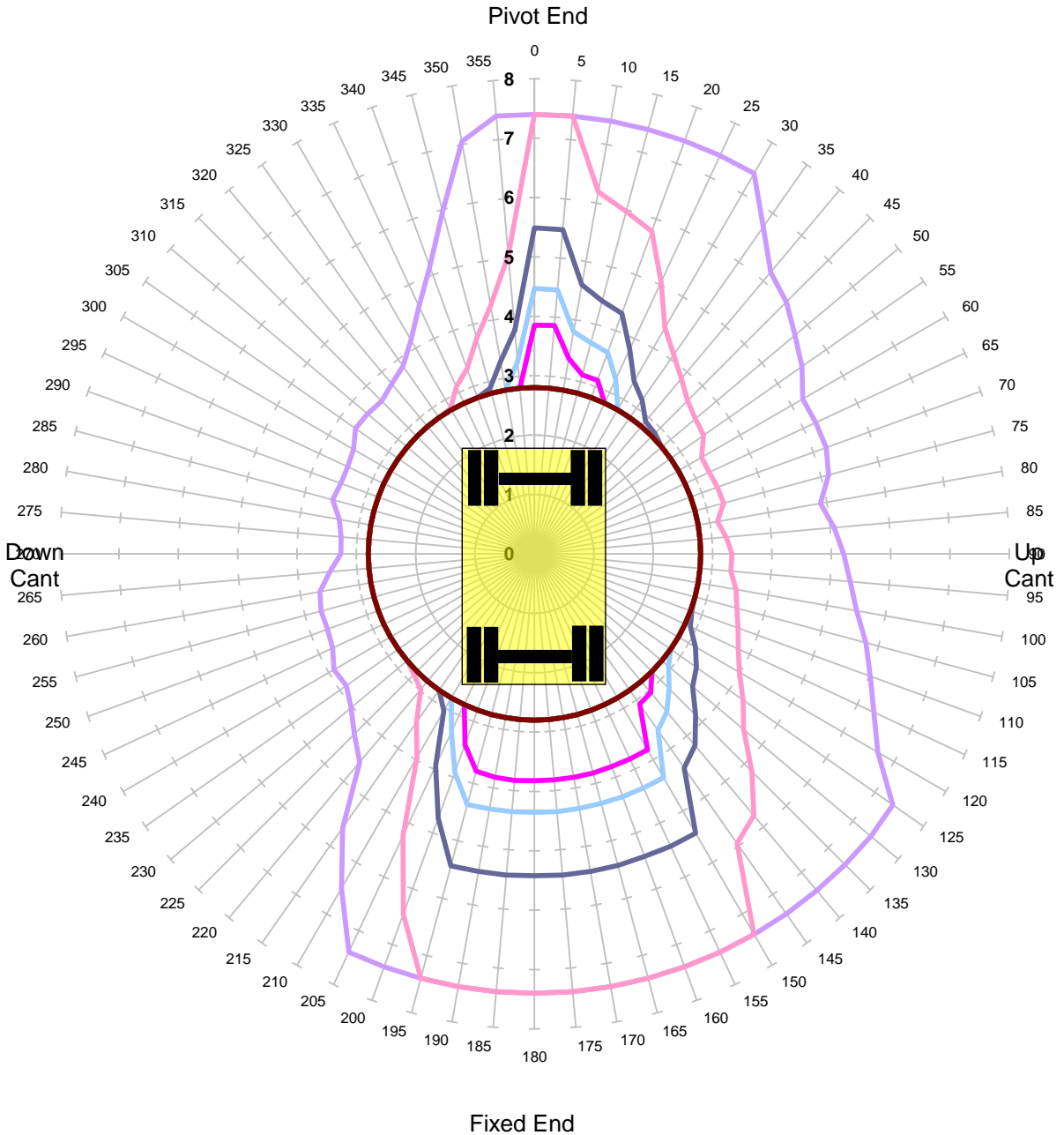

Units in Tonnes

- 1
- 2
- 3
- 4
- 5
- 6
- 7
- 8
- 9
- 10
- 11
- 12
- 13

MACHINE & MODEL:	Volvo EW180	REFERENCE:	
SERIAL No:	8741012	DATE OF CHART:	4-Jun-2021
EQUIPMENT:	2.06m + 3.03m + 2.00m	SAFETY FACTOR:	44.0%
COMMENT:			

Volvo EW180
Max Capacity Contours of Radius(m) Plots 2.0m Dipper
Gradient 1 in -25 Height 2m Lift QH
Locked Rail Cant -150mm - Tandem Lift

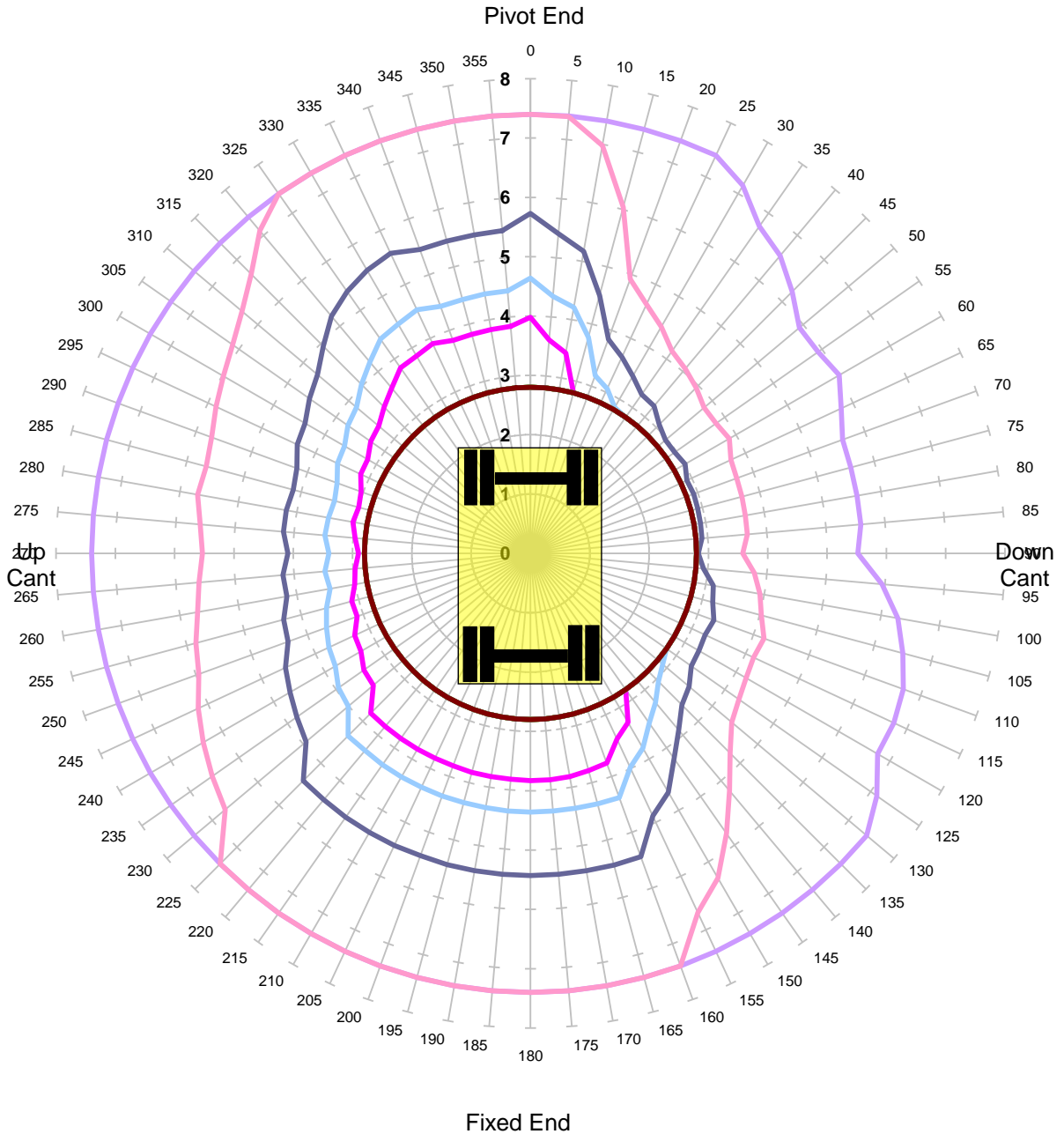

Units in Tonnes

- 1
- 2
- 3
- 4
- 5
- 6
- 7
- 8
- 9
- 10
- 11
- 12
- 13

MACHINE & MODEL:	Volvo EW180	REFERENCE:	
SERIAL No:	8741012	DATE OF CHART:	4-Jun-2021
EQUIPMENT:	2.06m + 3.03m + 2.00m	SAFETY FACTOR:	59.0%
COMMENT:			

Volvo EW180
Max Capacity Contours of Radius(m) Plots 2.0m Dipper
Gradient 1 in -25 Height 2m Lift QH
Locked Rail Cant -50mm - Tandem Lift

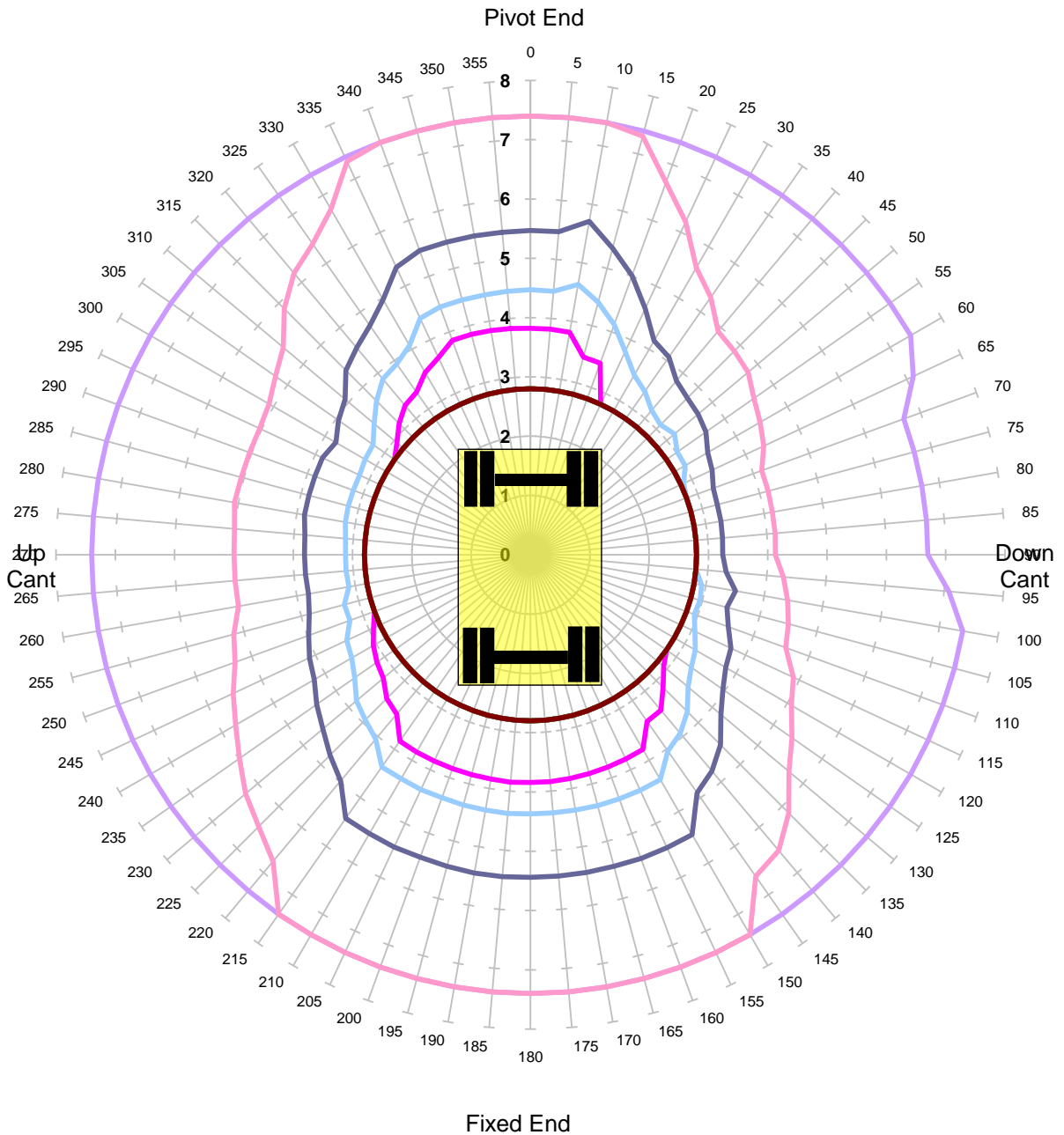

Units in Tonnes

- 1
- 2
- 3
- 4
- 5
- 6
- 7
- 8
- 9
- 10
- 11
- 12
- 13

MACHINE & MODEL:	Volvo EW180	REFERENCE:	
SERIAL No:	8741012	DATE OF CHART:	4-Jun-2021
EQUIPMENT:	2.06m + 3.03m + 2.00m	SAFETY FACTOR:	59.0%
COMMENT:			

Volvo EW180
Max Capacity Contours of Radius(m) Plots 2.0m Dipper
Gradient 1 in -25 Height 2m Lift QH
Locked Rail Cant 50mm - Tandem Lift

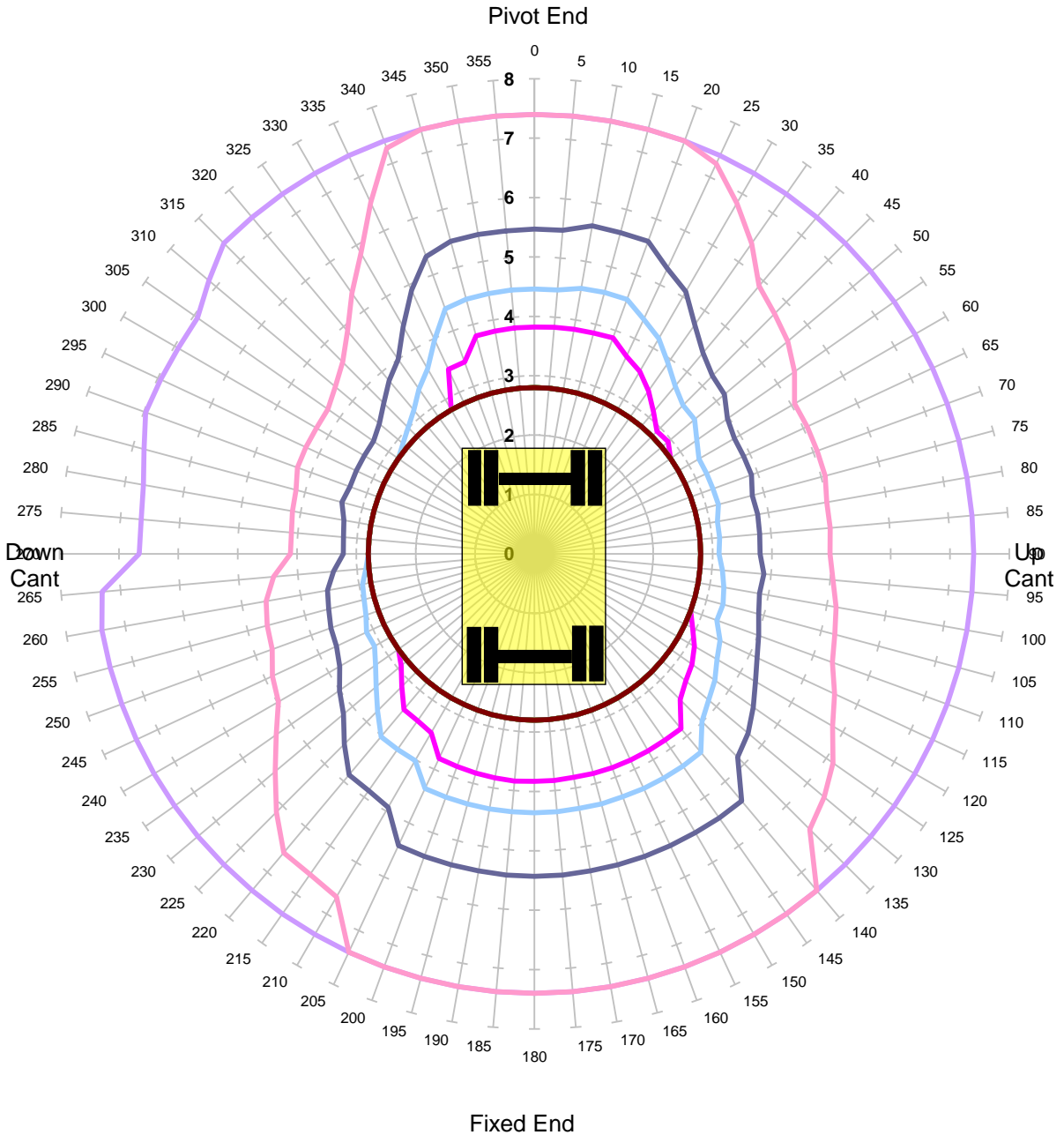

Units in Tonnes

- 1
- 2
- 3
- 4
- 5
- 6
- 7
- 8
- 9
- 10
- 11
- 12
- 13

MACHINE & MODEL:	Volvo EW180	REFERENCE:	
SERIAL No:	8741012	DATE OF CHART:	4-Jun-2021
EQUIPMENT:	2.06m + 3.03m + 2.00m	SAFETY FACTOR:	59.0%
COMMENT:			

Volvo EW180
Max Capacity Contours of Radius(m) Plots 2.0m Dipper
Gradient 1 in -25 Height 2m Lift QH
Locked Rail Cant 150mm - Tandem Lift

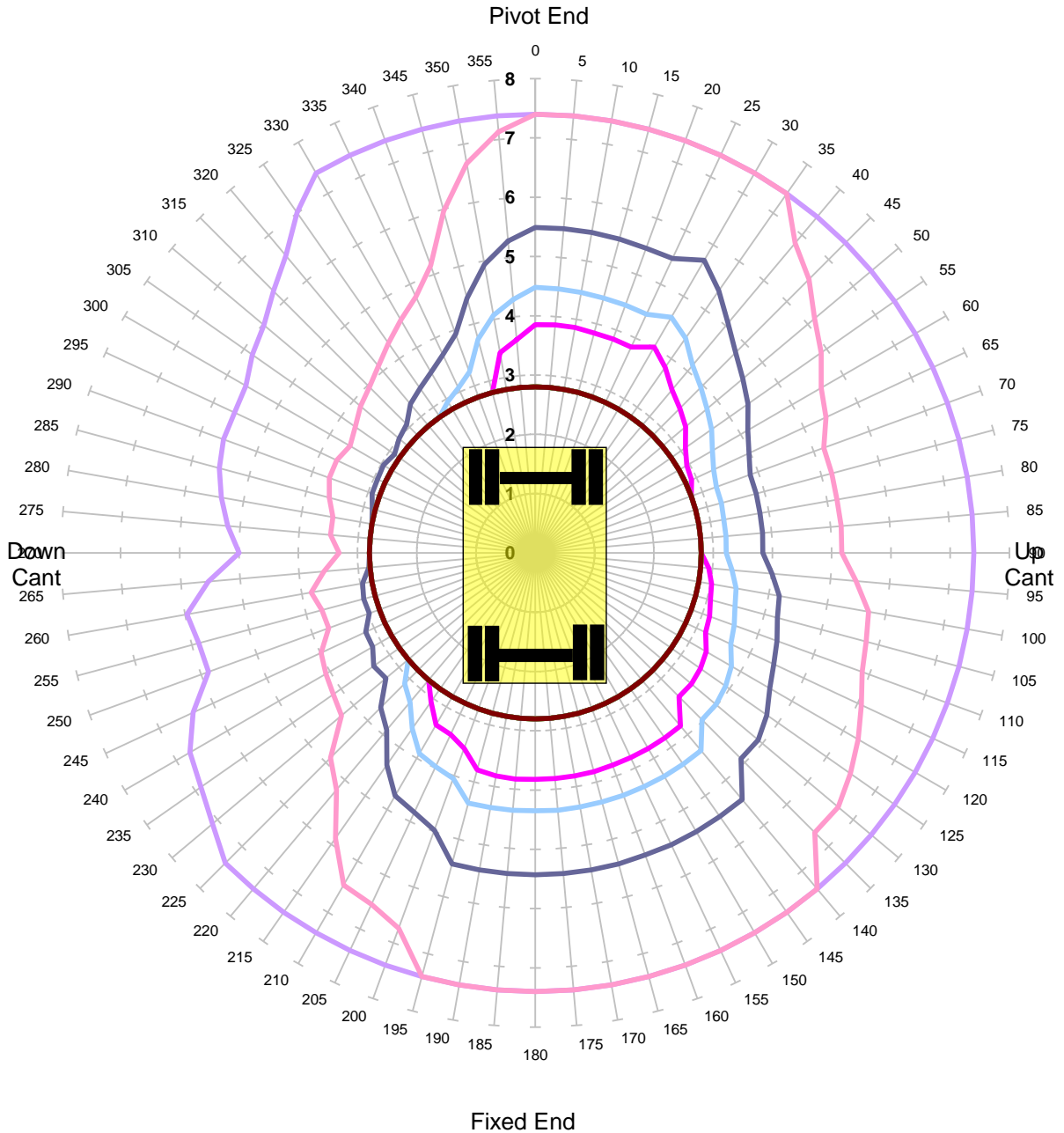

Units in Tonnes

- 1
 — 2
 — 3
 — 4
 — 5
 — 6
 — 7
 — 8
 — 9
 — 10
 — 11
 — 12
 — 13

MACHINE & MODEL:	Volvo EW180	REFERENCE:	
SERIAL No:	8741012	DATE OF CHART:	4-Jun-2021
EQUIPMENT:	2.06m + 3.03m + 2.00m	SAFETY FACTOR:	59.0%
COMMENT:			

Volvo EW180
Max Capacity Contours of Radius(m) Plots 2.0m Dipper
Level Ground Height 2m Lift QH
Unlocked Road - Tandem Lift

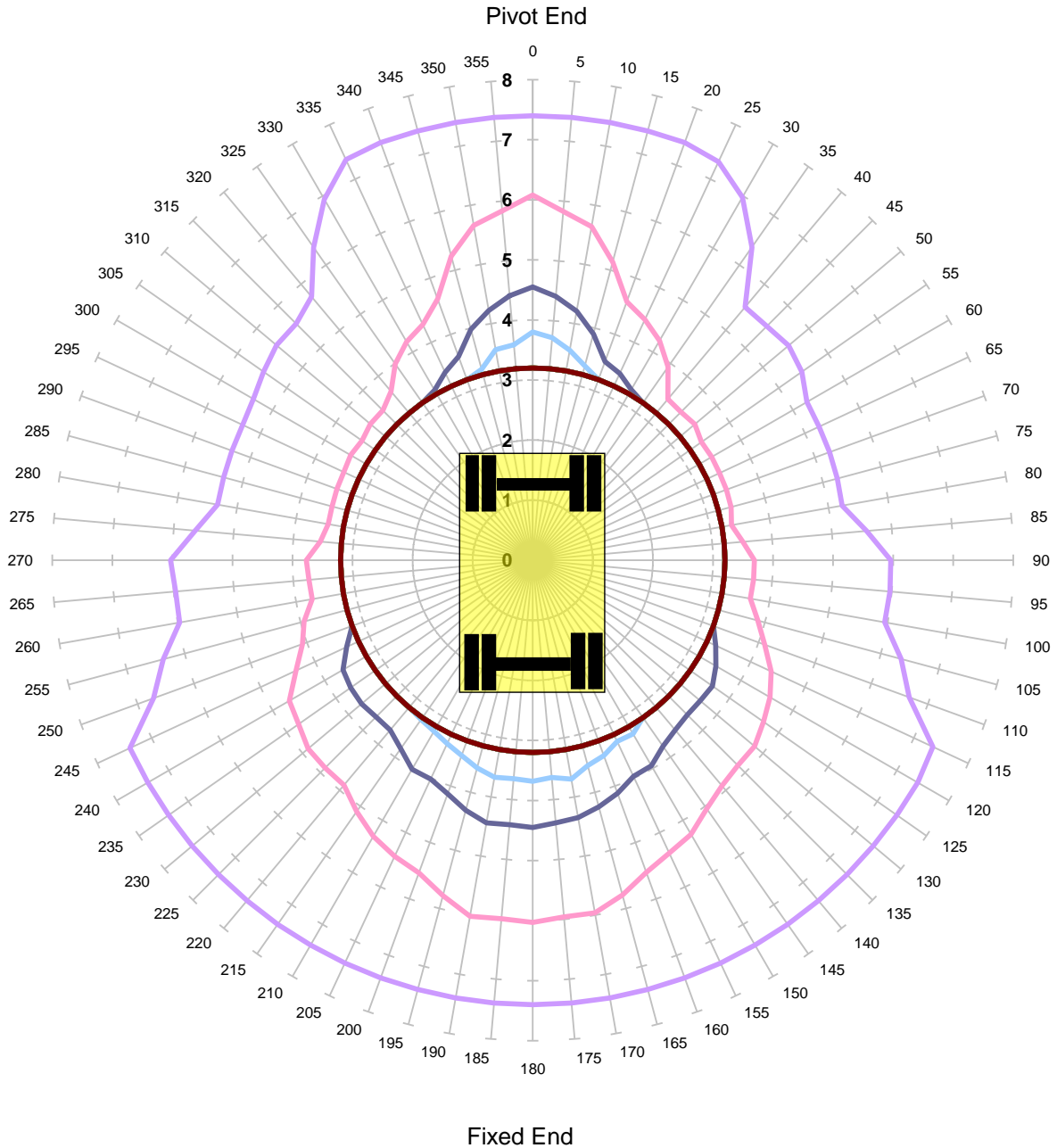

Units in Tonnes

- 1
 — 2
 — 3
 — 4
 — 5
 — 6
 — 7
 — 8
 — 9
 — 10
 — 11
 — 12
 — 13

MACHINE & MODEL:	Volvo EW180	REFERENCE:	
SERIAL No:	8741012	DATE OF CHART:	4-Jun-2021
EQUIPMENT:	2.06m + 3.03m + 2.00m	SAFETY FACTOR:	47.0%
COMMENT:			

Volvo EW180
Max Capacity Contours of Radius(m) Plots 2.0m Dipper
Level Ground Height 2m Lift QH
Locked Road - Tandem Lift

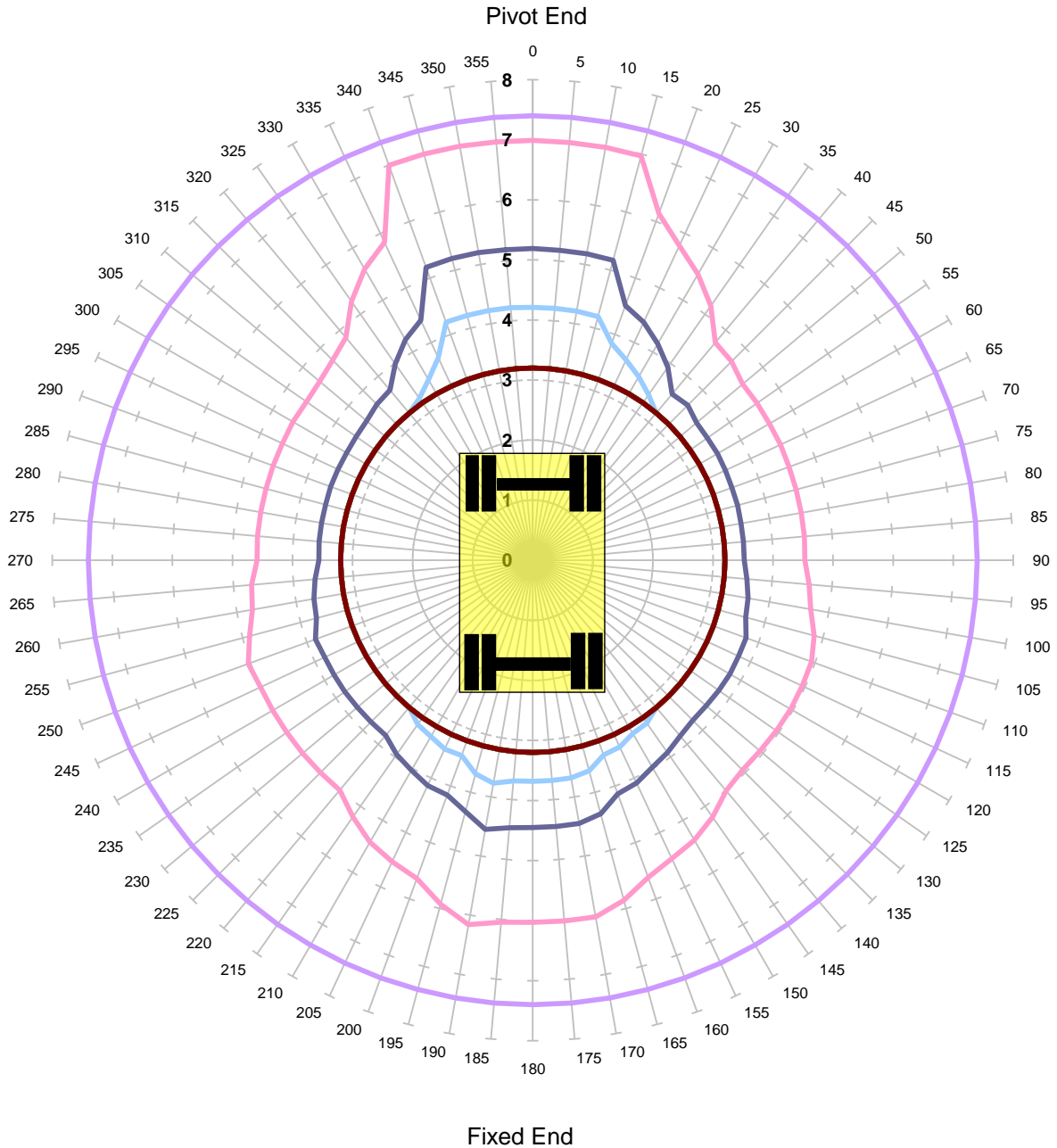

Units in Tonnes

- 1
 — 2
 — 3
 — 4
 — 5
 — 6
 — 7
 — 8
 — 9
 — 10
 — 11
 — 12
 — 13

MACHINE & MODEL:	Volvo EW180	REFERENCE:	
SERIAL No:	8741012	DATE OF CHART:	4-Jun-2021
EQUIPMENT:	2.06m + 3.03m + 2.00m	SAFETY FACTOR:	47.0%
COMMENT:			