

**Komatsu PW160-7**  
**Max Capacity Contours of Radius(m) Plots 2.1m Dipper**  
**Gradient 1 in -25 Height 2m Lift BP**  
**Unlocked Rail Cant -150mm**

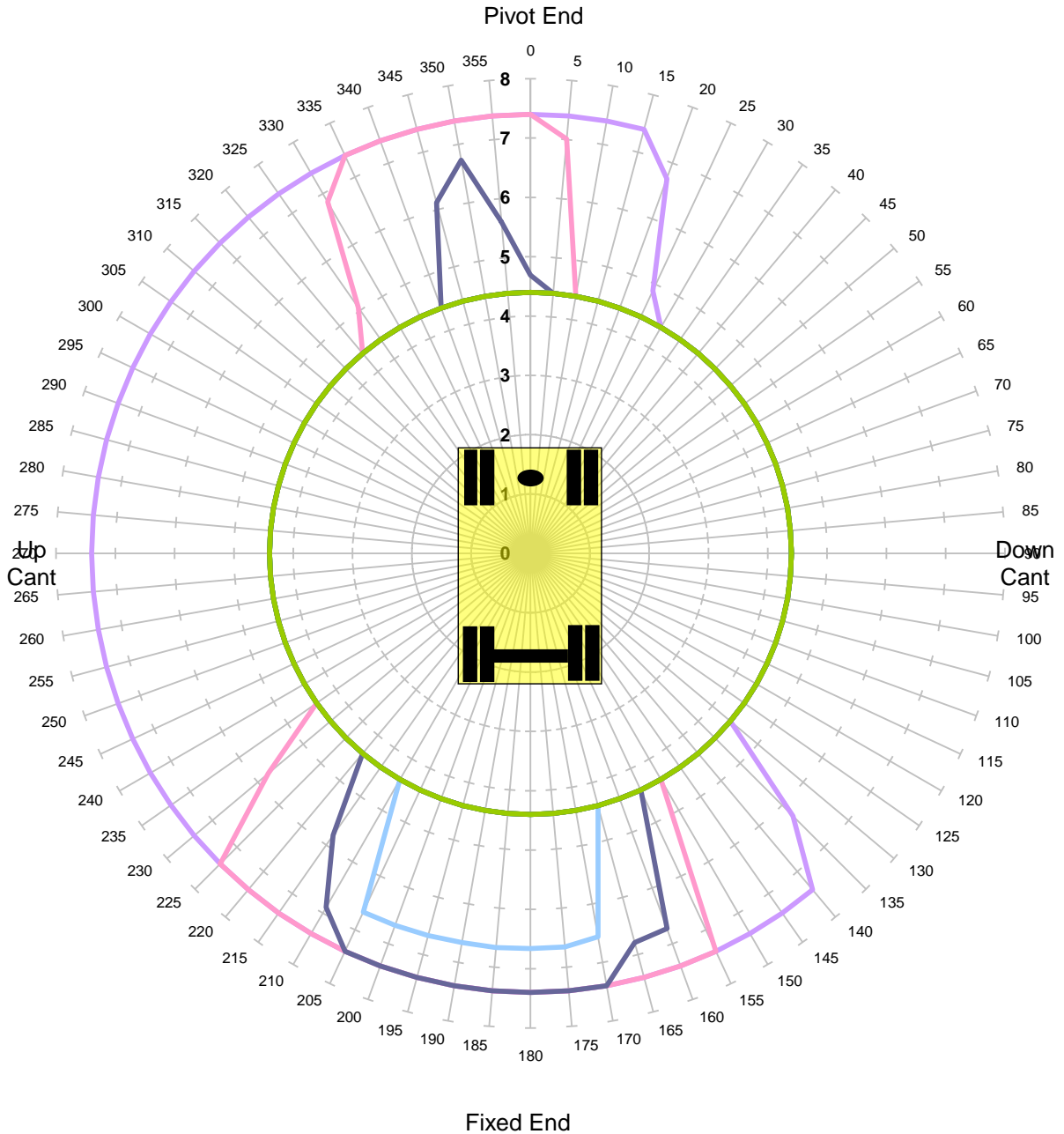

Units in Tonnes

- 1
- 2
- 3
- 4
- 5
- 6
- 7
- 8
- 9
- 10

<b>MACHINE &amp; MODEL:</b>	Komatsu PW160-7	<b>REFERENCE:</b>	
<b>SERIAL No:</b>	H50093	<b>DATE OF CHART:</b>	19-Oct-2021
<b>EQUIPMENT:</b>	5.15m + 2.10m	<b>SAFETY FACTOR:</b>	67.0%
<b>COMMENT:</b>			

**Komatsu PW160-7**  
**Max Capacity Contours of Radius(m) Plots 2.1m Dipper**  
**Gradient 1 in -25 Height 2m Lift BP**  
**Unlocked Rail Cant -50mm**

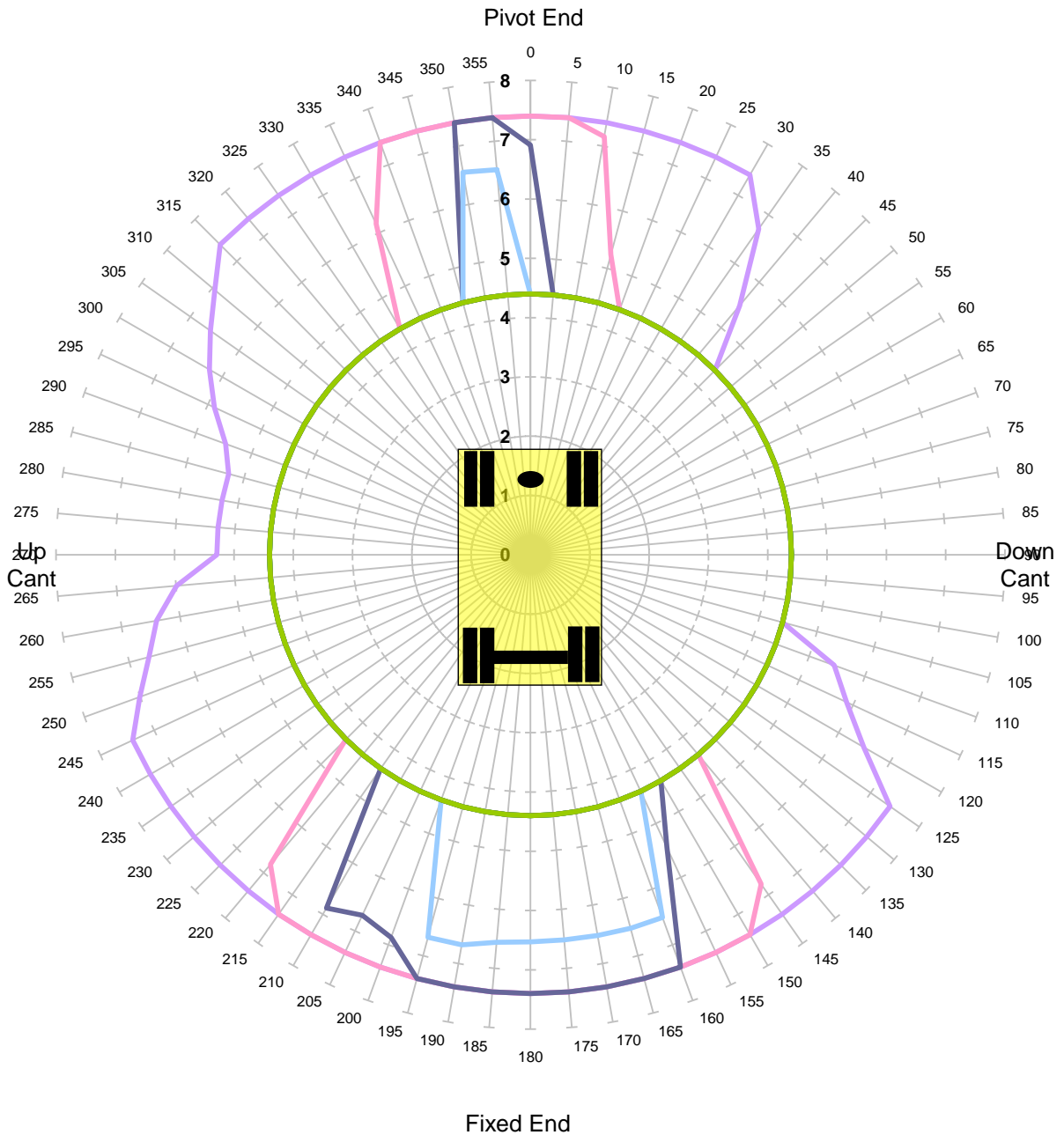

<b>MACHINE &amp; MODEL:</b>	Komatsu PW160-7	<b>REFERENCE:</b>	
<b>SERIAL No:</b>	H50093	<b>DATE OF CHART:</b>	19-Oct-2021
<b>EQUIPMENT:</b>	5.15m + 2.10m	<b>SAFETY FACTOR:</b>	67.0%
<b>COMMENT:</b>			

**Komatsu PW160-7**  
**Max Capacity Contours of Radius(m) Plots 2.1m Dipper**  
**Gradient 1 in -25 Height 2m Lift BP**  
**Unlocked Rail Cant 50mm**

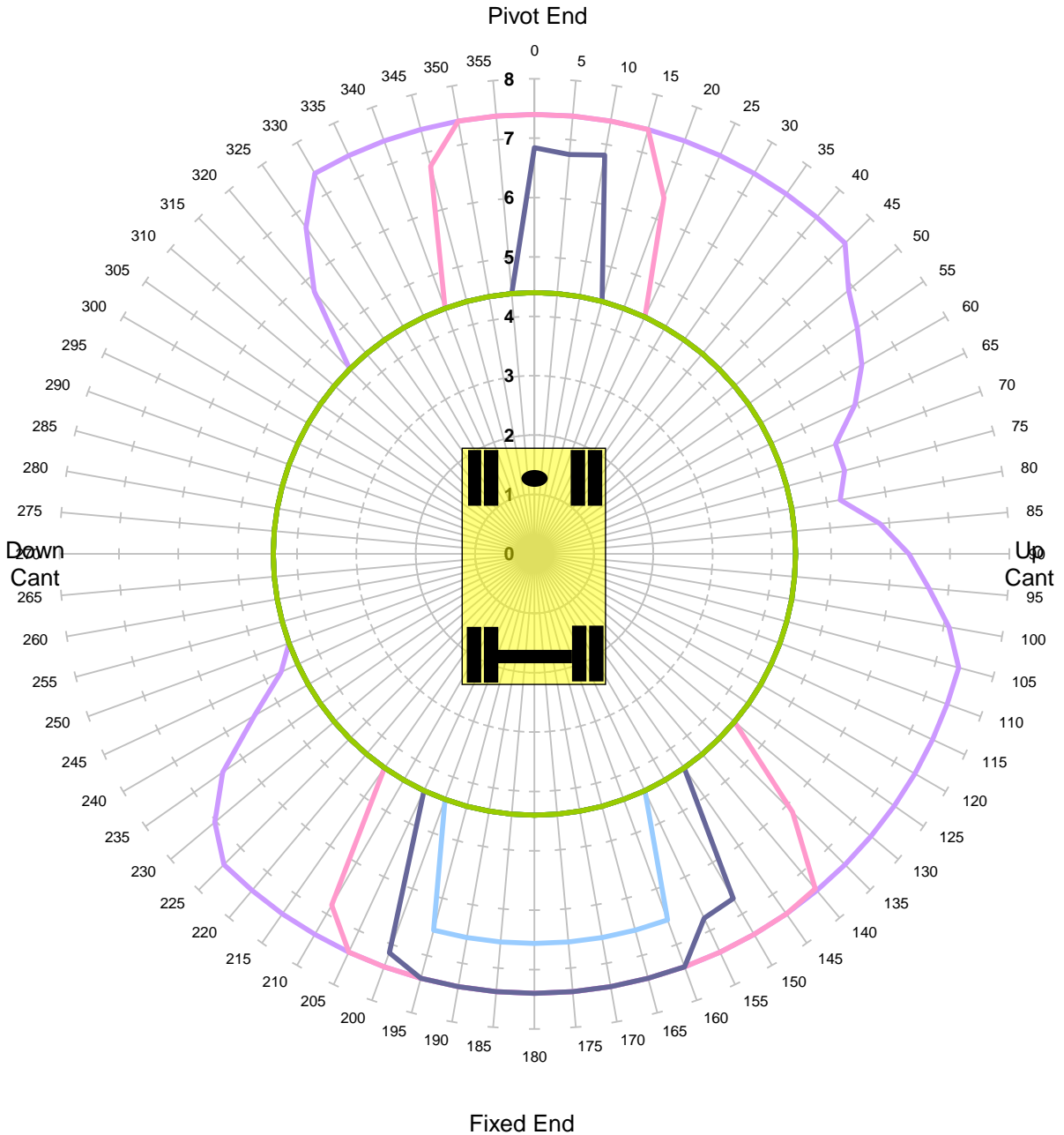

Units in Tonnes

- 1
- 2
- 3
- 4
- 5
- 6
- 7
- 8
- 9
- 10

<b>MACHINE &amp; MODEL:</b>	Komatsu PW160-7	<b>REFERENCE:</b>	
<b>SERIAL No:</b>	H50093	<b>DATE OF CHART:</b>	19-Oct-2021
<b>EQUIPMENT:</b>	5.15m + 2.10m	<b>SAFETY FACTOR:</b>	67.0%
<b>COMMENT:</b>			

**Komatsu PW160-7**  
**Max Capacity Contours of Radius(m) Plots 2.1m Dipper**  
**Gradient 1 in -25 Height 2m Lift BP**  
**Unlocked Rail Cant 150mm**

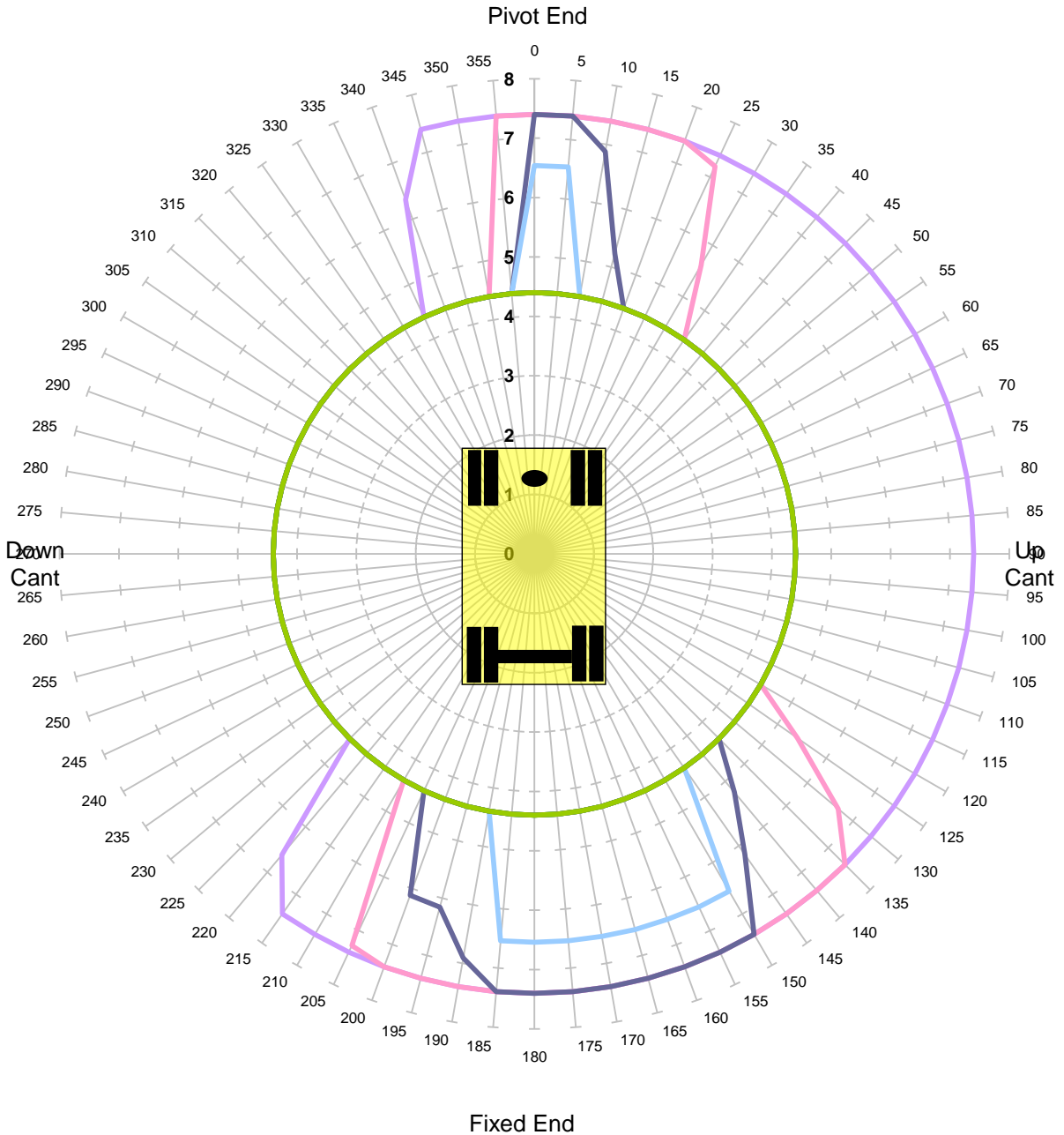

Units in Tonnes

- 1
- 2
- 3
- 4
- 5
- 6
- 7
- 8
- 9
- 10

<b>MACHINE &amp; MODEL:</b>	Komatsu PW160-7	<b>REFERENCE:</b>	
<b>SERIAL No:</b>	H50093	<b>DATE OF CHART:</b>	19-Oct-2021
<b>EQUIPMENT:</b>	5.15m + 2.10m	<b>SAFETY FACTOR:</b>	67.0%
<b>COMMENT:</b>			

**Komatsu PW160-7**  
**Max Capacity Contours of Radius(m) Plots 2.1m Dipper**  
**Gradient 1 in -25 Height 2m Lift BP**  
**Locked Rail Cant -150mm**

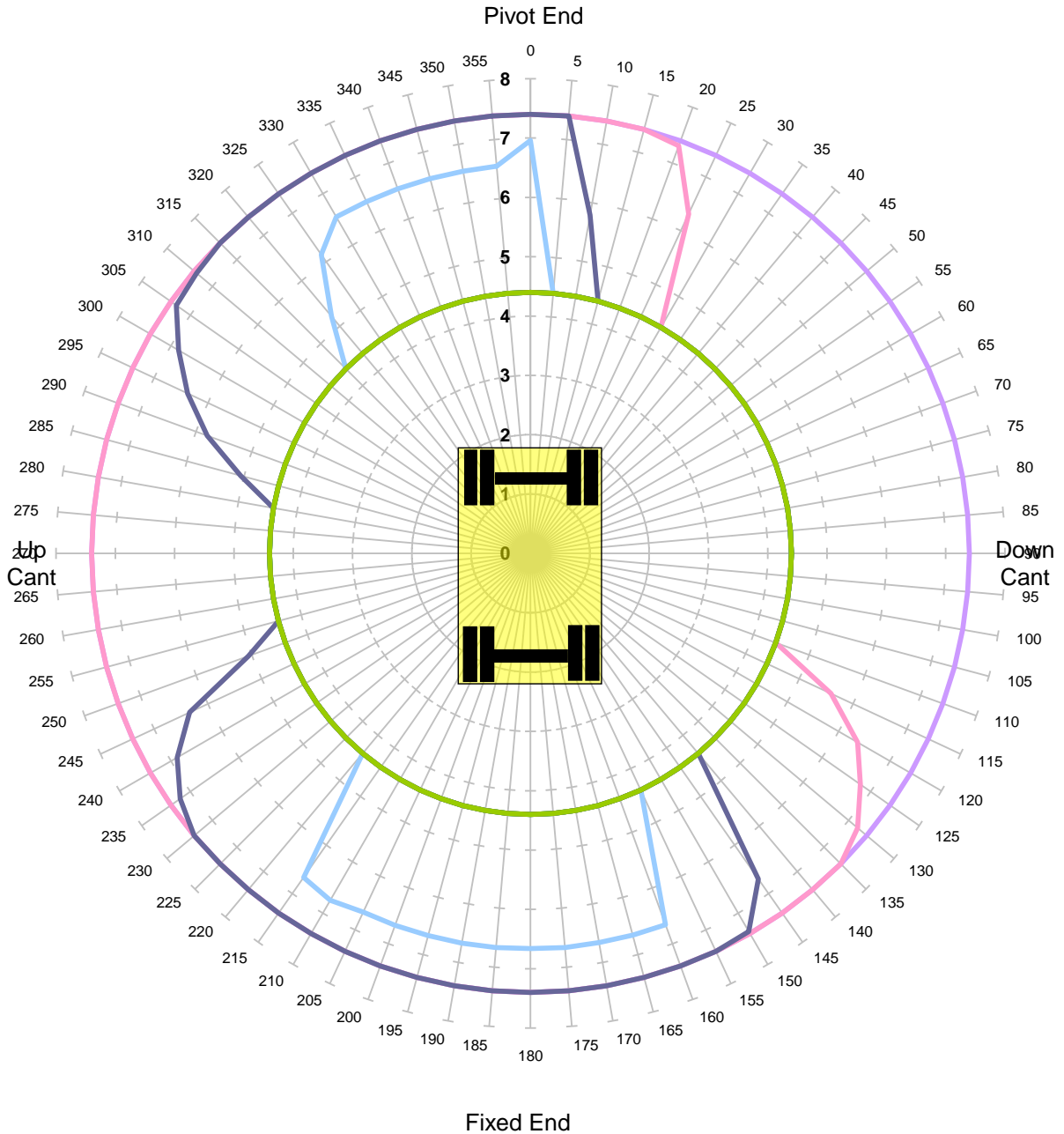

Units in Tonnes

- 1
- 2
- 3
- 4
- 5
- 6
- 7
- 8
- 9
- 10

<b>MACHINE &amp; MODEL:</b>	Komatsu PW160-7	<b>REFERENCE:</b>	
<b>SERIAL No:</b>	H50093	<b>DATE OF CHART:</b>	19-Oct-2021
<b>EQUIPMENT:</b>	5.15m + 2.10m	<b>SAFETY FACTOR:</b>	90.0%
<b>COMMENT:</b>			

**Komatsu PW160-7**  
**Max Capacity Contours of Radius(m) Plots 2.1m Dipper**  
**Gradient 1 in -25 Height 2m Lift BP**  
**Locked Rail Cant -50mm**

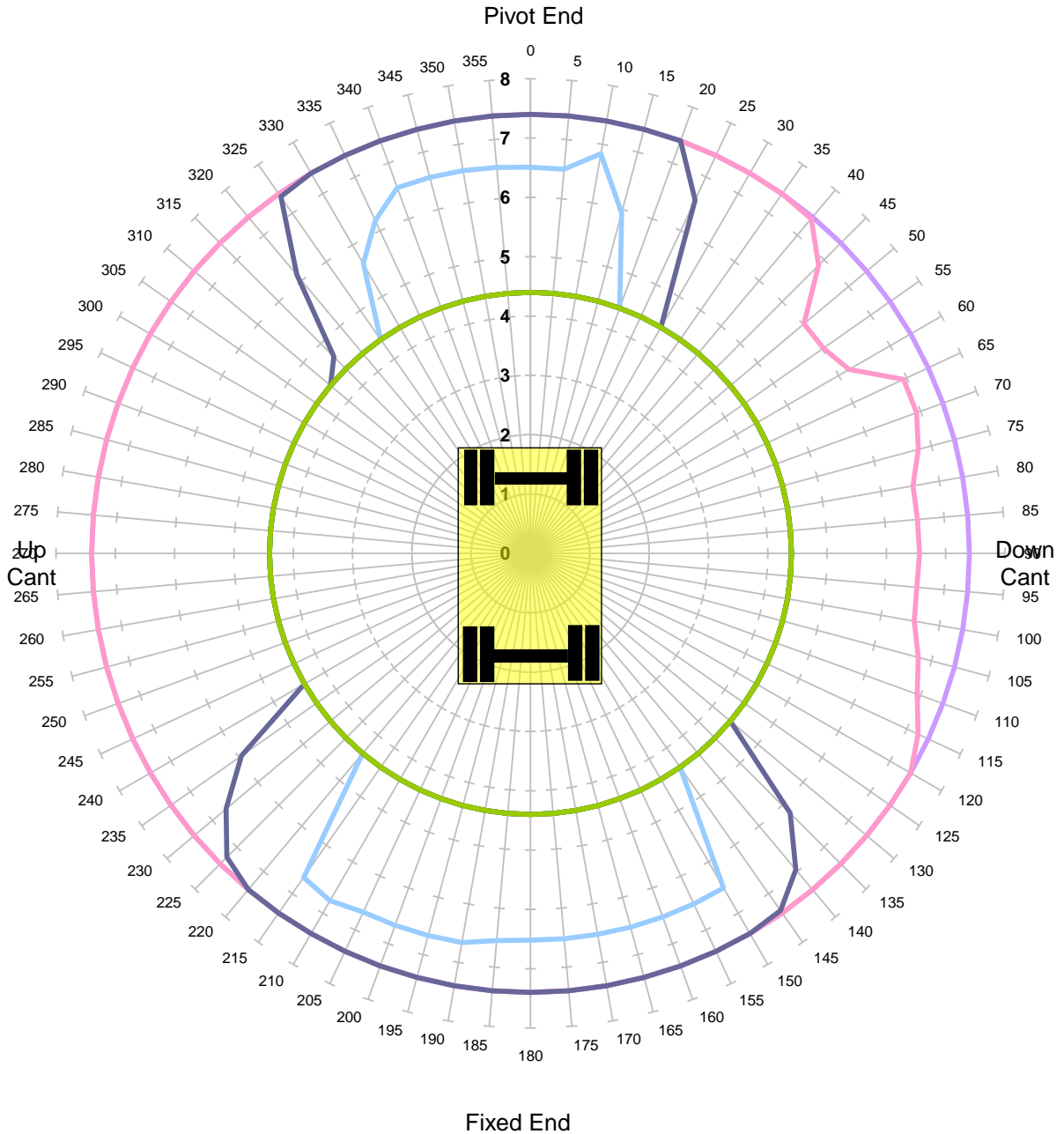

Units in Tonnes

- 1
- 2
- 3
- 4
- 5
- 6
- 7
- 8
- 9
- 10

<b>MACHINE &amp; MODEL:</b>	Komatsu PW160-7	<b>REFERENCE:</b>	
<b>SERIAL No:</b>	H50093	<b>DATE OF CHART:</b>	19-Oct-2021
<b>EQUIPMENT:</b>	5.15m + 2.10m	<b>SAFETY FACTOR:</b>	90.0%
<b>COMMENT:</b>			

**Komatsu PW160-7**  
**Max Capacity Contours of Radius(m) Plots 2.1m Dipper**  
**Gradient 1 in -25 Height 2m Lift BP**  
**Locked Rail Cant 50mm**

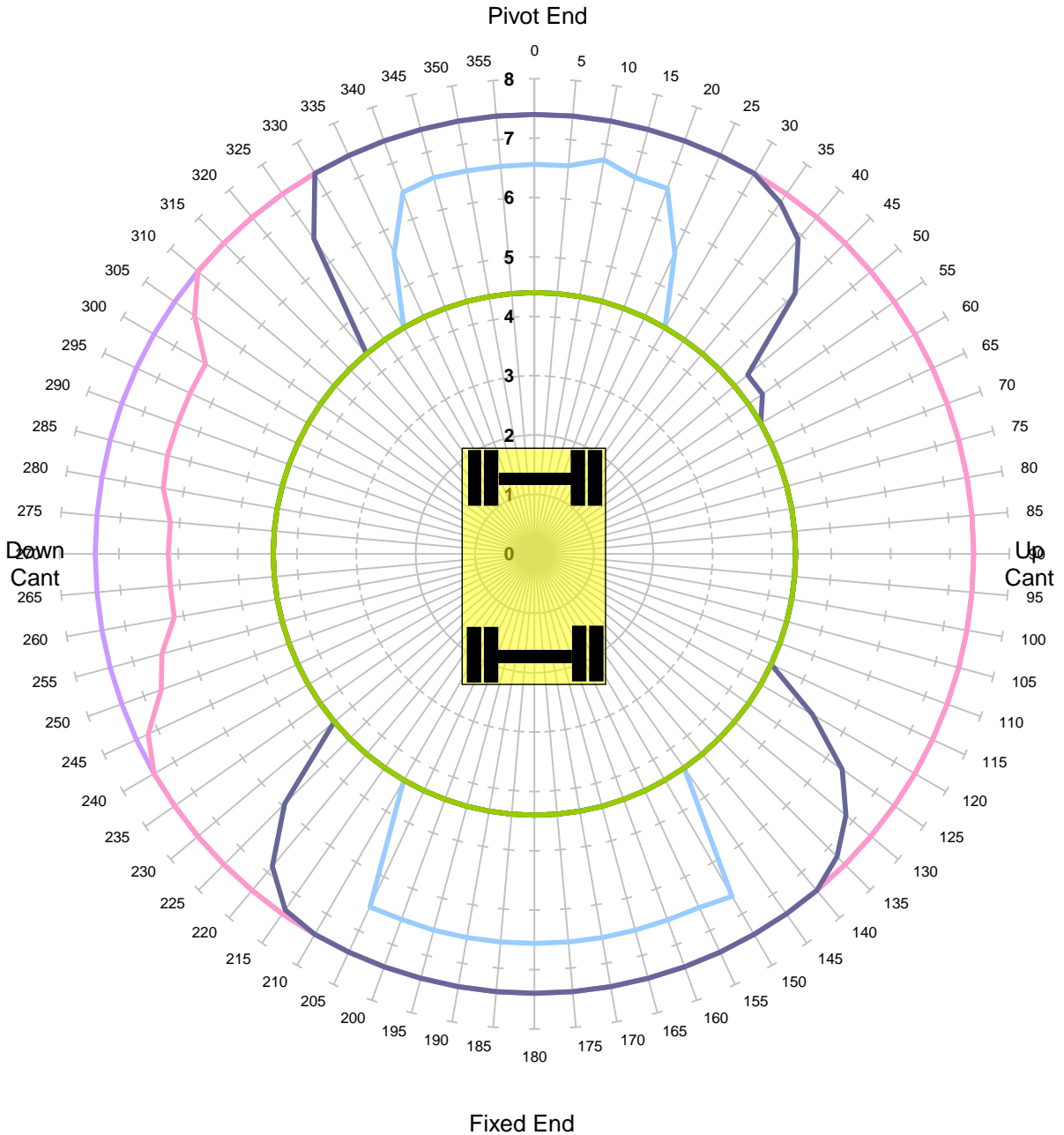

Units in Tonnes

- 1
- 2
- 3
- 4
- 5
- 6
- 7
- 8
- 9
- 10

<b>MACHINE &amp; MODEL:</b>	Komatsu PW160-7	<b>REFERENCE:</b>	
<b>SERIAL No:</b>	H50093	<b>DATE OF CHART:</b>	19-Oct-2021
<b>EQUIPMENT:</b>	5.15m + 2.10m	<b>SAFETY FACTOR:</b>	90.0%
<b>COMMENT:</b>			

**Komatsu PW160-7**  
**Max Capacity Contours of Radius(m) Plots 2.1m Dipper**  
**Gradient 1 in -25 Height 2m Lift BP**  
**Locked Rail Cant 150mm**

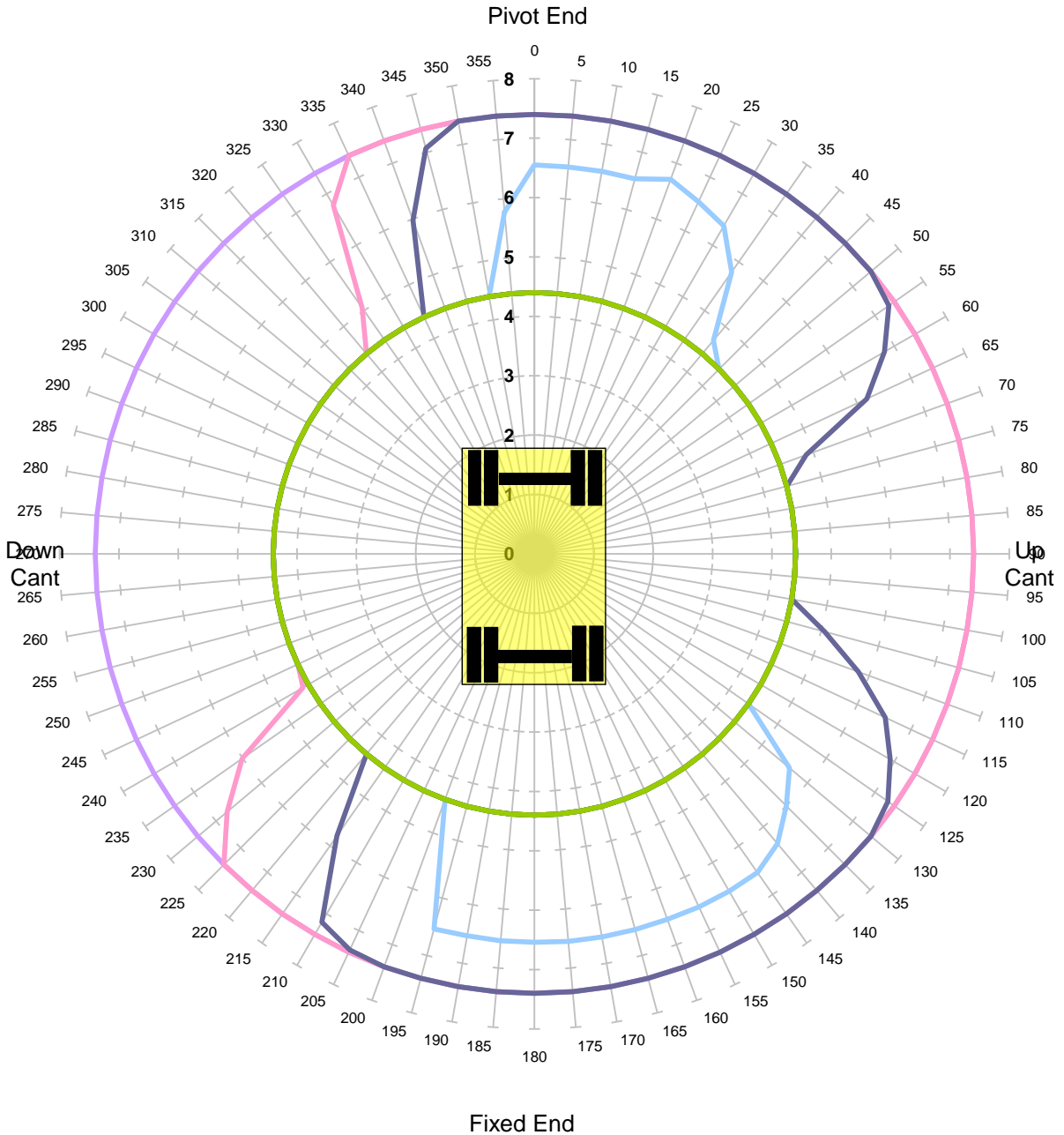

Units in Tonnes

- 1
- 2
- 3
- 4
- 5
- 6
- 7
- 8
- 9
- 10

<b>MACHINE &amp; MODEL:</b>	Komatsu PW160-7	<b>REFERENCE:</b>	
<b>SERIAL No:</b>	H50093	<b>DATE OF CHART:</b>	19-Oct-2021
<b>EQUIPMENT:</b>	5.15m + 2.10m	<b>SAFETY FACTOR:</b>	90.0%
<b>COMMENT:</b>			



**Komatsu PW160-7**  
**Max Capacity Contours of Radius(m) Plots 2.1m Dipper**  
**Level Ground Height 2m Lift BP**  
**Unlocked Road**

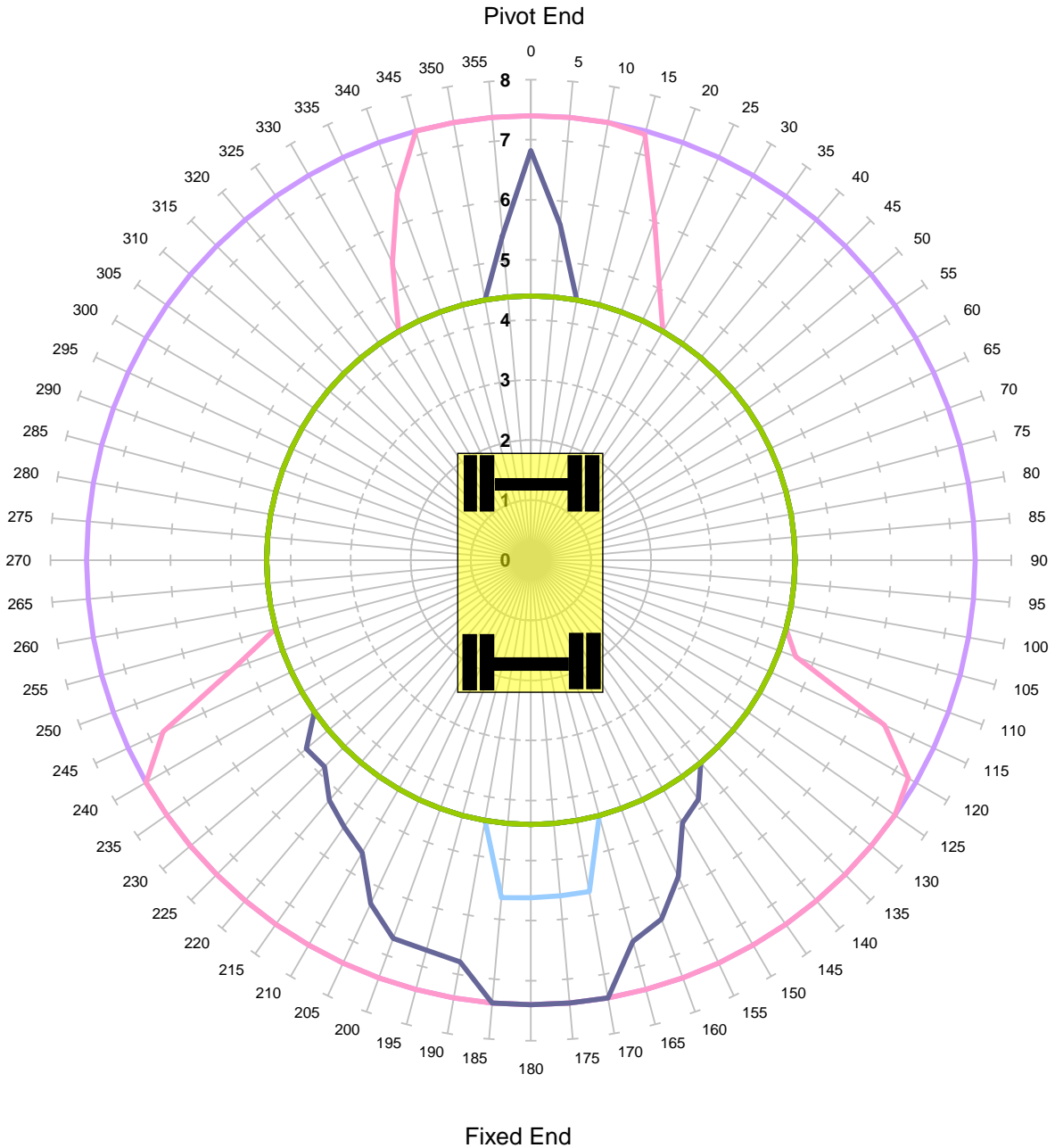

Units in Tonnes

- 1
- 2
- 3
- 4
- 5
- 6
- 7
- 8
- 9
- 10

<b>MACHINE &amp; MODEL:</b>	Komatsu PW160-7	<b>REFERENCE:</b>	
<b>SERIAL No:</b>	H50093	<b>DATE OF CHART:</b>	19-Oct-2021
<b>EQUIPMENT:</b>	5.15m + 2.10m	<b>SAFETY FACTOR:</b>	71.0%
<b>COMMENT:</b>			

**Komatsu PW160-7**  
**Max Capacity Contours of Radius(m) Plots 2.1m Dipper**  
**Level Ground Height 2m Lift BP**  
**Locked Road**

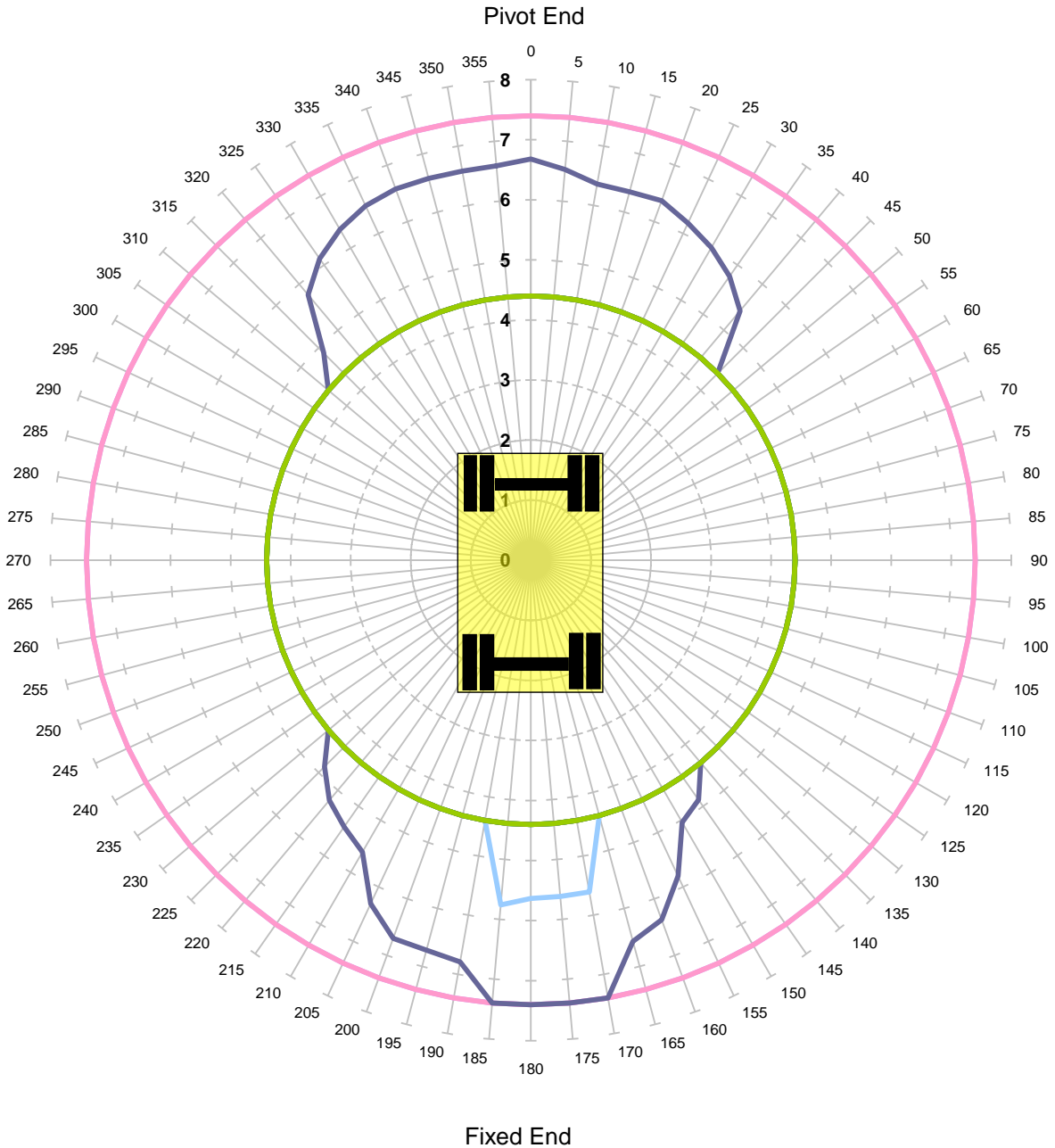

Units in Tonnes

- 1
- 2
- 3
- 4
- 5
- 6
- 7
- 8
- 9
- 10

<b>MACHINE &amp; MODEL:</b>	Komatsu PW160-7	<b>REFERENCE:</b>	
<b>SERIAL No:</b>	H50093	<b>DATE OF CHART:</b>	19-Oct-2021
<b>EQUIPMENT:</b>	5.15m + 2.10m	<b>SAFETY FACTOR:</b>	71.0%
<b>COMMENT:</b>			

**Komatsu PW160-7**  
**Max Capacity Contours of Radius(m) Plots 2.1m Dipper**  
**Gradient 1 in -25 Height 2m Lift BP**  
**Unlocked Rail Cant -150mm - Tandem Lift**

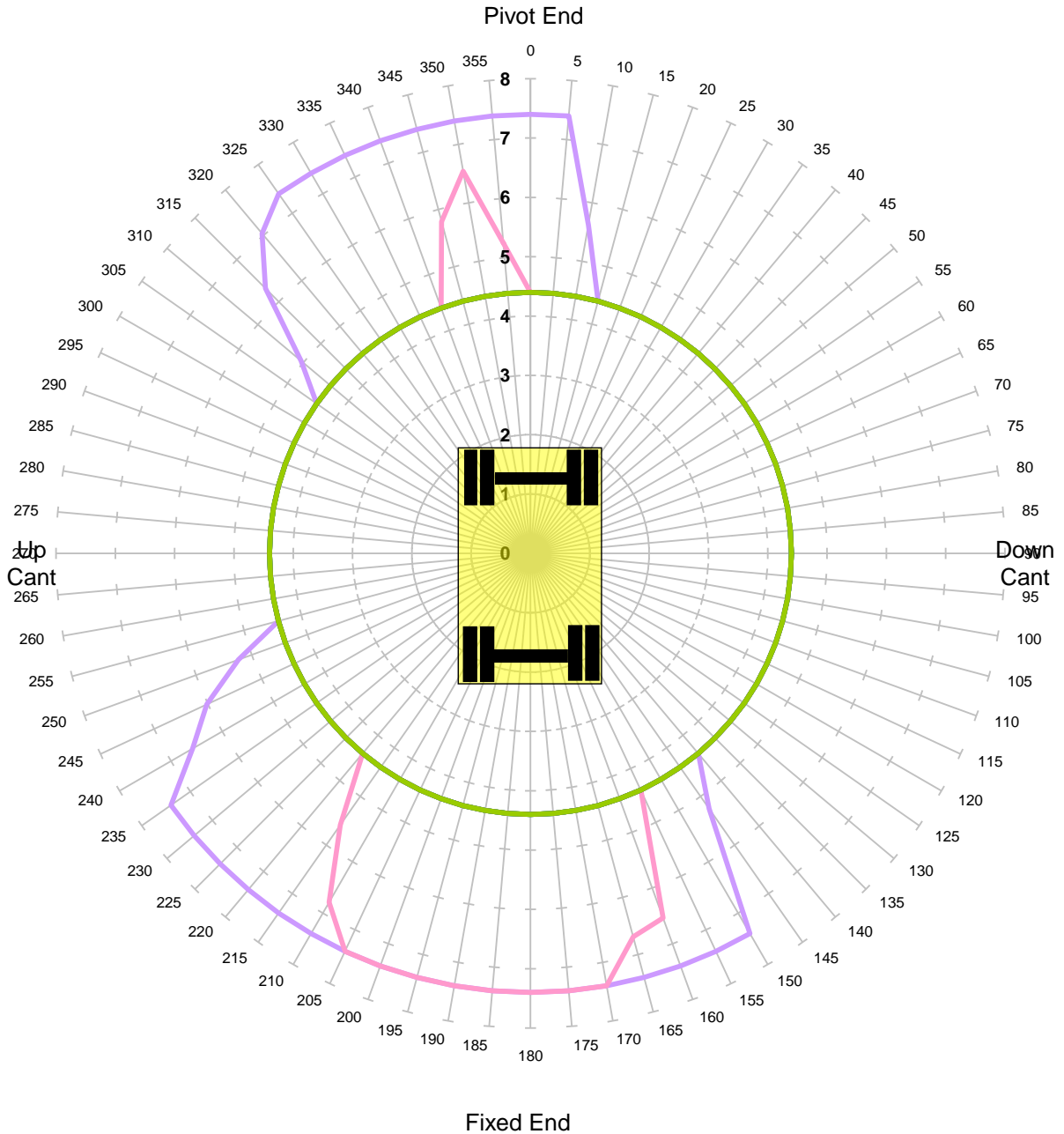

<b>MACHINE &amp; MODEL:</b>	Komatsu PW160-7	<b>REFERENCE:</b>	
<b>SERIAL No:</b>	H50093	<b>DATE OF CHART:</b>	19-Oct-2021
<b>EQUIPMENT:</b>	5.15m + 2.10m	<b>SAFETY FACTOR:</b>	44.0%
<b>COMMENT:</b>			

**Komatsu PW160-7**  
**Max Capacity Contours of Radius(m) Plots 2.1m Dipper**  
**Gradient 1 in -25 Height 2m Lift BP**  
**Unlocked Rail Cant -50mm - Tandem Lift**

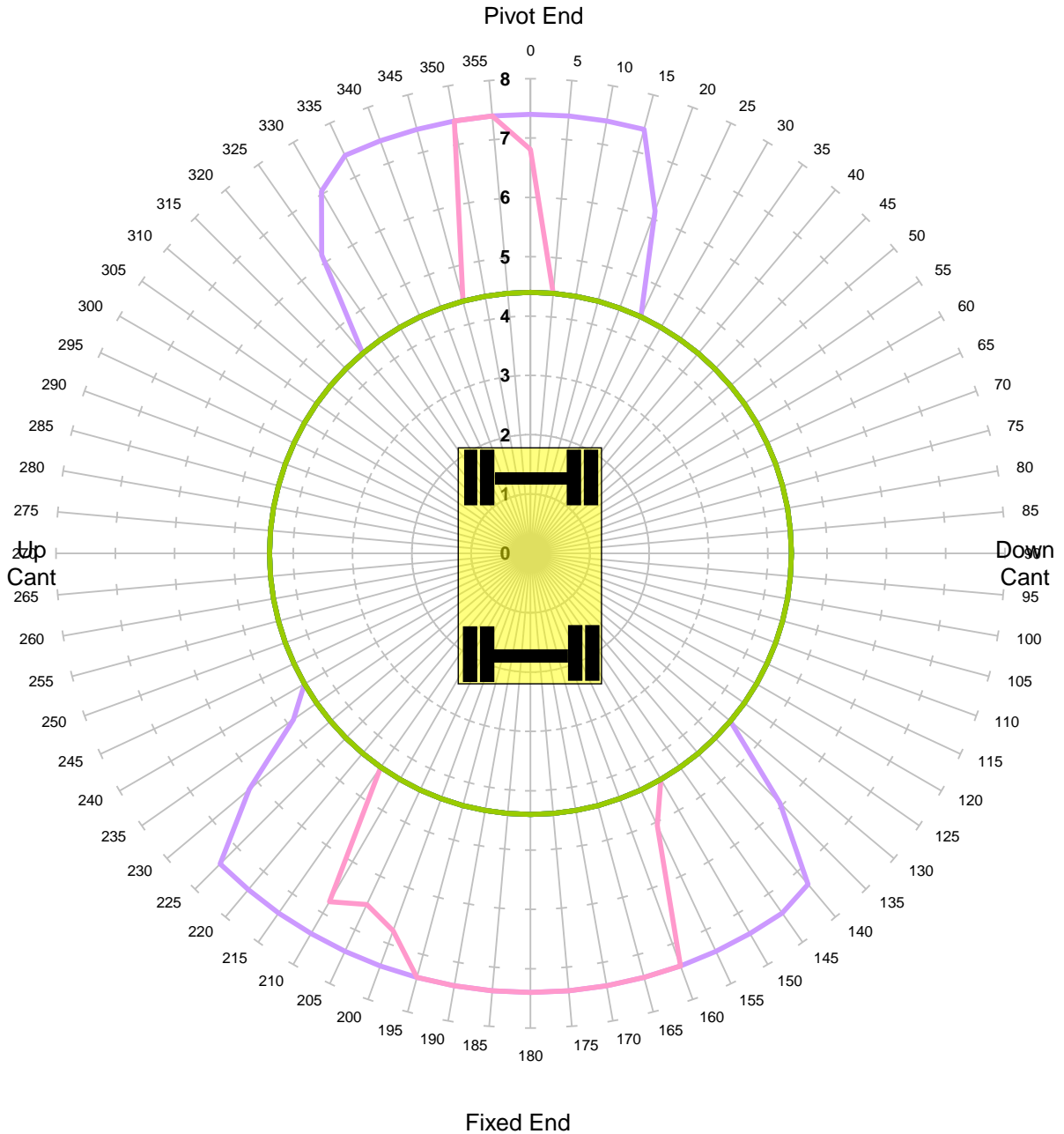

Units in Tonnes

- 1
- 2
- 3
- 4
- 5
- 6
- 7
- 8
- 9
- 10

<b>MACHINE &amp; MODEL:</b>	Komatsu PW160-7	<b>REFERENCE:</b>	
<b>SERIAL No:</b>	H50093	<b>DATE OF CHART:</b>	19-Oct-2021
<b>EQUIPMENT:</b>	5.15m + 2.10m	<b>SAFETY FACTOR:</b>	44.0%
<b>COMMENT:</b>			

**Komatsu PW160-7**  
**Max Capacity Contours of Radius(m) Plots 2.1m Dipper**  
**Gradient 1 in -25 Height 2m Lift BP**  
**Unlocked Rail Cant 50mm - Tandem Lift**

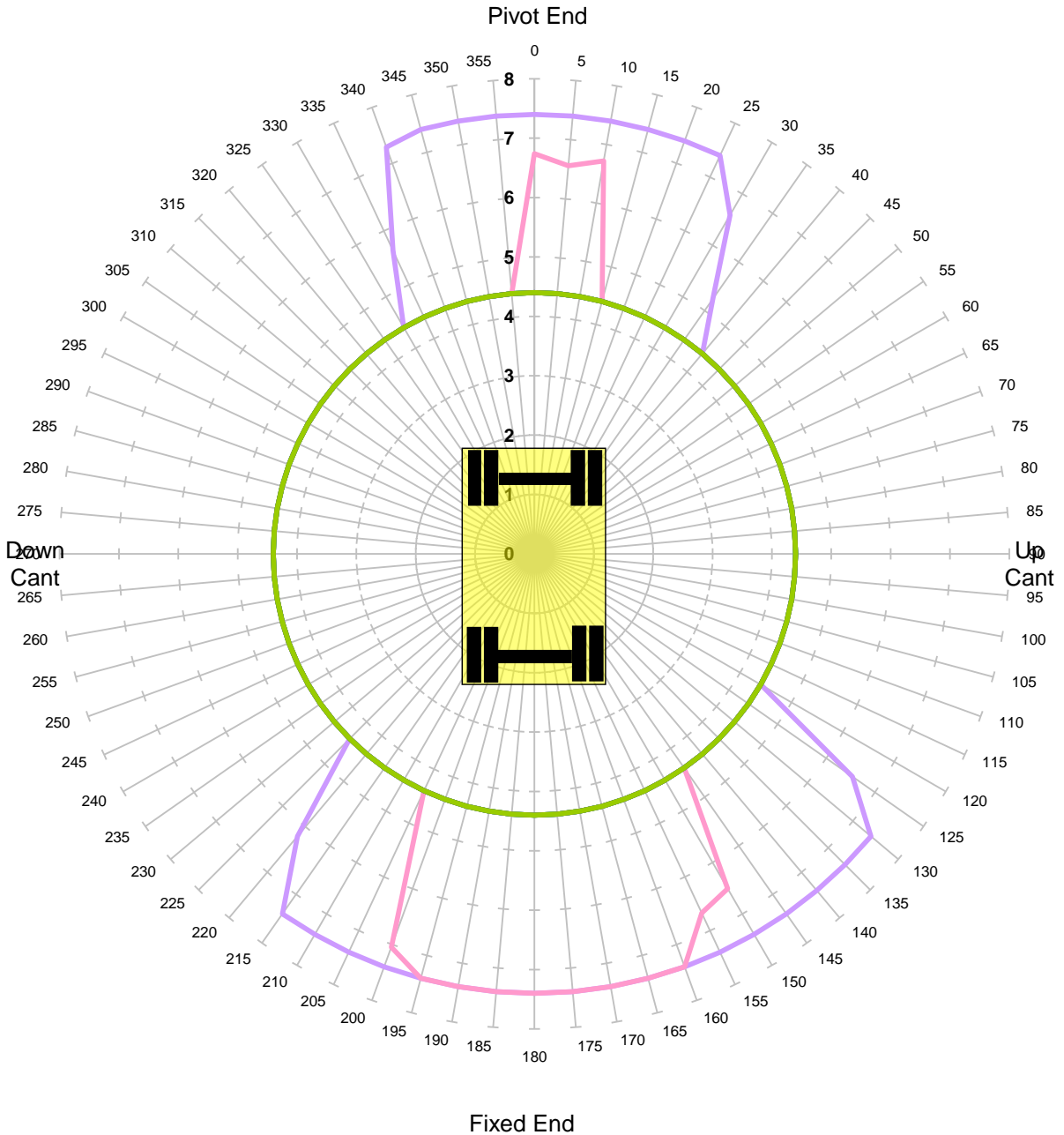

Units in Tonnes



<b>MACHINE &amp; MODEL:</b>	Komatsu PW160-7	<b>REFERENCE:</b>	
<b>SERIAL No:</b>	H50093	<b>DATE OF CHART:</b>	19-Oct-2021
<b>EQUIPMENT:</b>	5.15m + 2.10m	<b>SAFETY FACTOR:</b>	44.0%
<b>COMMENT:</b>			

**Komatsu PW160-7**  
**Max Capacity Contours of Radius(m) Plots 2.1m Dipper**  
**Gradient 1 in -25 Height 2m Lift BP**  
**Unlocked Rail Cant 150mm - Tandem Lift**

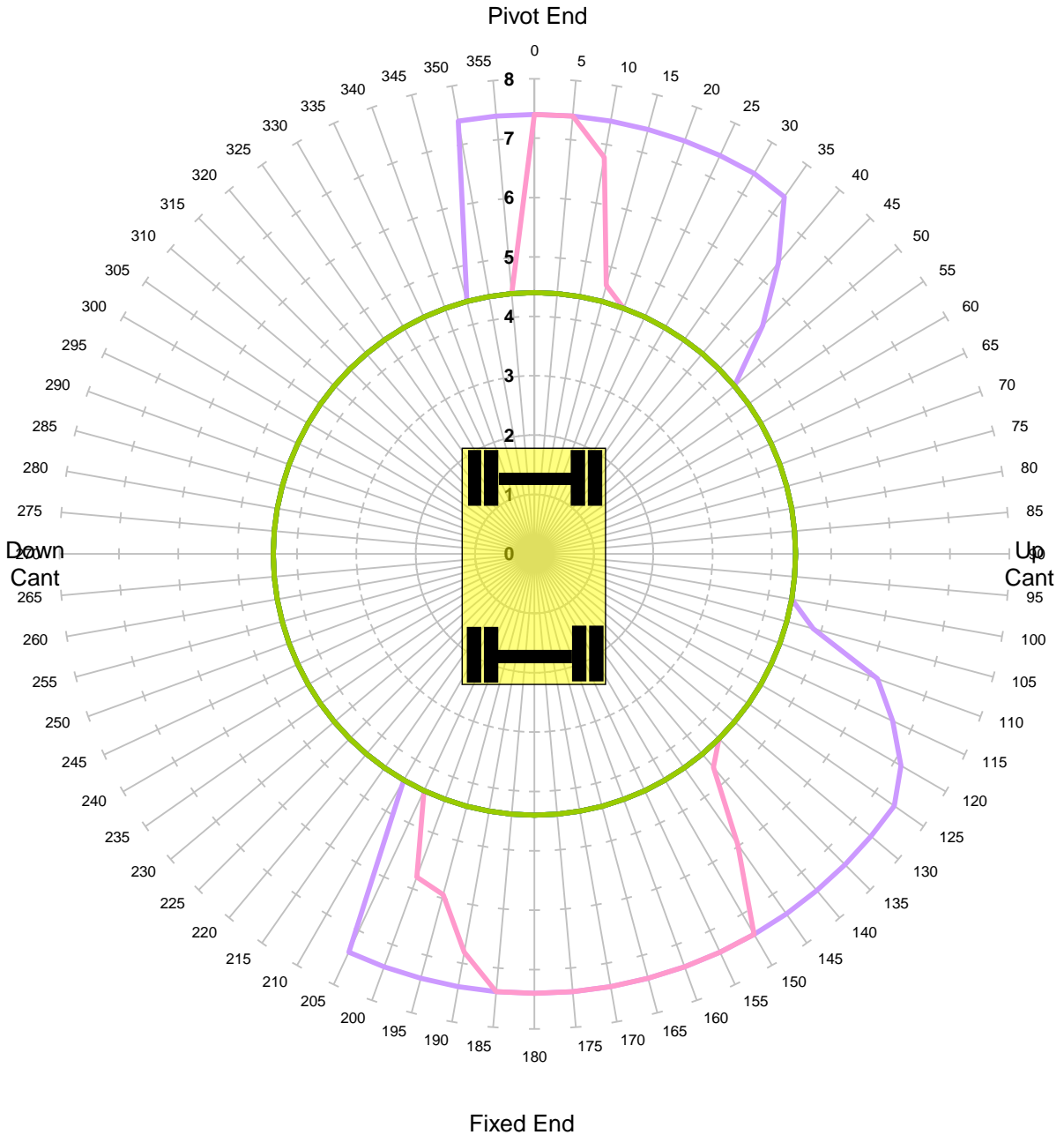

Units in Tonnes



<b>MACHINE &amp; MODEL:</b>	Komatsu PW160-7	<b>REFERENCE:</b>	
<b>SERIAL No:</b>	H50093	<b>DATE OF CHART:</b>	19-Oct-2021
<b>EQUIPMENT:</b>	5.15m + 2.10m	<b>SAFETY FACTOR:</b>	44.0%
<b>COMMENT:</b>			

**Komatsu PW160-7**  
**Max Capacity Contours of Radius(m) Plots 2.1m Dipper**  
**Gradient 1 in -25 Height 2m Lift BP**  
**Locked Rail Cant -150mm - Tandem Lift**

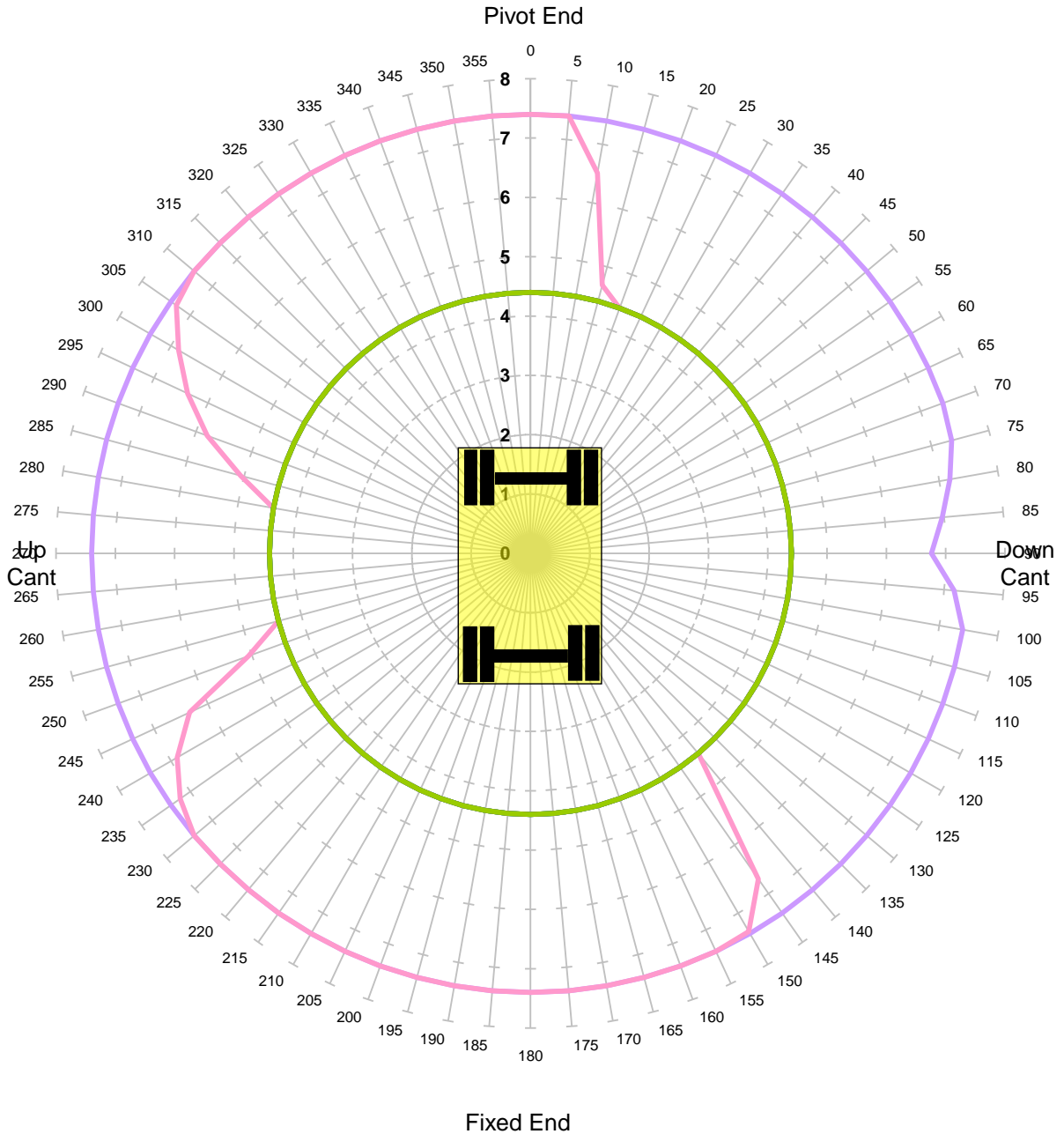

Units in Tonnes

- 1
- 2
- 3
- 4
- 5
- 6
- 7
- 8
- 9
- 10

<b>MACHINE &amp; MODEL:</b>	Komatsu PW160-7	<b>REFERENCE:</b>	
<b>SERIAL No:</b>	H50093	<b>DATE OF CHART:</b>	19-Oct-2021
<b>EQUIPMENT:</b>	5.15m + 2.10m	<b>SAFETY FACTOR:</b>	59.0%
<b>COMMENT:</b>			

**Komatsu PW160-7**  
**Max Capacity Contours of Radius(m) Plots 2.1m Dipper**  
**Gradient 1 in -25 Height 2m Lift BP**  
**Locked Rail Cant -50mm - Tandem Lift**

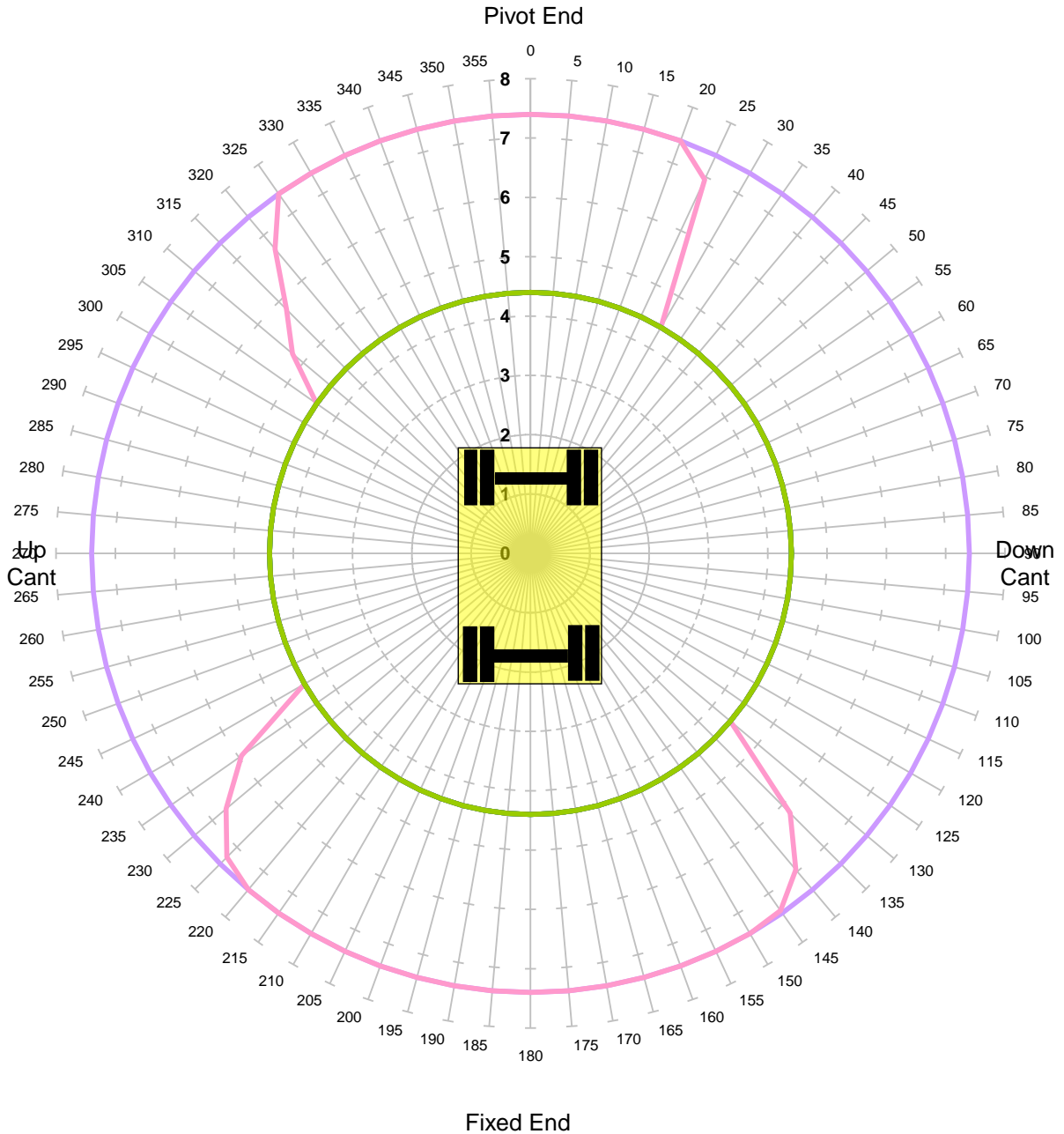

Units in Tonnes

- 1
- 2
- 3
- 4
- 5
- 6
- 7
- 8
- 9
- 10

<b>MACHINE &amp; MODEL:</b>	Komatsu PW160-7	<b>REFERENCE:</b>	
<b>SERIAL No:</b>	H50093	<b>DATE OF CHART:</b>	19-Oct-2021
<b>EQUIPMENT:</b>	5.15m + 2.10m	<b>SAFETY FACTOR:</b>	59.0%
<b>COMMENT:</b>			



**Komatsu PW160-7**  
**Max Capacity Contours of Radius(m) Plots 2.1m Dipper**  
**Gradient 1 in -25 Height 2m Lift BP**  
**Locked Rail Cant 50mm - Tandem Lift**

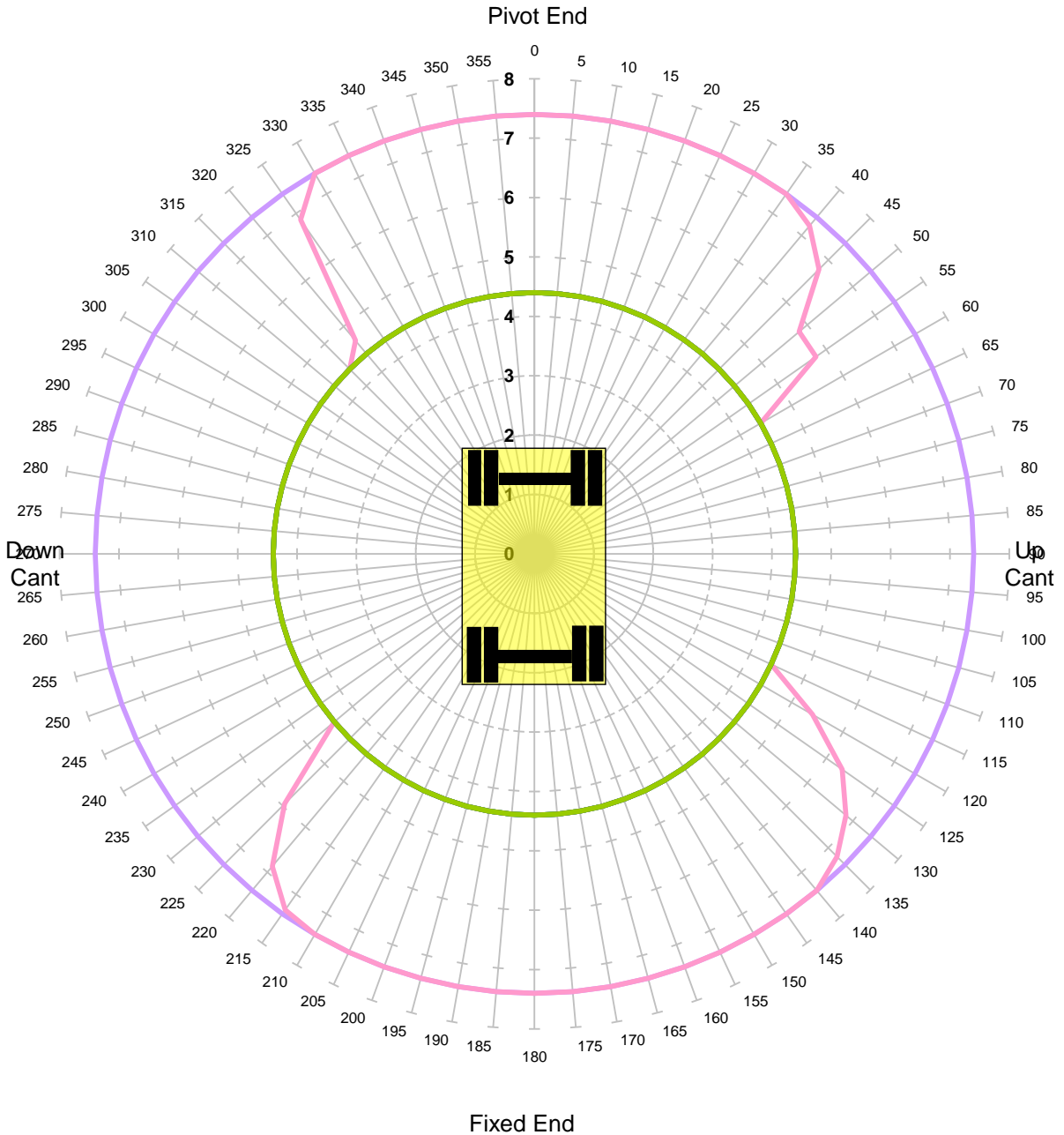

Units in Tonnes

- 1
- 2
- 3
- 4
- 5
- 6
- 7
- 8
- 9
- 10

<b>MACHINE &amp; MODEL:</b>	Komatsu PW160-7	<b>REFERENCE:</b>	
<b>SERIAL No:</b>	H50093	<b>DATE OF CHART:</b>	19-Oct-2021
<b>EQUIPMENT:</b>	5.15m + 2.10m	<b>SAFETY FACTOR:</b>	59.0%
<b>COMMENT:</b>			

**Komatsu PW160-7**  
**Max Capacity Contours of Radius(m) Plots 2.1m Dipper**  
**Gradient 1 in -25 Height 2m Lift BP**  
**Locked Rail Cant 150mm - Tandem Lift**

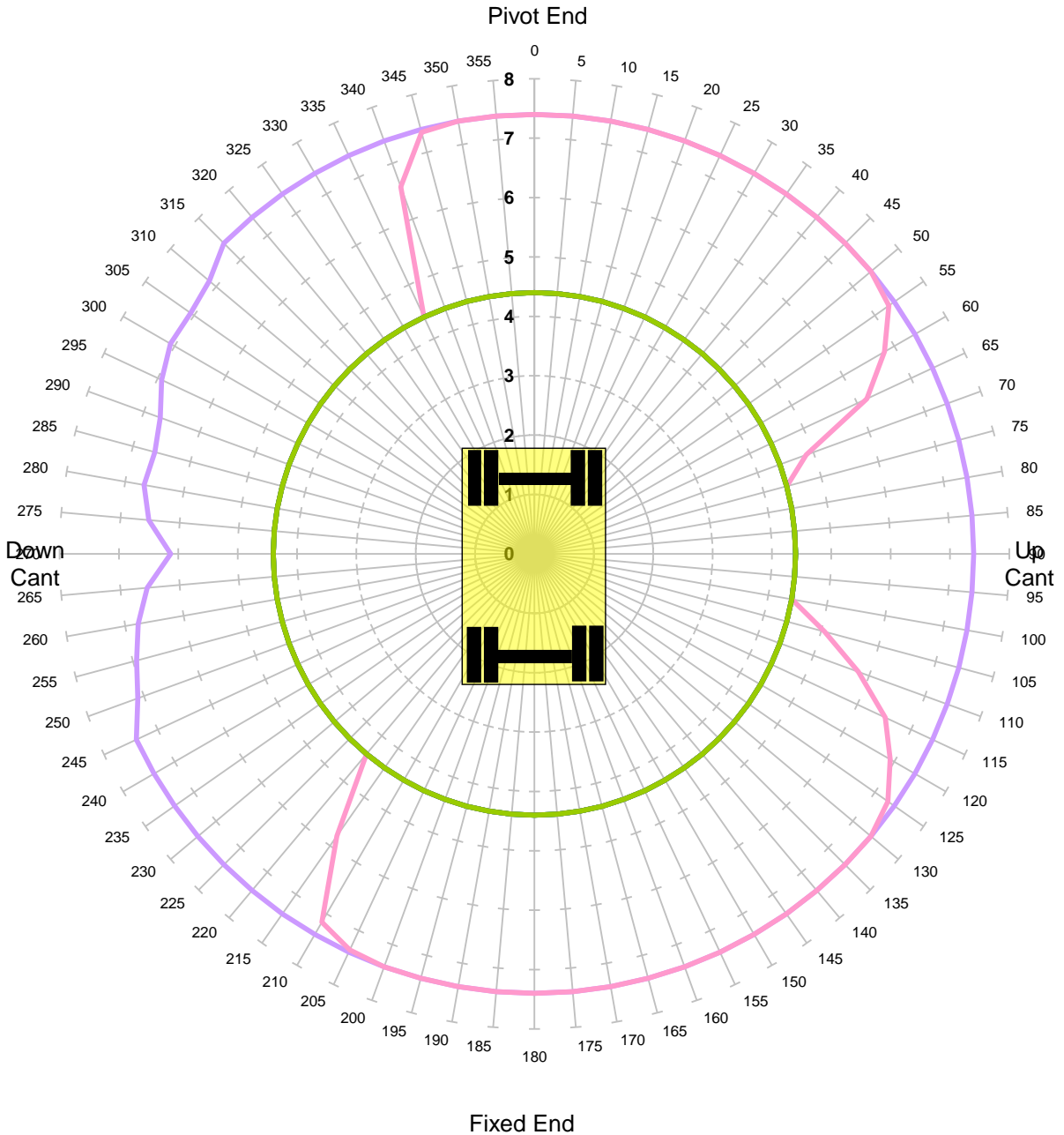

Units in Tonnes

- 1
- 2
- 3
- 4
- 5
- 6
- 7
- 8
- 9
- 10

<b>MACHINE &amp; MODEL:</b>	Komatsu PW160-7	<b>REFERENCE:</b>	
<b>SERIAL No:</b>	H50093	<b>DATE OF CHART:</b>	19-Oct-2021
<b>EQUIPMENT:</b>	5.15m + 2.10m	<b>SAFETY FACTOR:</b>	59.0%
<b>COMMENT:</b>			

**Komatsu PW160-7**  
**Max Capacity Contours of Radius(m) Plots 2.1m Dipper**  
**Level Ground Height 2m Lift BP**  
**Unlocked Road - Tandem Lift**

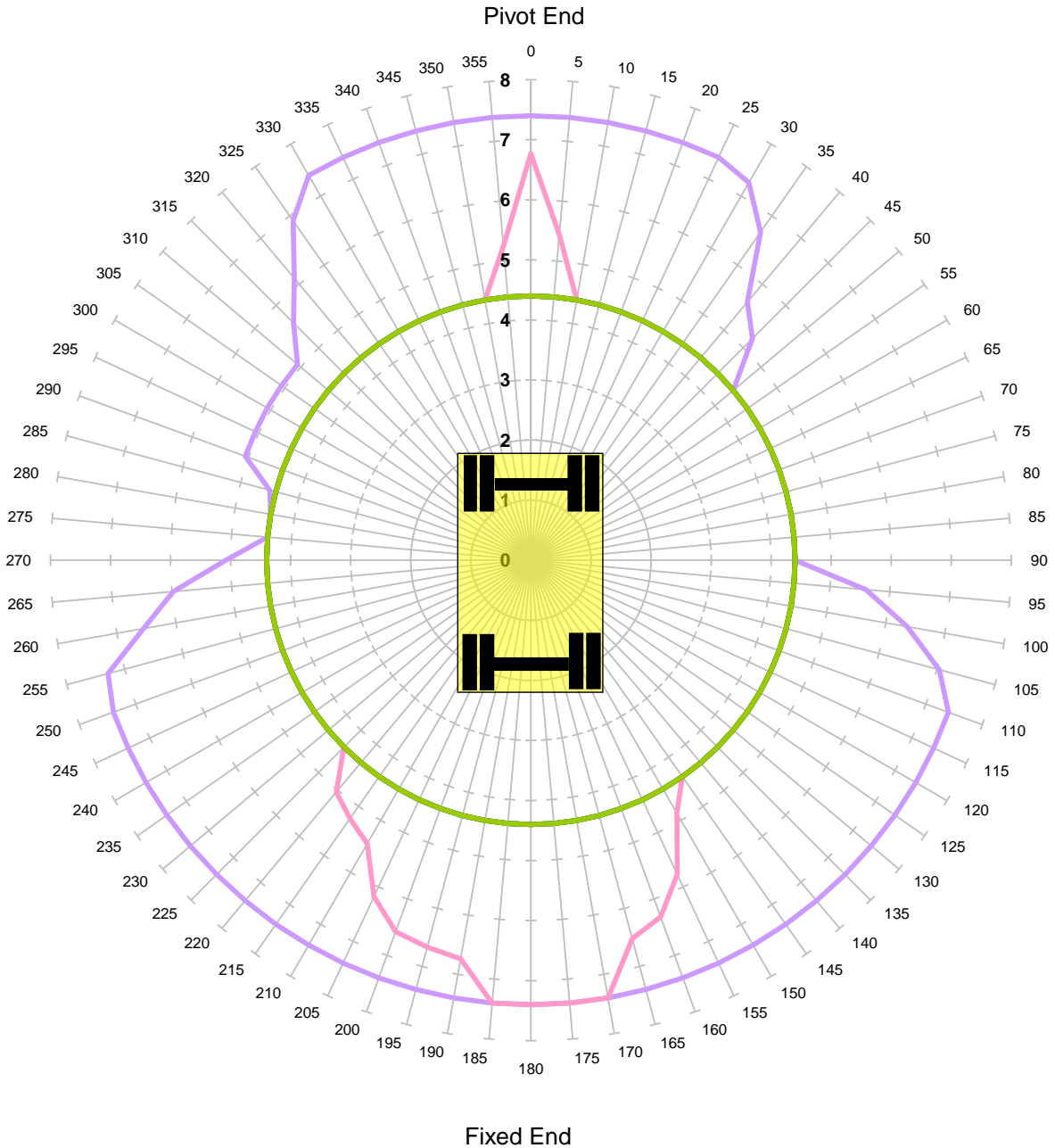

Units in Tonnes

- 1
- 2
- 3
- 4
- 5
- 6
- 7
- 8
- 9
- 10

<b>MACHINE &amp; MODEL:</b>	Komatsu PW160-7	<b>REFERENCE:</b>	
<b>SERIAL No:</b>	H50093	<b>DATE OF CHART:</b>	19-Oct-2021
<b>EQUIPMENT:</b>	5.15m + 2.10m	<b>SAFETY FACTOR:</b>	47.0%
<b>COMMENT:</b>			

**Komatsu PW160-7**  
**Max Capacity Contours of Radius(m) Plots 2.1m Dipper**  
**Level Ground Height 2m Lift BP**  
**Locked Road - Tandem Lift**

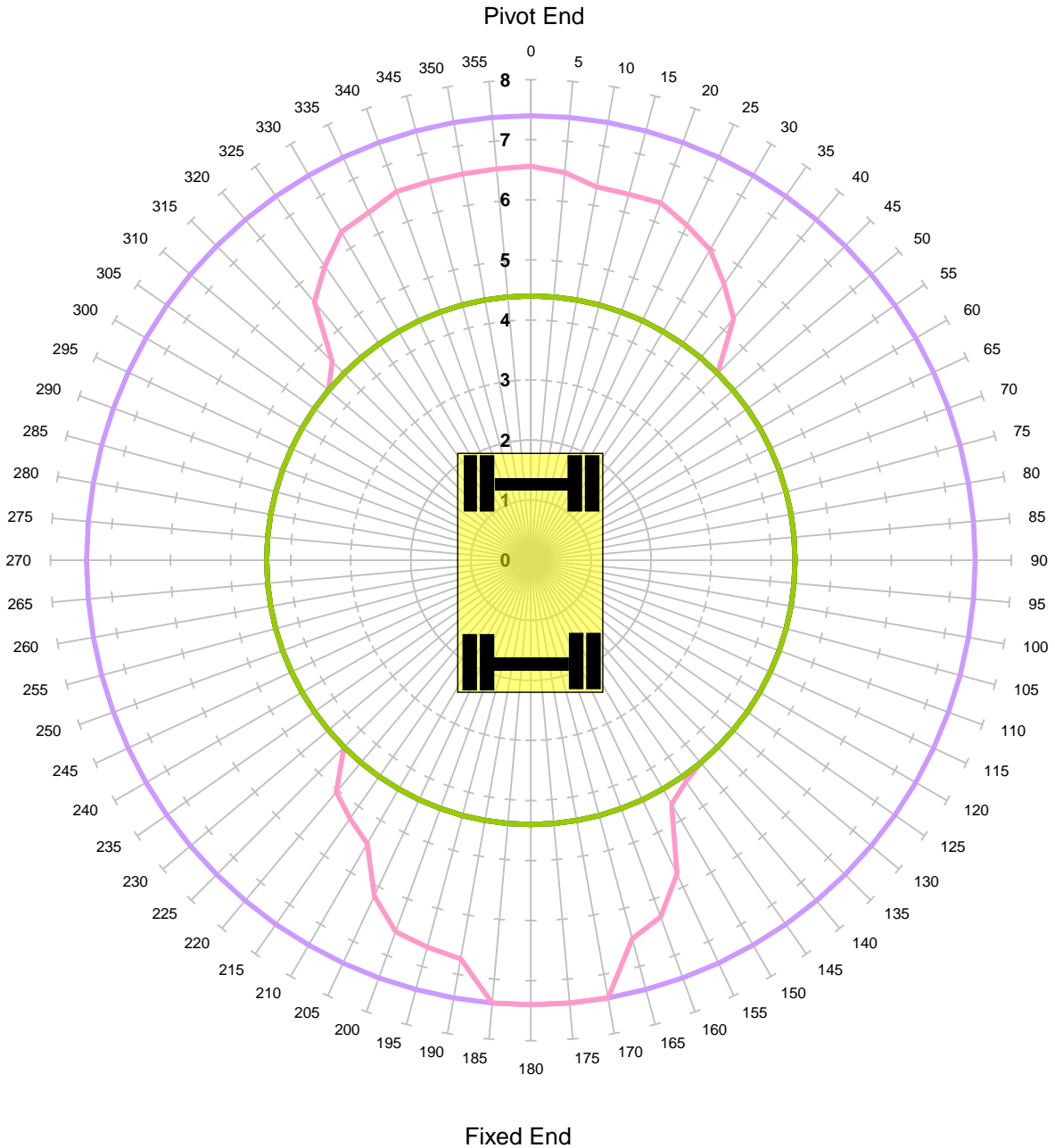

Units in Tonnes

- 1
- 2
- 3
- 4
- 5
- 6
- 7
- 8
- 9
- 10

<b>MACHINE &amp; MODEL:</b>	Komatsu PW160-7	<b>REFERENCE:</b>	
<b>SERIAL No:</b>	H50093	<b>DATE OF CHART:</b>	19-Oct-2021
<b>EQUIPMENT:</b>	5.15m + 2.10m	<b>SAFETY FACTOR:</b>	47.0%
<b>COMMENT:</b>			

**Komatsu PW160-7**  
**Max Capacity Contours of Radius(m) Plots 2.1m Dipper**  
**Gradient 1 in -25 Height 2m Lift ALP1**  
**Unlocked Rail Cant -150mm**

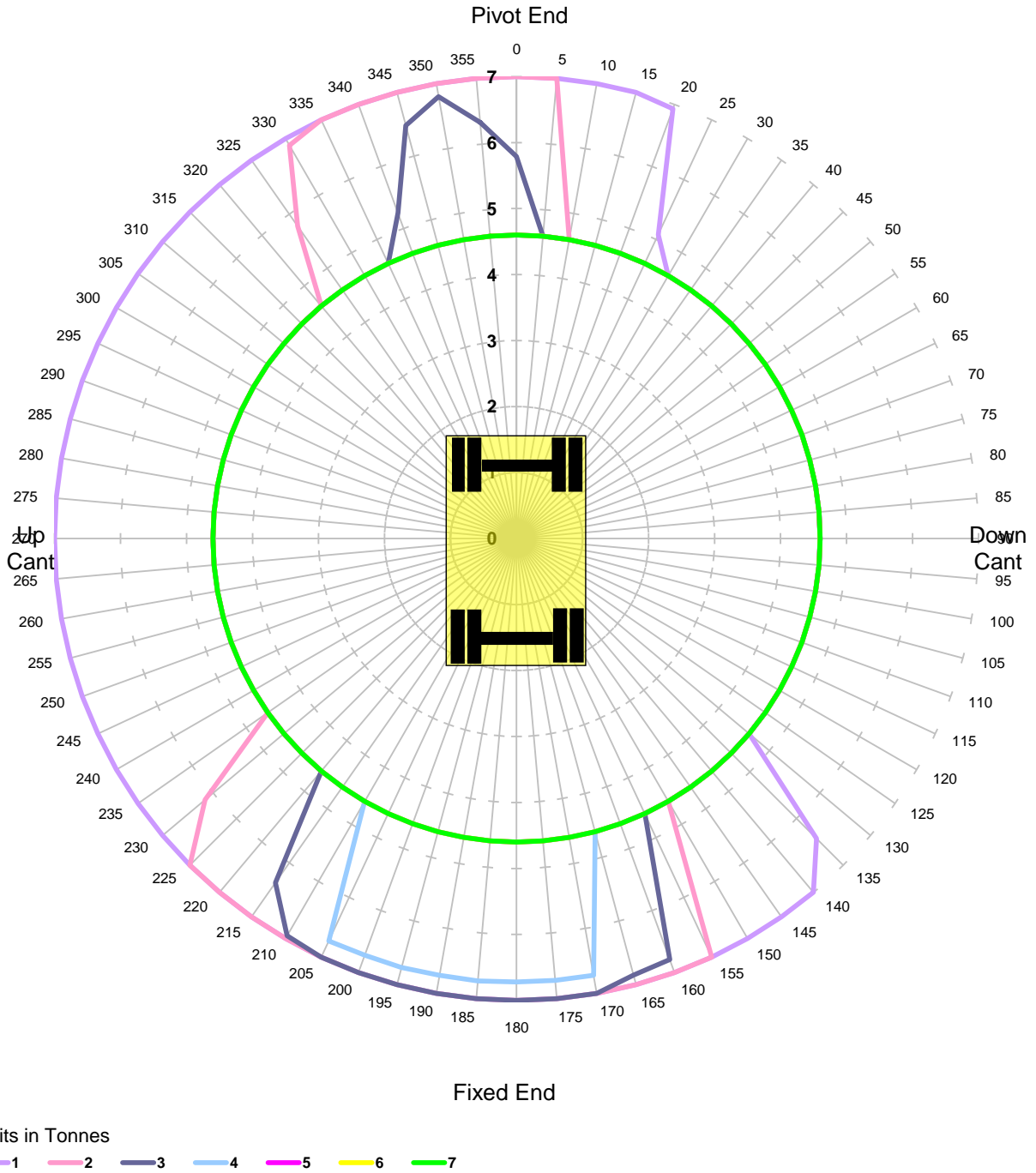

<b>MACHINE &amp; MODEL:</b>	Komatsu PW160-7	<b>REFERENCE:</b>	
<b>SERIAL No:</b>	H50093	<b>DATE OF CHART:</b>	19-Oct-2021
<b>EQUIPMENT:</b>	5.15m + 2.10m	<b>SAFETY FACTOR:</b>	67.0%
<b>COMMENT:</b>			

**Komatsu PW160-7**  
**Max Capacity Contours of Radius(m) Plots 2.1m Dipper**  
**Gradient 1 in -25 Height 2m Lift ALP1**  
**Unlocked Rail Cant -50mm**

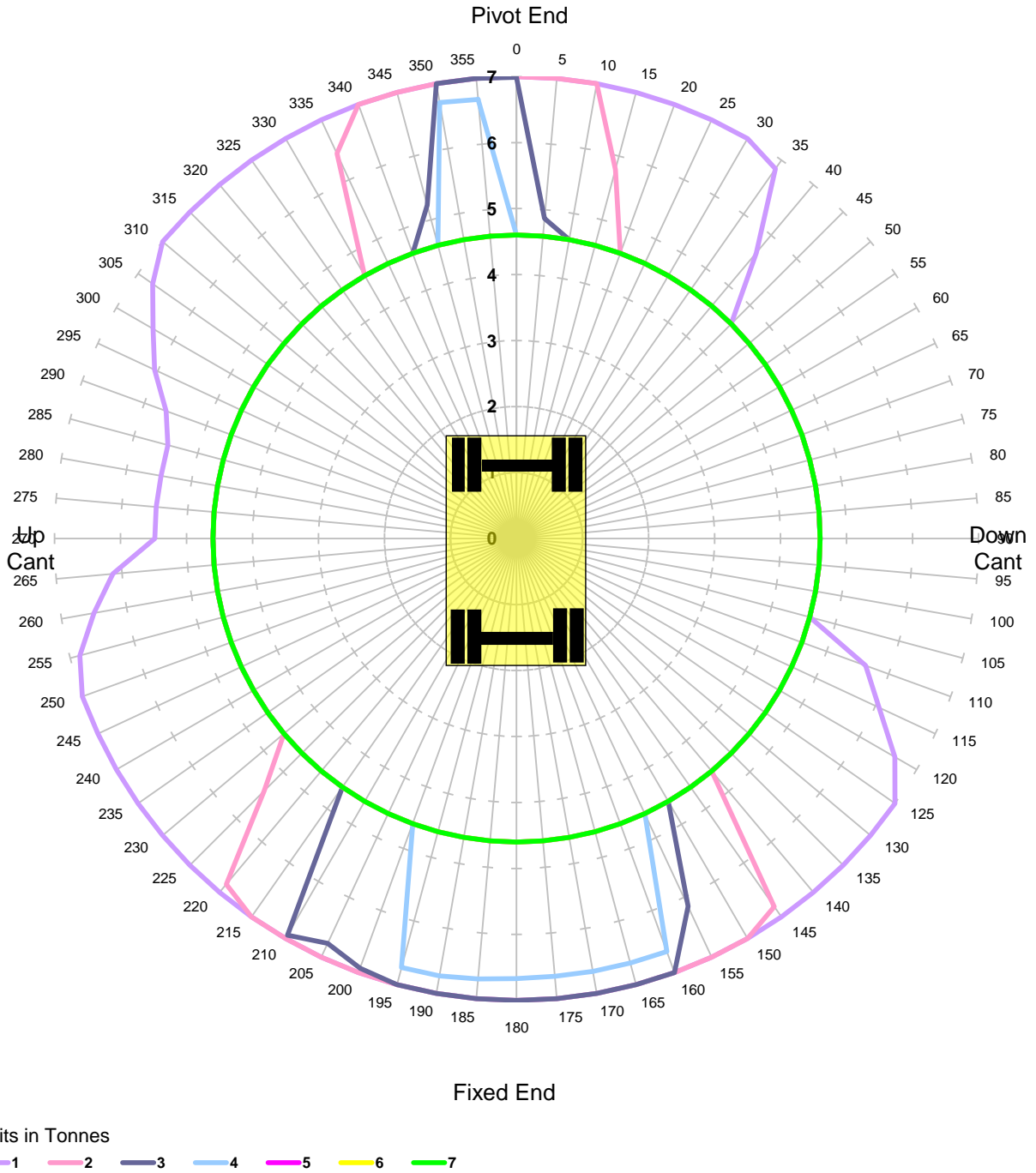

<b>MACHINE &amp; MODEL:</b>	Komatsu PW160-7	<b>REFERENCE:</b>	
<b>SERIAL No:</b>	H50093	<b>DATE OF CHART:</b>	19-Oct-2021
<b>EQUIPMENT:</b>	5.15m + 2.10m	<b>SAFETY FACTOR:</b>	67.0%
<b>COMMENT:</b>			

**Komatsu PW160-7**  
**Max Capacity Contours of Radius(m) Plots 2.1m Dipper**  
**Gradient 1 in -25 Height 2m Lift ALP1**  
**Unlocked Rail Cant 50mm**

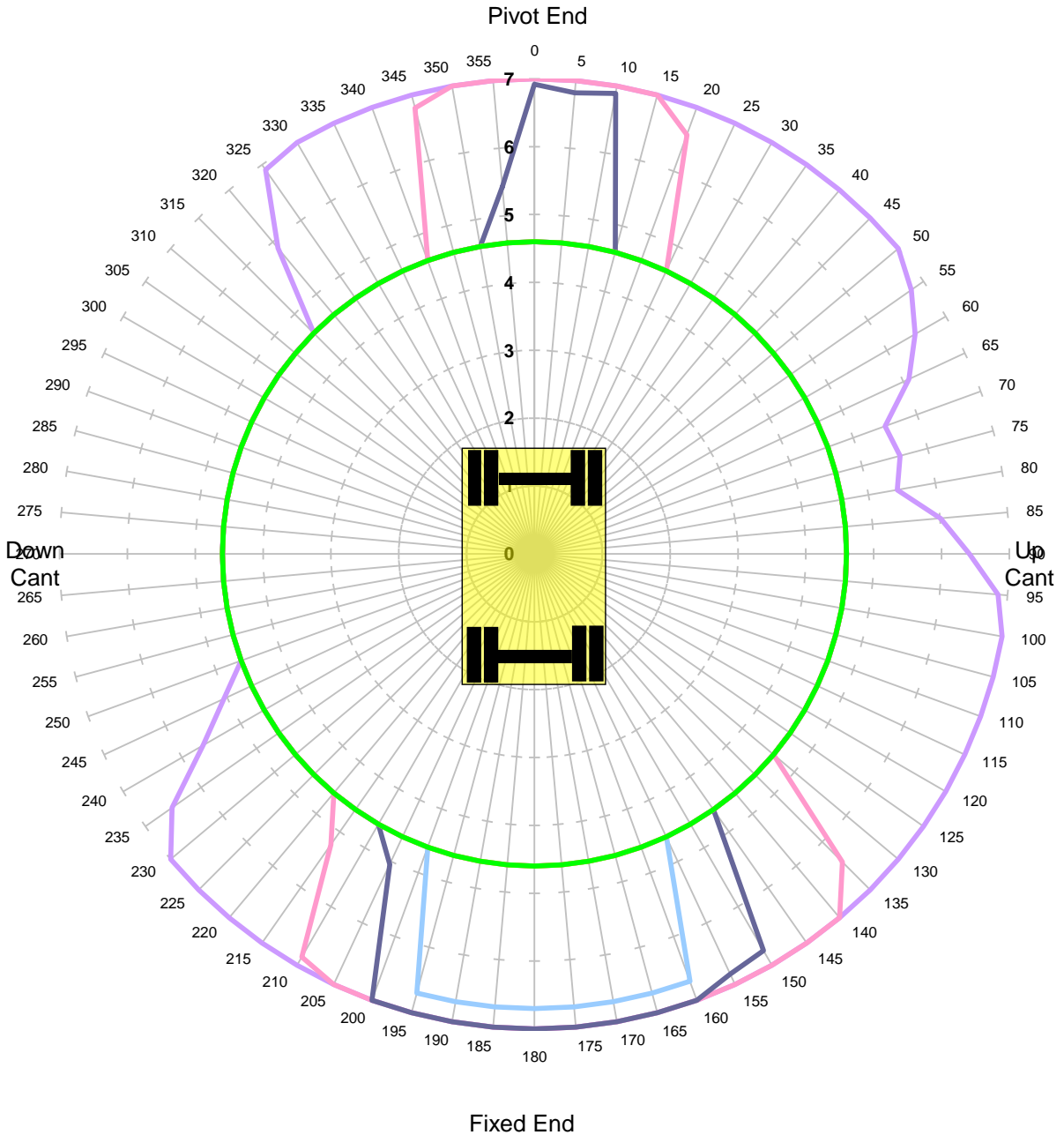

Units in Tonnes

- 1
- 2
- 3
- 4
- 5
- 6
- 7

<b>MACHINE &amp; MODEL:</b>	Komatsu PW160-7	<b>REFERENCE:</b>	
<b>SERIAL No:</b>	H50093	<b>DATE OF CHART:</b>	19-Oct-2021
<b>EQUIPMENT:</b>	5.15m + 2.10m	<b>SAFETY FACTOR:</b>	67.0%
<b>COMMENT:</b>			

**Komatsu PW160-7**  
**Max Capacity Contours of Radius(m) Plots 2.1m Dipper**  
**Gradient 1 in -25 Height 2m Lift ALP1**  
**Unlocked Rail Cant 150mm**

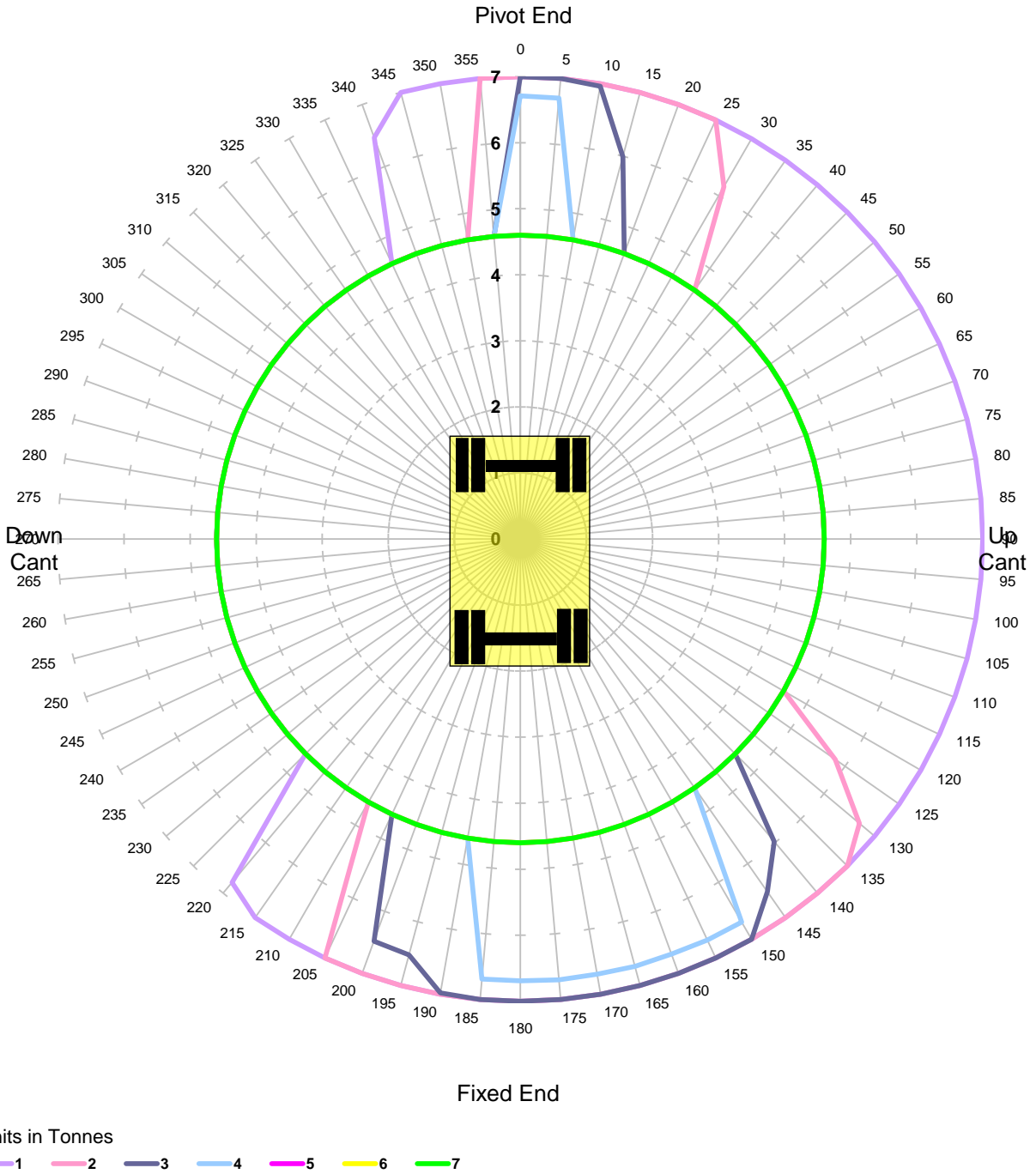

<b>MACHINE &amp; MODEL:</b>	Komatsu PW160-7	<b>REFERENCE:</b>	
<b>SERIAL No:</b>	H50093	<b>DATE OF CHART:</b>	19-Oct-2021
<b>EQUIPMENT:</b>	5.15m + 2.10m	<b>SAFETY FACTOR:</b>	67.0%
<b>COMMENT:</b>			



**Komatsu PW160-7**  
**Max Capacity Contours of Radius(m) Plots 2.1m Dipper**  
**Gradient 1 in -25 Height 2m Lift ALP1**  
**Locked Rail Cant -150mm**

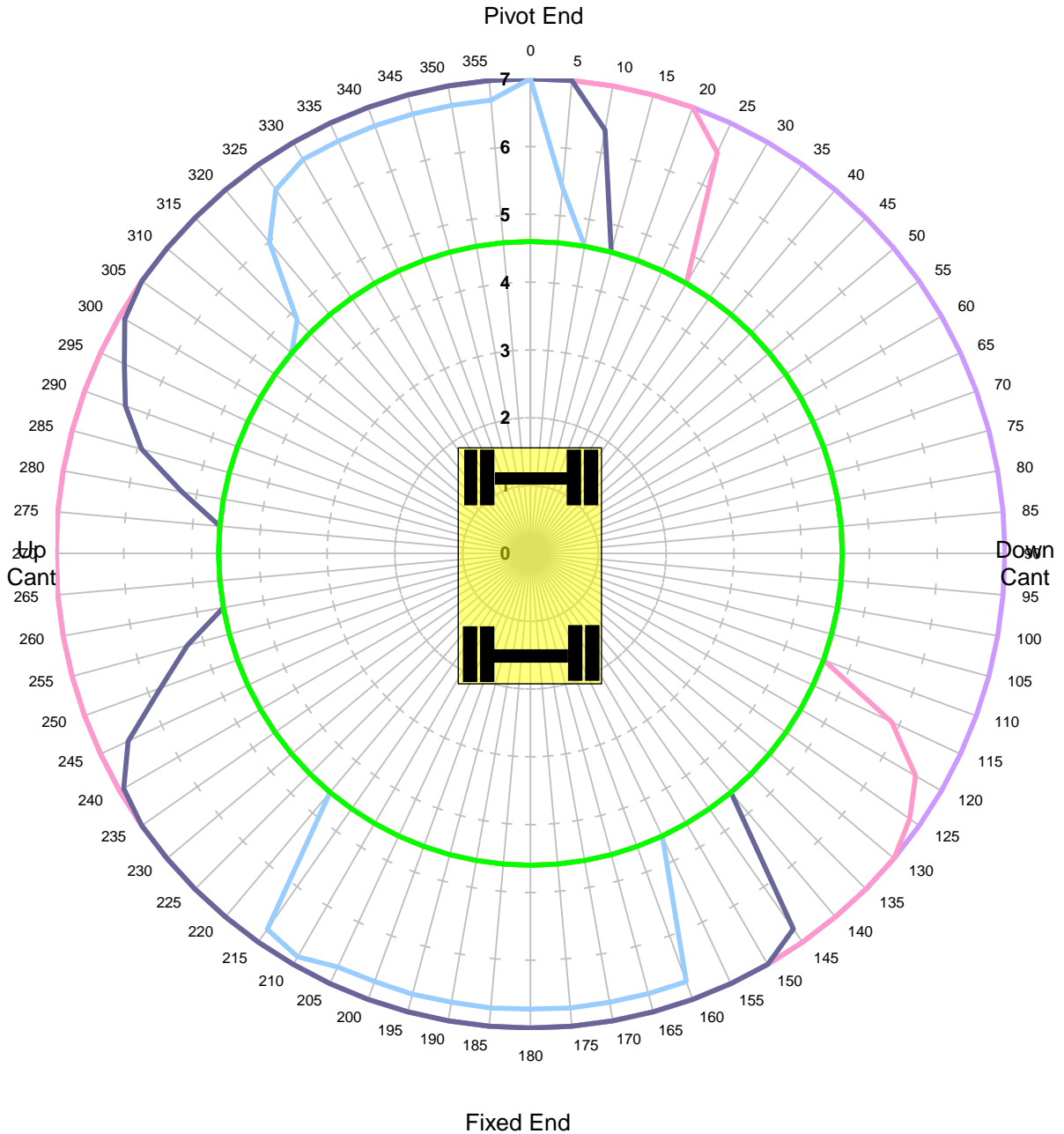

Units in Tonnes

- 1
- 2
- 3
- 4
- 5
- 6
- 7

<b>MACHINE &amp; MODEL:</b>	Komatsu PW160-7	<b>REFERENCE:</b>	
<b>SERIAL No:</b>	H50093	<b>DATE OF CHART:</b>	19-Oct-2021
<b>EQUIPMENT:</b>	5.15m + 2.10m	<b>SAFETY FACTOR:</b>	90.0%
<b>COMMENT:</b>			

**Komatsu PW160-7**  
**Max Capacity Contours of Radius(m) Plots 2.1m Dipper**  
**Gradient 1 in -25 Height 2m Lift ALP1**  
**Locked Rail Cant -50mm**

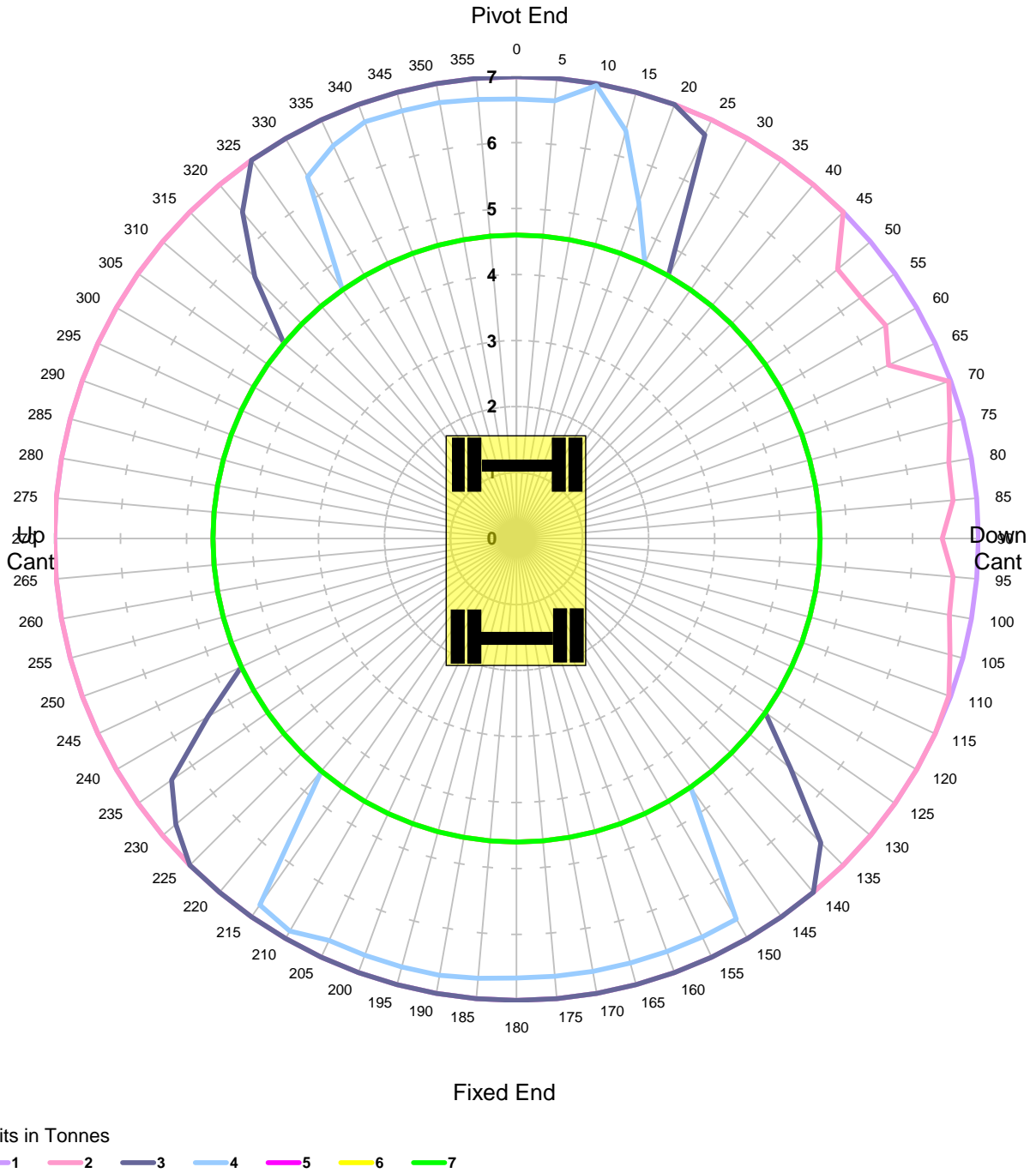

<b>MACHINE &amp; MODEL:</b>	Komatsu PW160-7	<b>REFERENCE:</b>	
<b>SERIAL No:</b>	H50093	<b>DATE OF CHART:</b>	19-Oct-2021
<b>EQUIPMENT:</b>	5.15m + 2.10m	<b>SAFETY FACTOR:</b>	90.0%
<b>COMMENT:</b>			

**Komatsu PW160-7**  
**Max Capacity Contours of Radius(m) Plots 2.1m Dipper**  
**Gradient 1 in -25 Height 2m Lift ALP1**  
**Locked Rail Cant 50mm**

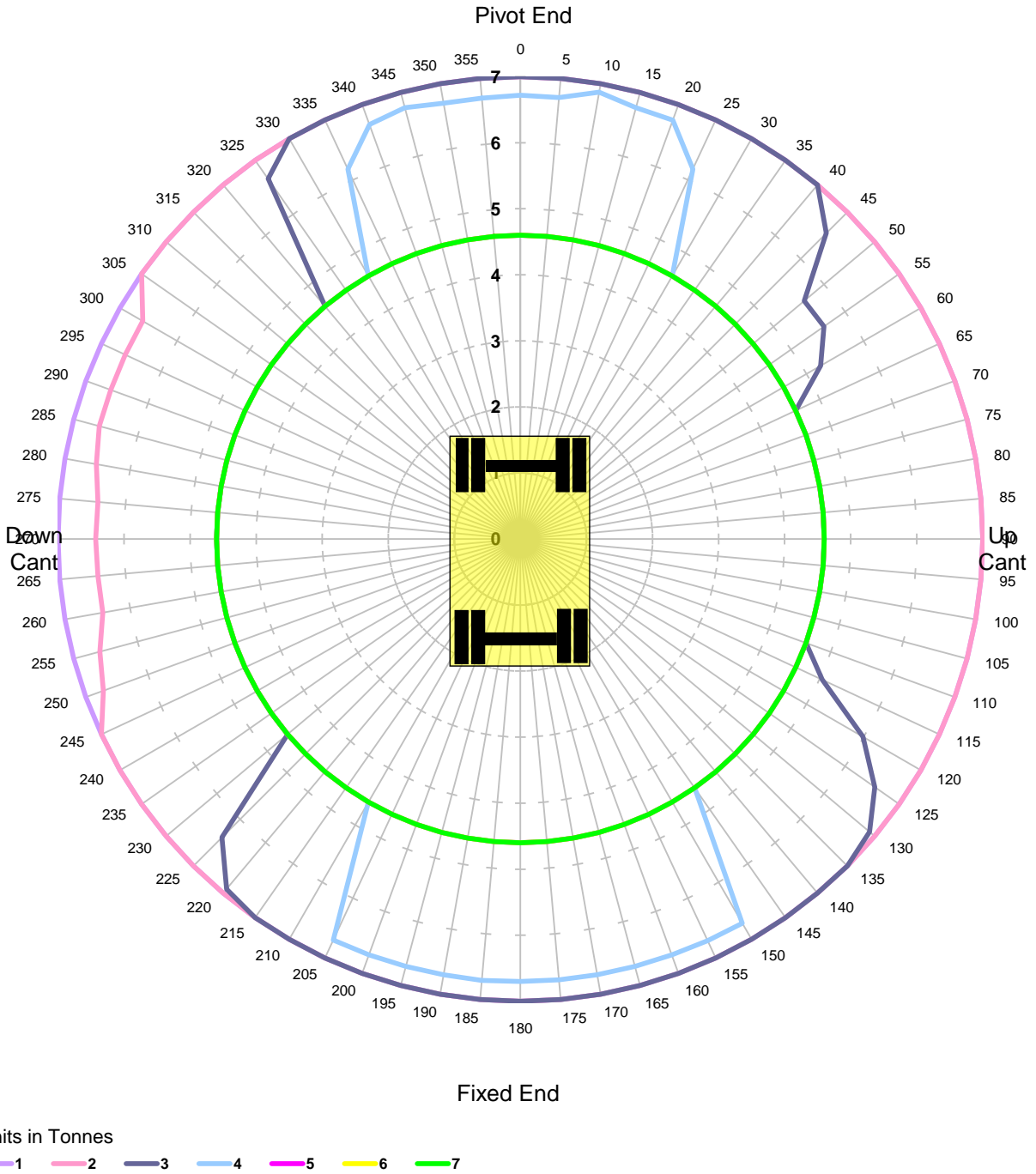

<b>MACHINE &amp; MODEL:</b>	Komatsu PW160-7	<b>REFERENCE:</b>	
<b>SERIAL No:</b>	H50093	<b>DATE OF CHART:</b>	19-Oct-2021
<b>EQUIPMENT:</b>	5.15m + 2.10m	<b>SAFETY FACTOR:</b>	90.0%
<b>COMMENT:</b>			

**Komatsu PW160-7**  
**Max Capacity Contours of Radius(m) Plots 2.1m Dipper**  
**Gradient 1 in -25 Height 2m Lift ALP1**  
**Locked Rail Cant 150mm**

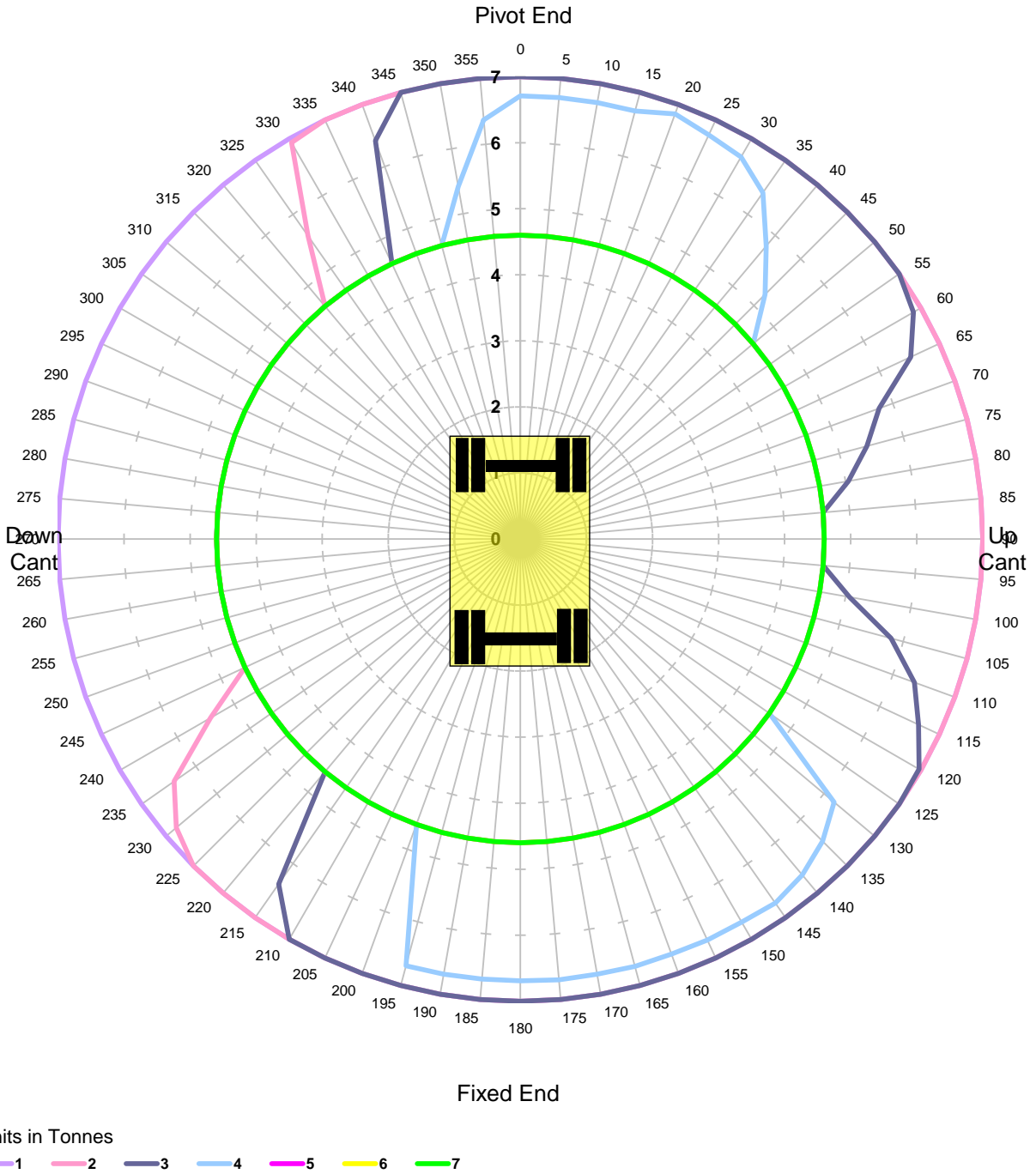

<b>MACHINE &amp; MODEL:</b>	Komatsu PW160-7	<b>REFERENCE:</b>	
<b>SERIAL No:</b>	H50093	<b>DATE OF CHART:</b>	19-Oct-2021
<b>EQUIPMENT:</b>	5.15m + 2.10m	<b>SAFETY FACTOR:</b>	90.0%
<b>COMMENT:</b>			

**Komatsu PW160-7**  
**Max Capacity Contours of Radius(m) Plots 2.1m Dipper**  
**Level Ground Height 2m Lift ALP1**  
**Unlocked Road**

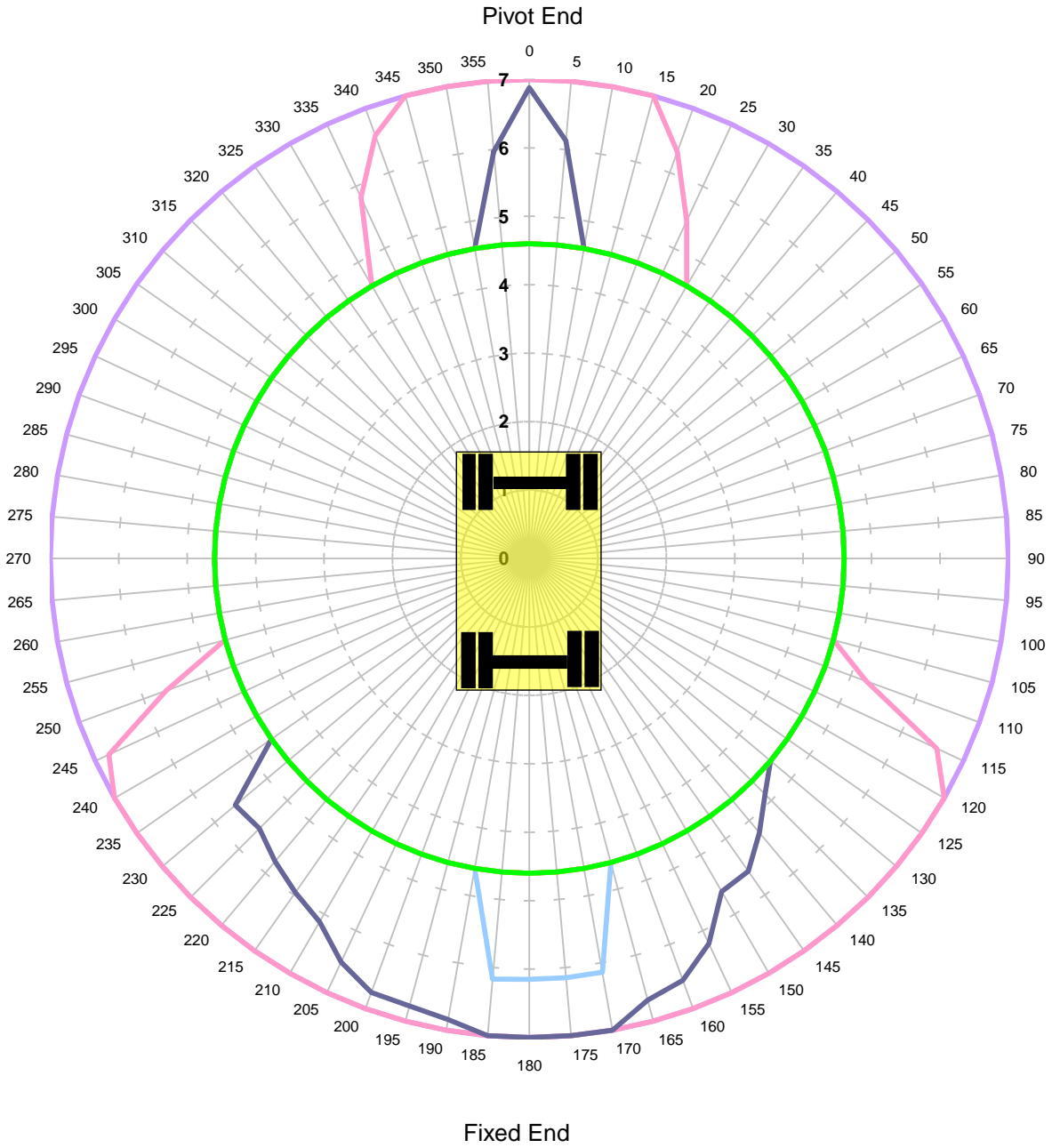

Units in Tonnes

- 1
- 2
- 3
- 4
- 5
- 6
- 7

<b>MACHINE &amp; MODEL:</b>	Komatsu PW160-7	<b>REFERENCE:</b>	
<b>SERIAL No:</b>	H50093	<b>DATE OF CHART:</b>	19-Oct-2021
<b>EQUIPMENT:</b>	5.15m + 2.10m	<b>SAFETY FACTOR:</b>	71.0%
<b>COMMENT:</b>			

**Komatsu PW160-7**  
**Max Capacity Contours of Radius(m) Plots 2.1m Dipper**  
**Level Ground Height 2m Lift ALP1**  
**Locked Road**

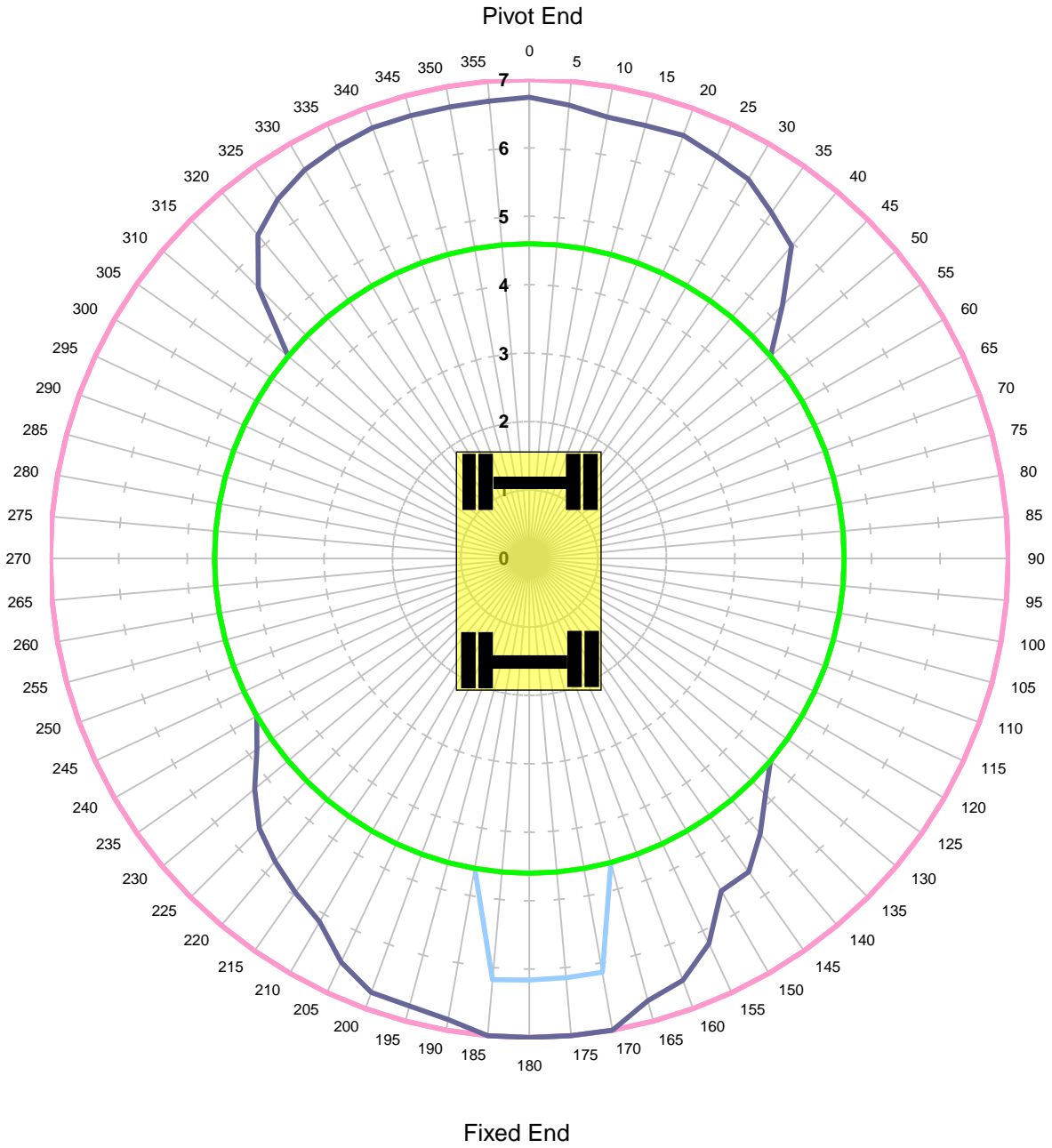

Units in Tonnes

- 1
- 2
- 3
- 4
- 5
- 6
- 7

<b>MACHINE &amp; MODEL:</b>	Komatsu PW160-7	<b>REFERENCE:</b>	
<b>SERIAL No:</b>	H50093	<b>DATE OF CHART:</b>	19-Oct-2021
<b>EQUIPMENT:</b>	5.15m + 2.10m	<b>SAFETY FACTOR:</b>	71.0%
<b>COMMENT:</b>			

**Komatsu PW160-7**  
**Max Capacity Contours of Radius(m) Plots 2.1m Dipper**  
**Gradient 1 in -25 Height 2m Lift ALP1**  
**Unlocked Rail Cant -150mm - Tandem Lift**

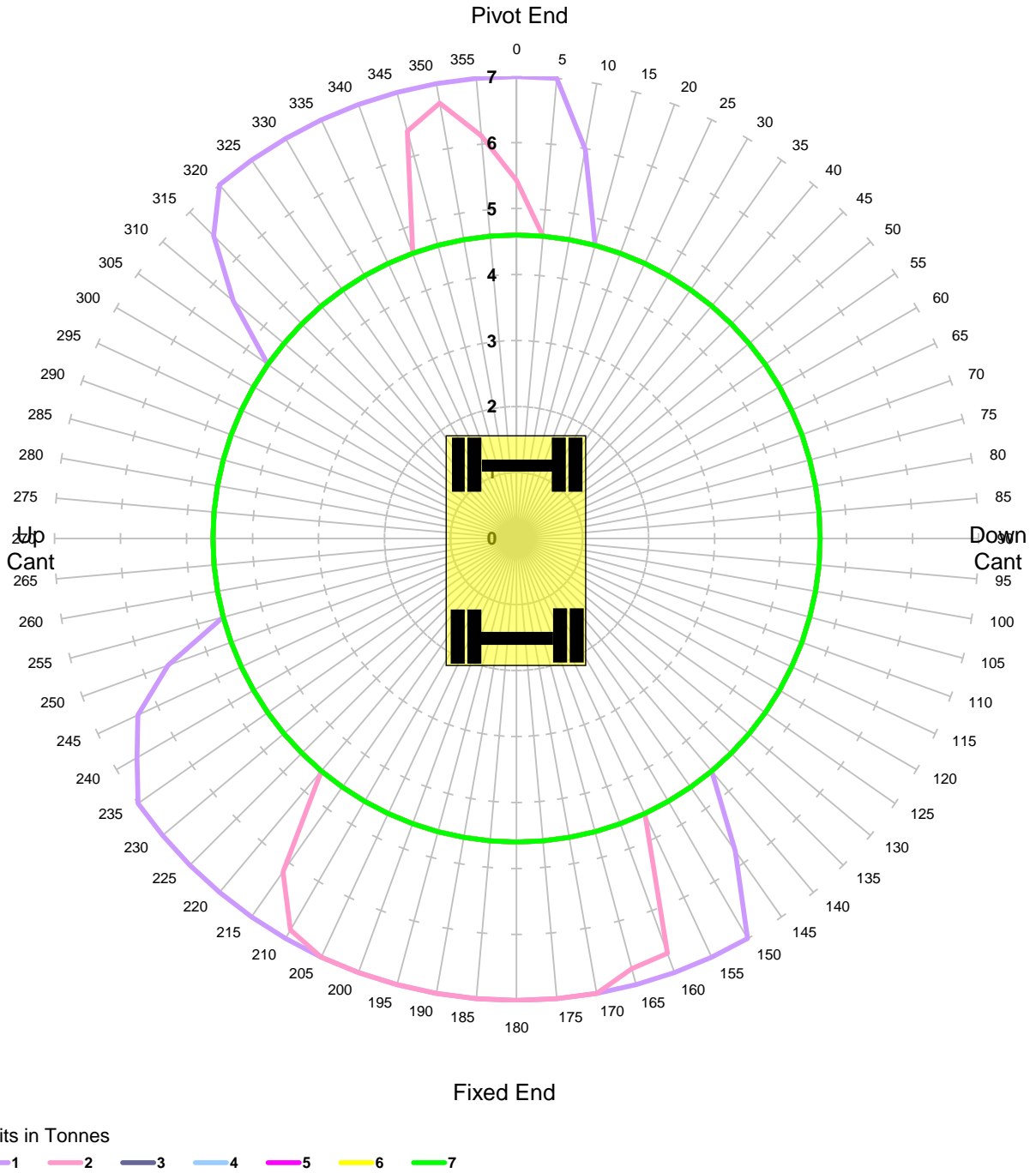

<b>MACHINE &amp; MODEL:</b>	Komatsu PW160-7	<b>REFERENCE:</b>	
<b>SERIAL No:</b>	H50093	<b>DATE OF CHART:</b>	19-Oct-2021
<b>EQUIPMENT:</b>	5.15m + 2.10m	<b>SAFETY FACTOR:</b>	44.0%
<b>COMMENT:</b>			

**Komatsu PW160-7**  
**Max Capacity Contours of Radius(m) Plots 2.1m Dipper**  
**Gradient 1 in -25 Height 2m Lift ALP1**  
**Unlocked Rail Cant -50mm - Tandem Lift**

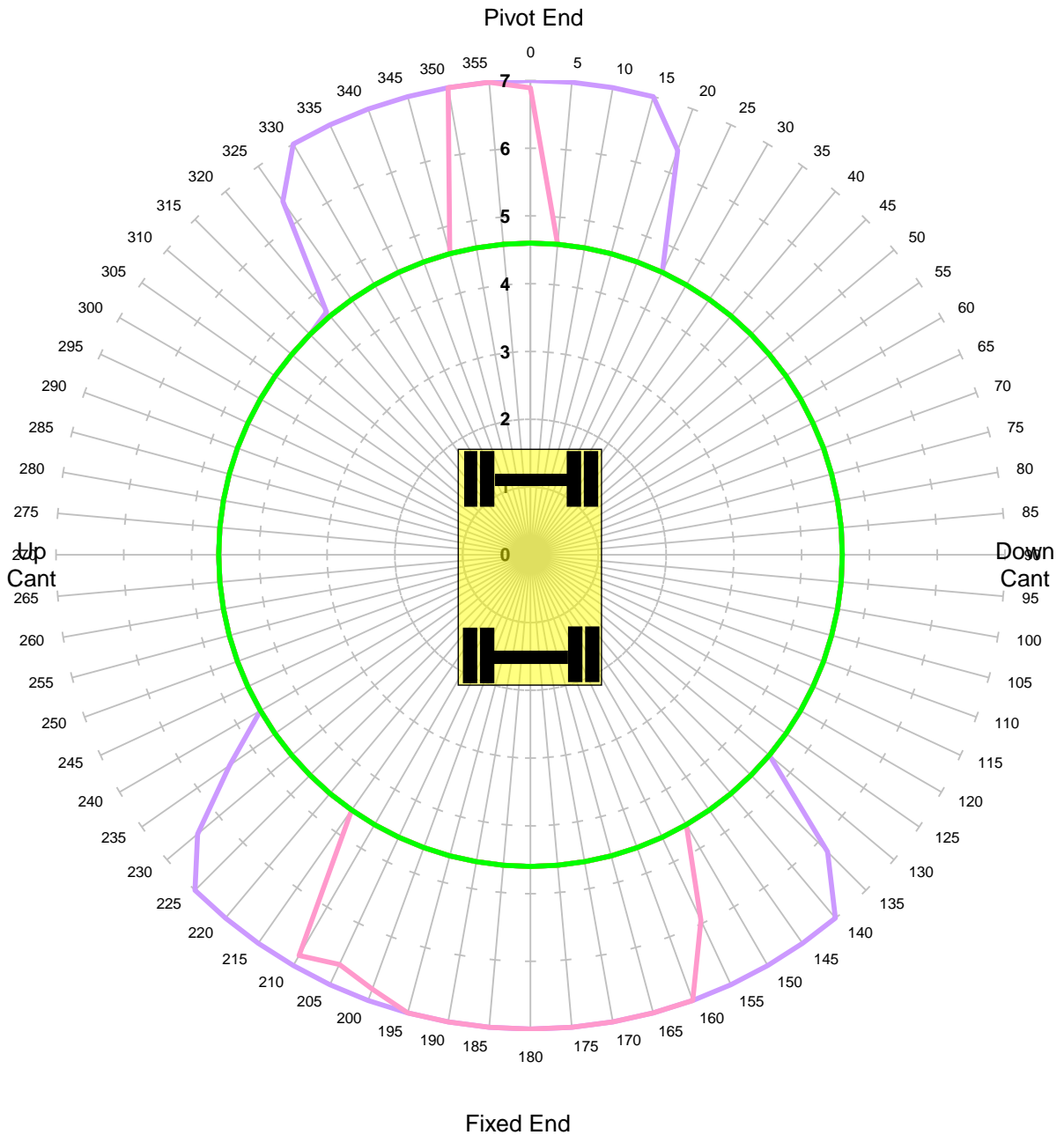

Units in Tonnes



<b>MACHINE &amp; MODEL:</b>	Komatsu PW160-7	<b>REFERENCE:</b>	
<b>SERIAL No:</b>	H50093	<b>DATE OF CHART:</b>	19-Oct-2021
<b>EQUIPMENT:</b>	5.15m + 2.10m	<b>SAFETY FACTOR:</b>	44.0%
<b>COMMENT:</b>			



**Komatsu PW160-7**  
**Max Capacity Contours of Radius(m) Plots 2.1m Dipper**  
**Gradient 1 in -25 Height 2m Lift ALP1**  
**Unlocked Rail Cant 50mm - Tandem Lift**

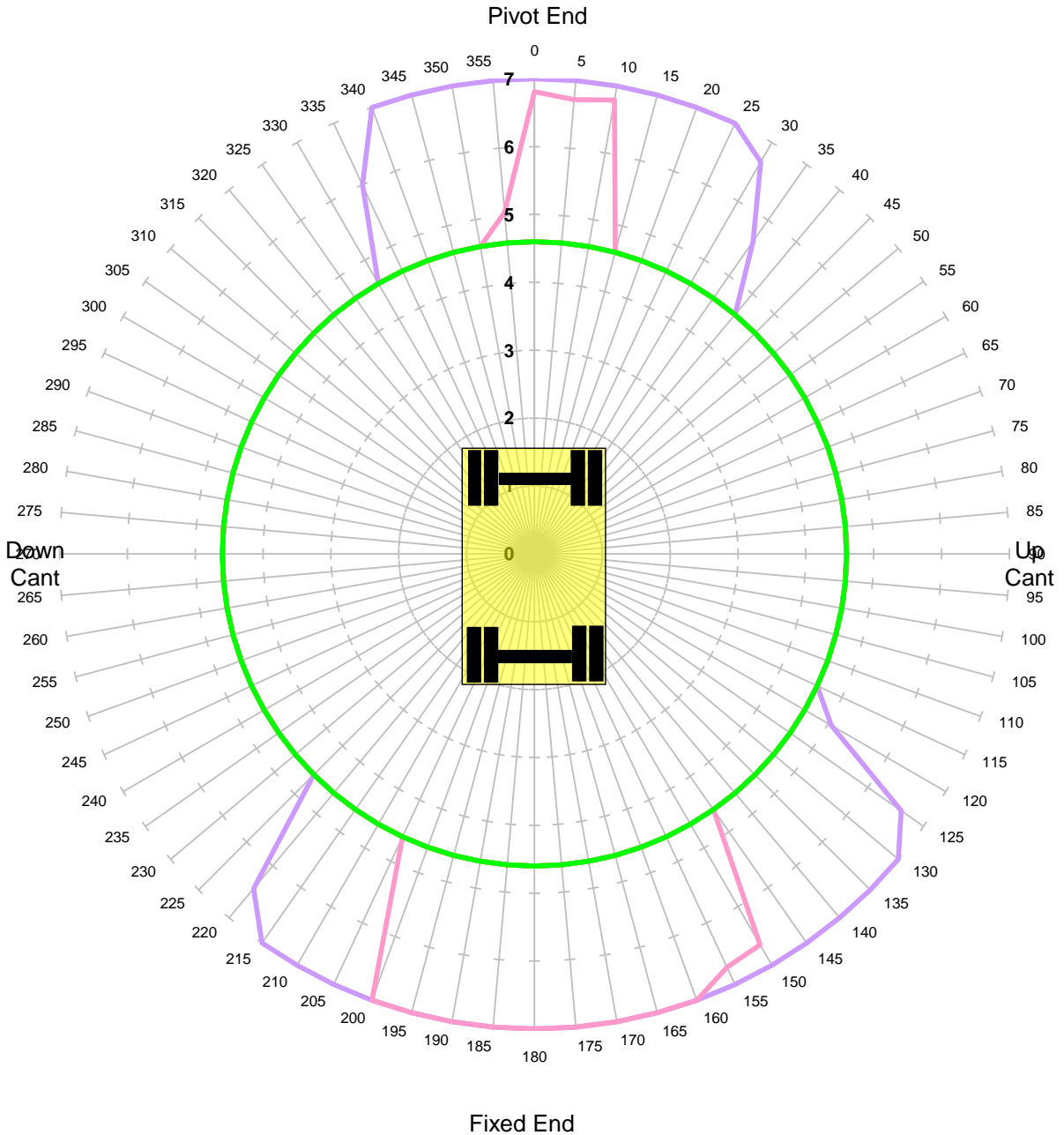

Units in Tonnes



<b>MACHINE &amp; MODEL:</b>	Komatsu PW160-7	<b>REFERENCE:</b>	
<b>SERIAL No:</b>	H50093	<b>DATE OF CHART:</b>	19-Oct-2021
<b>EQUIPMENT:</b>	5.15m + 2.10m	<b>SAFETY FACTOR:</b>	44.0%
<b>COMMENT:</b>			

**Komatsu PW160-7**  
**Max Capacity Contours of Radius(m) Plots 2.1m Dipper**  
**Gradient 1 in -25 Height 2m Lift ALP1**  
**Unlocked Rail Cant 150mm - Tandem Lift**

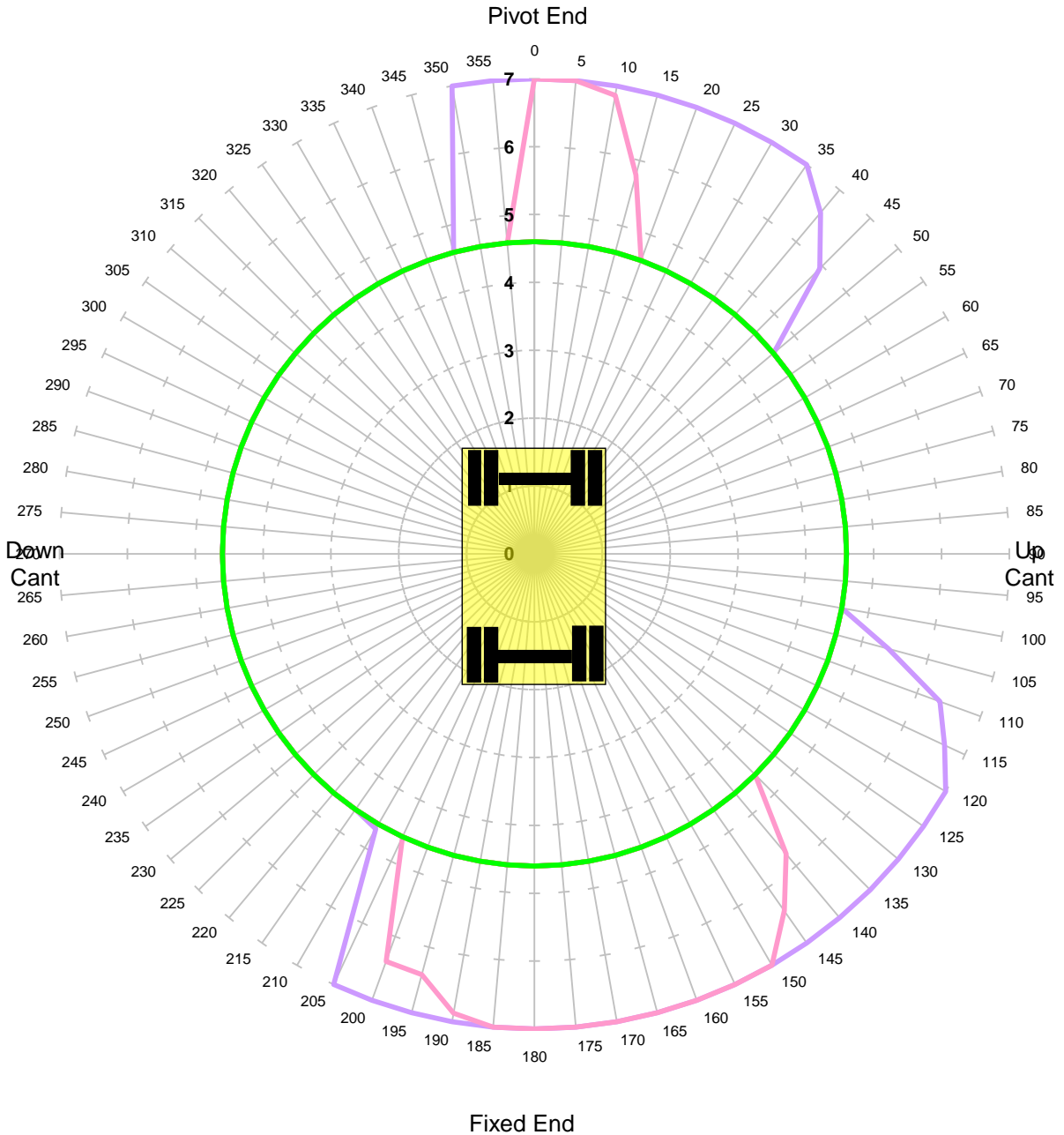

Units in Tonnes



<b>MACHINE &amp; MODEL:</b>	Komatsu PW160-7	<b>REFERENCE:</b>	
<b>SERIAL No:</b>	H50093	<b>DATE OF CHART:</b>	19-Oct-2021
<b>EQUIPMENT:</b>	5.15m + 2.10m	<b>SAFETY FACTOR:</b>	44.0%
<b>COMMENT:</b>			

**Komatsu PW160-7**  
**Max Capacity Contours of Radius(m) Plots 2.1m Dipper**  
**Gradient 1 in -25 Height 2m Lift ALP1**  
**Locked Rail Cant -150mm - Tandem Lift**

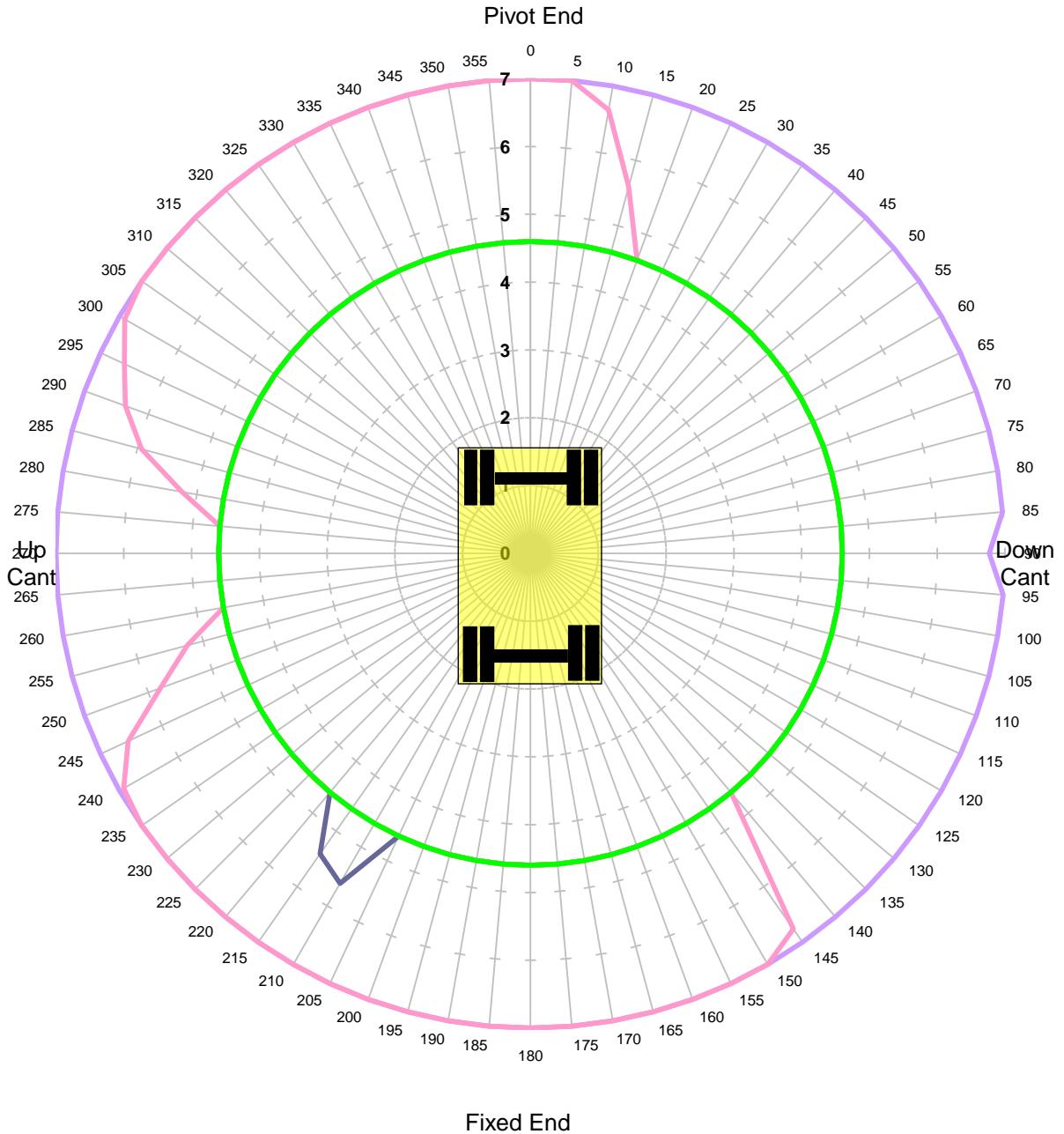

Units in Tonnes

- 1
- 2
- 3
- 4
- 5
- 6
- 7

<b>MACHINE &amp; MODEL:</b>	Komatsu PW160-7	<b>REFERENCE:</b>	
<b>SERIAL No:</b>	H50093	<b>DATE OF CHART:</b>	19-Oct-2021
<b>EQUIPMENT:</b>	5.15m + 2.10m	<b>SAFETY FACTOR:</b>	59.0%
<b>COMMENT:</b>			

**Komatsu PW160-7**  
**Max Capacity Contours of Radius(m) Plots 2.1m Dipper**  
**Gradient 1 in -25 Height 2m Lift ALP1**  
**Locked Rail Cant -50mm - Tandem Lift**

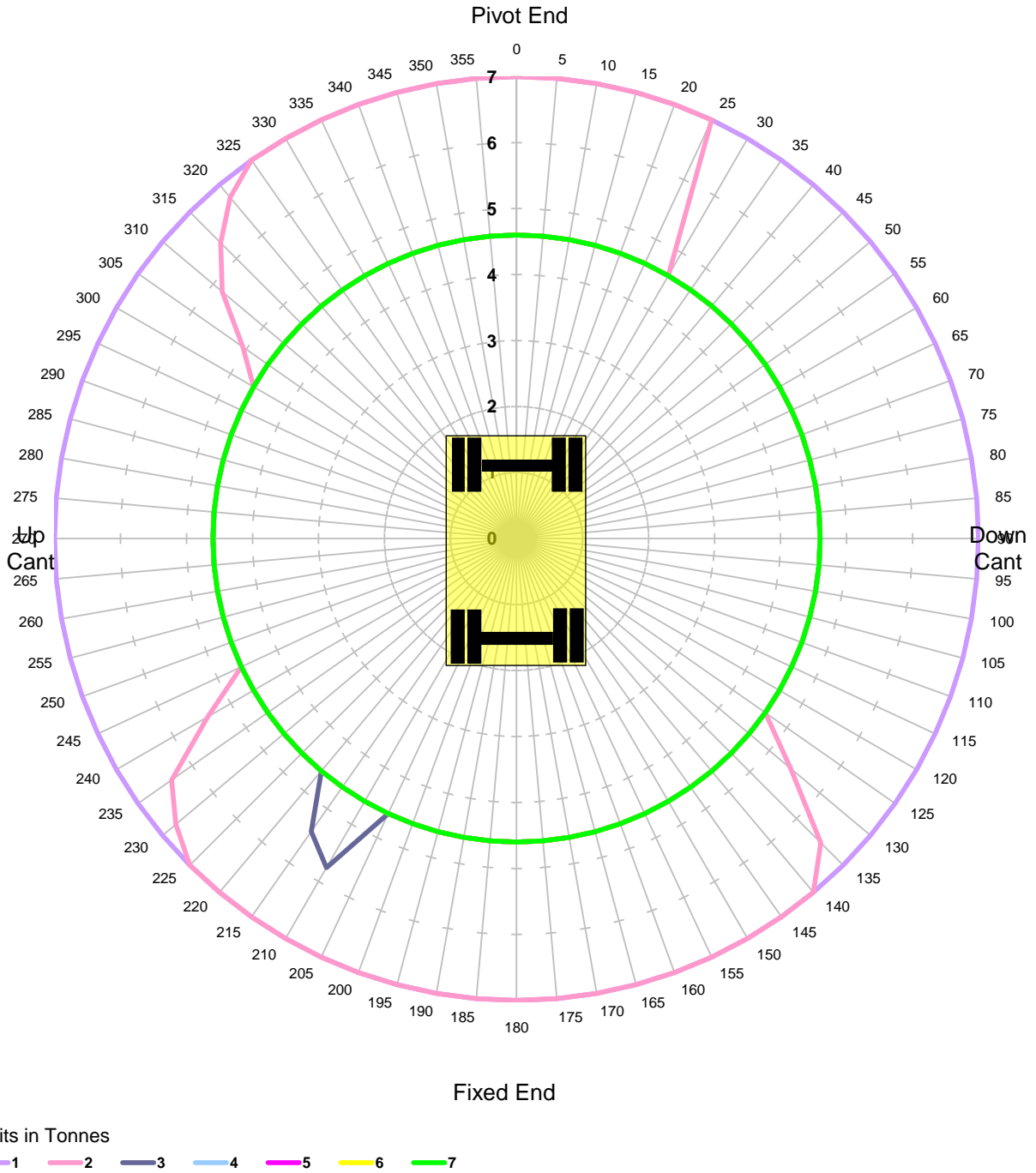

<b>MACHINE &amp; MODEL:</b>	Komatsu PW160-7	<b>REFERENCE:</b>	
<b>SERIAL No:</b>	H50093	<b>DATE OF CHART:</b>	19-Oct-2021
<b>EQUIPMENT:</b>	5.15m + 2.10m	<b>SAFETY FACTOR:</b>	59.0%
<b>COMMENT:</b>			

**Komatsu PW160-7**  
**Max Capacity Contours of Radius(m) Plots 2.1m Dipper**  
**Gradient 1 in -25 Height 2m Lift ALP1**  
**Locked Rail Cant 50mm - Tandem Lift**

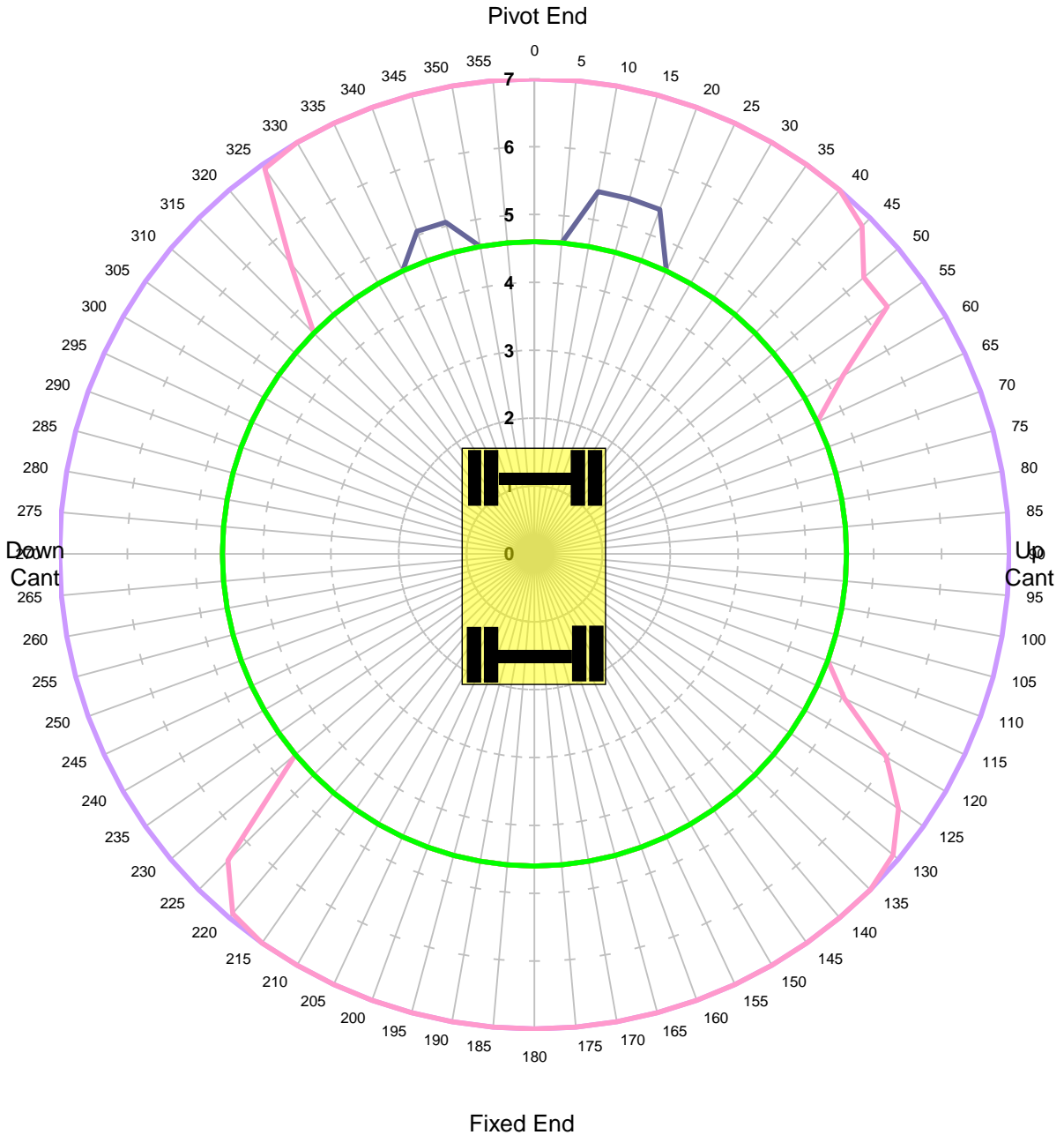

Units in Tonnes



<b>MACHINE &amp; MODEL:</b>	Komatsu PW160-7	<b>REFERENCE:</b>	
<b>SERIAL No:</b>	H50093	<b>DATE OF CHART:</b>	19-Oct-2021
<b>EQUIPMENT:</b>	5.15m + 2.10m	<b>SAFETY FACTOR:</b>	59.0%
<b>COMMENT:</b>			

**Komatsu PW160-7**  
**Max Capacity Contours of Radius(m) Plots 2.1m Dipper**  
**Gradient 1 in -25 Height 2m Lift ALP1**  
**Locked Rail Cant 150mm - Tandem Lift**

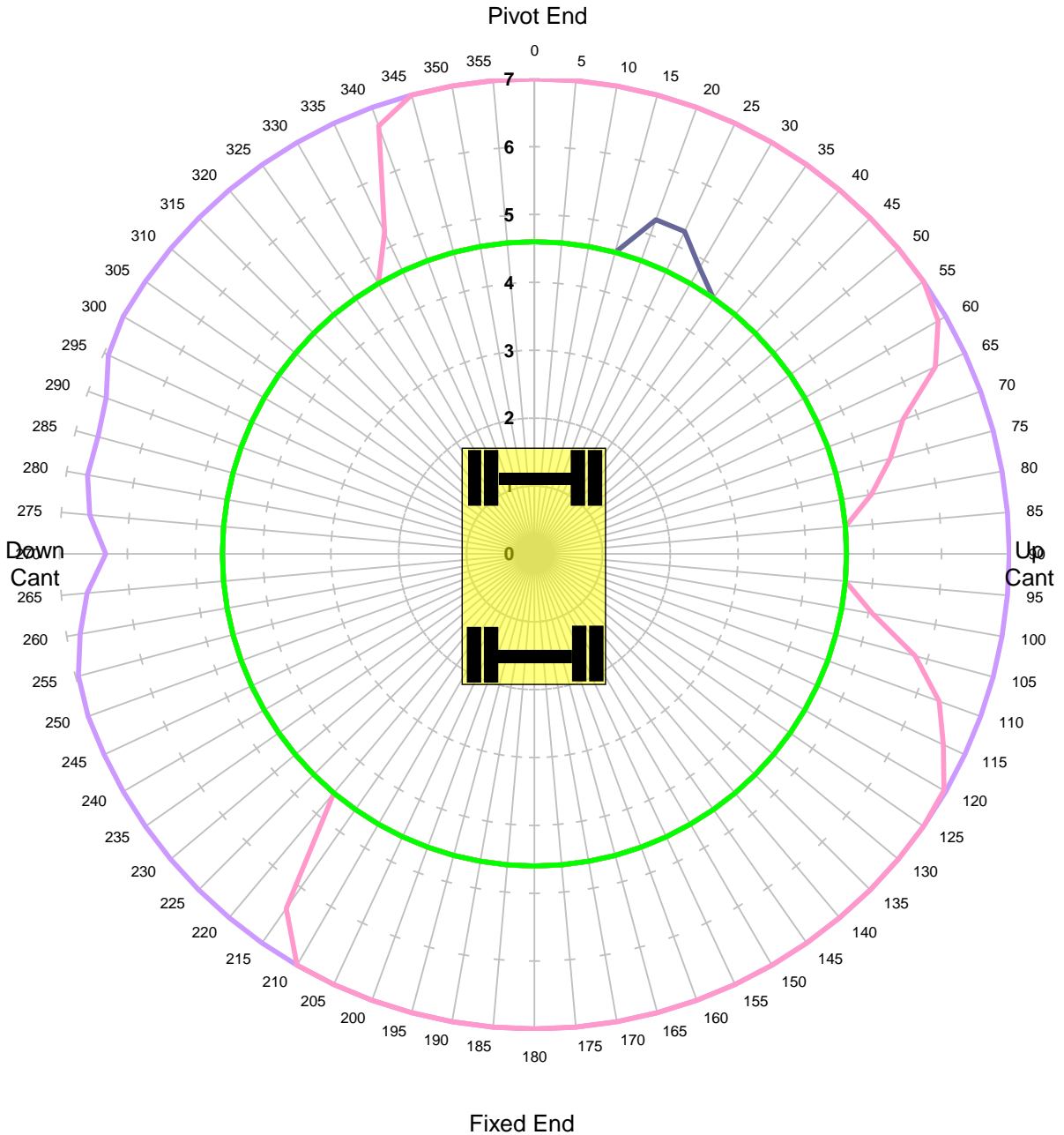

Units in Tonnes

- 1
- 2
- 3
- 4
- 5
- 6
- 7

<b>MACHINE &amp; MODEL:</b>	Komatsu PW160-7	<b>REFERENCE:</b>	
<b>SERIAL No:</b>	H50093	<b>DATE OF CHART:</b>	19-Oct-2021
<b>EQUIPMENT:</b>	5.15m + 2.10m	<b>SAFETY FACTOR:</b>	59.0%
<b>COMMENT:</b>			

**Komatsu PW160-7**  
**Max Capacity Contours of Radius(m) Plots 2.1m Dipper**  
**Level Ground Height 2m Lift ALP1**  
**Unlocked Road - Tandem Lift**

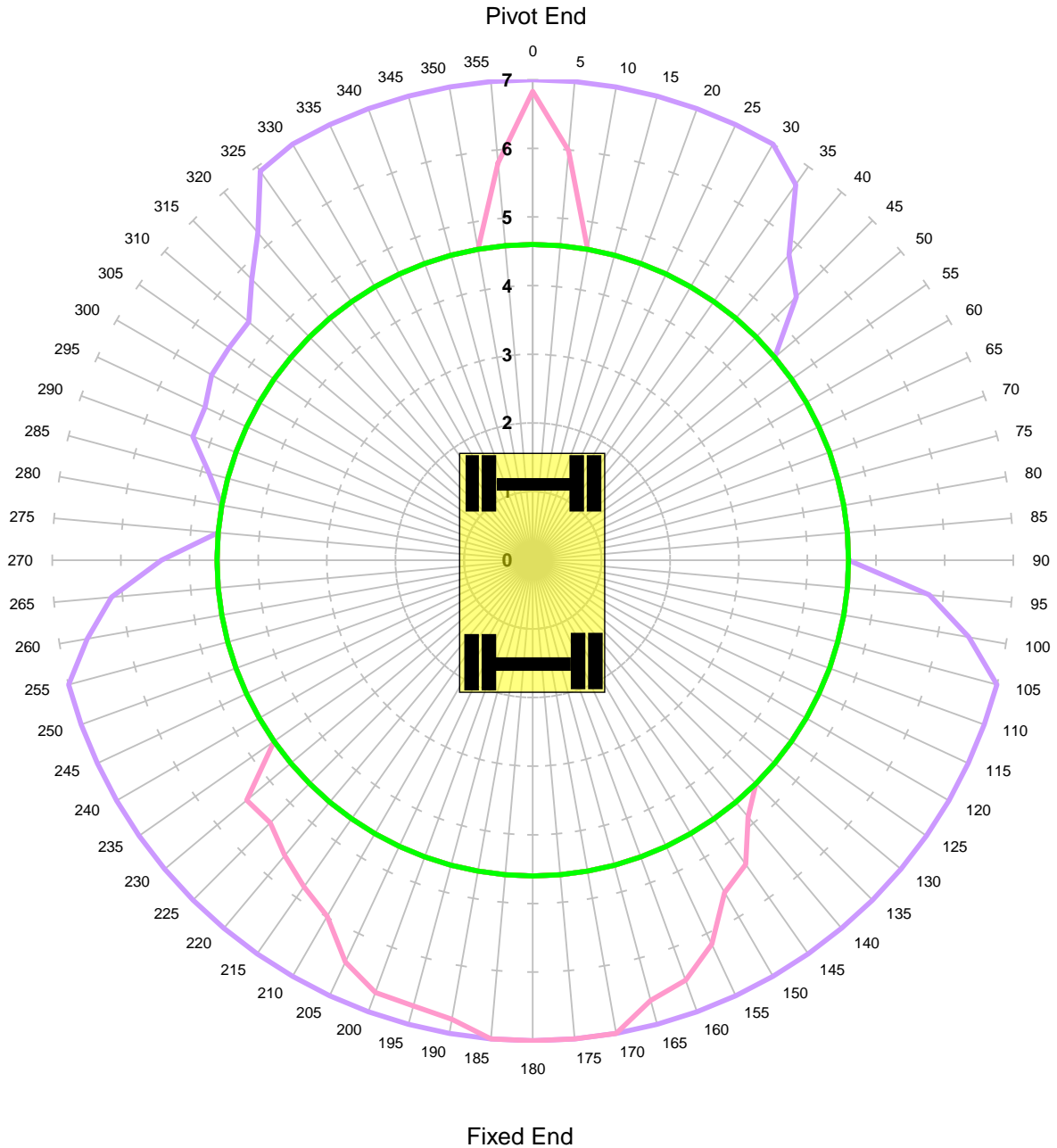

Units in Tonnes



<b>MACHINE &amp; MODEL:</b>	Komatsu PW160-7	<b>REFERENCE:</b>	
<b>SERIAL No:</b>	H50093	<b>DATE OF CHART:</b>	19-Oct-2021
<b>EQUIPMENT:</b>	5.15m + 2.10m	<b>SAFETY FACTOR:</b>	47.0%
<b>COMMENT:</b>			

**Komatsu PW160-7**  
**Max Capacity Contours of Radius(m) Plots 2.1m Dipper**  
**Level Ground Height 2m Lift ALP1**  
**Locked Road - Tandem Lift**

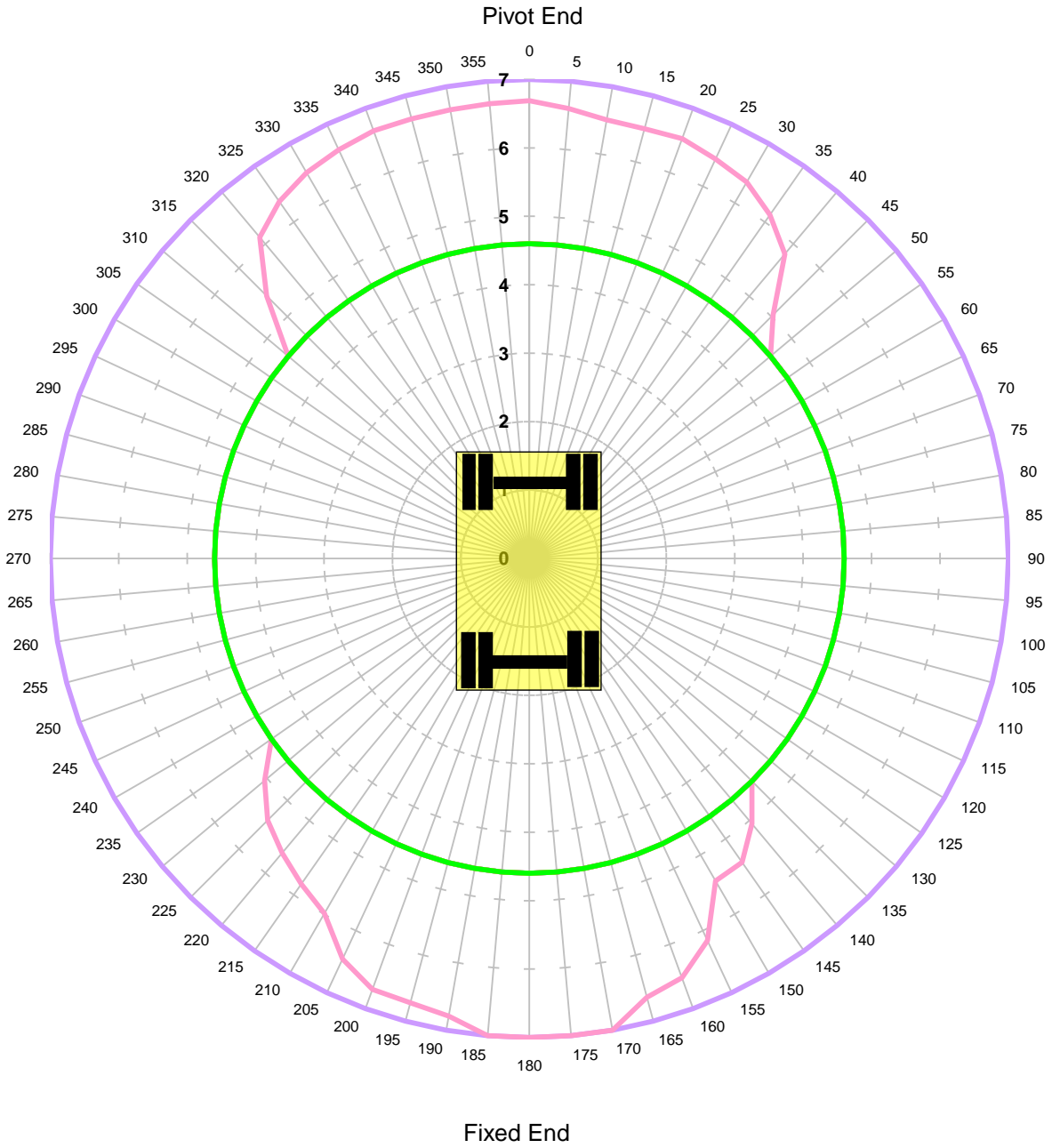

Units in Tonnes

- 1
- 2
- 3
- 4
- 5
- 6
- 7

<b>MACHINE &amp; MODEL:</b>	Komatsu PW160-7	<b>REFERENCE:</b>	
<b>SERIAL No:</b>	H50093	<b>DATE OF CHART:</b>	19-Oct-2021
<b>EQUIPMENT:</b>	5.15m + 2.10m	<b>SAFETY FACTOR:</b>	47.0%
<b>COMMENT:</b>			



**Komatsu PW160-7**  
**Max Capacity Contours of Radius(m) Plots 2.1m Dipper**  
**Gradient 1 in -25 Height 2m Lift QH**  
**Unlocked Rail Cant -150mm**

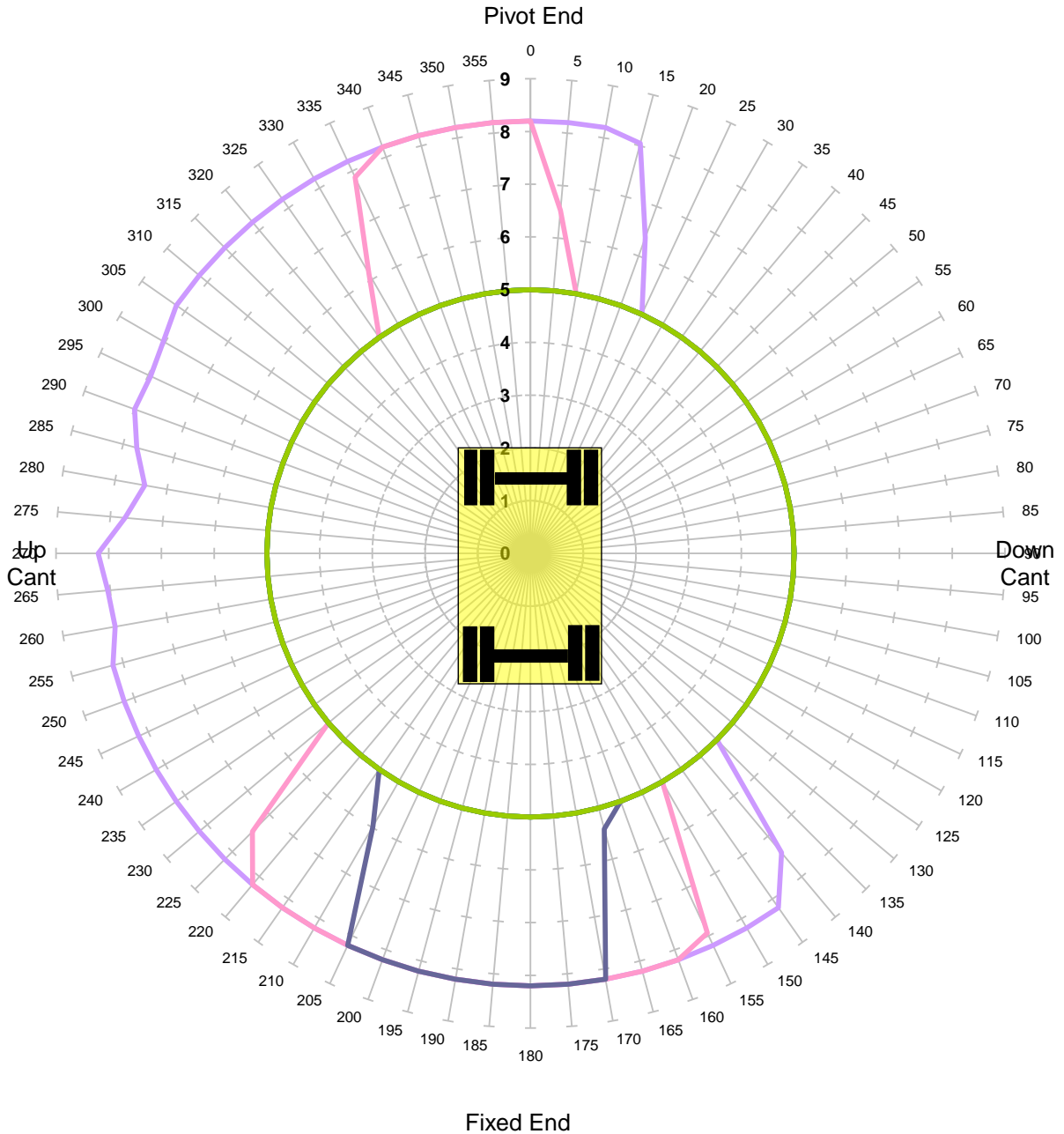

Units in Tonnes

- 1
- 2
- 3
- 4
- 5
- 6
- 7
- 8
- 9
- 10

<b>MACHINE &amp; MODEL:</b>	Komatsu PW160-7	<b>REFERENCE:</b>	
<b>SERIAL No:</b>	H50093	<b>DATE OF CHART:</b>	19-Oct-2021
<b>EQUIPMENT:</b>	5.15m + 2.10m	<b>SAFETY FACTOR:</b>	67.0%
<b>COMMENT:</b>			

**Komatsu PW160-7**  
**Max Capacity Contours of Radius(m) Plots 2.1m Dipper**  
**Gradient 1 in -25 Height 2m Lift QH**  
**Unlocked Rail Cant -50mm**

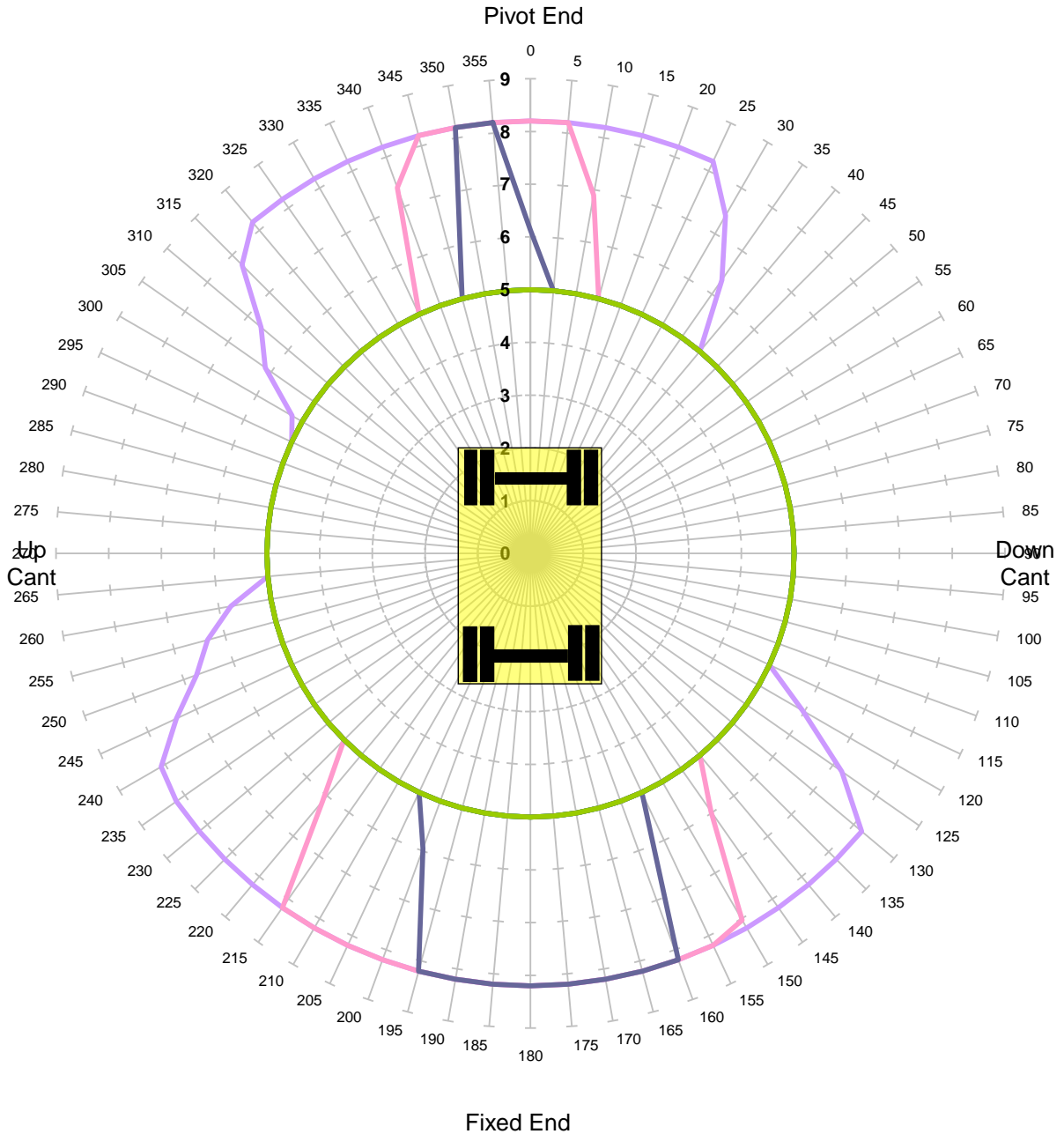

Units in Tonnes

- 1
- 2
- 3
- 4
- 5
- 6
- 7
- 8
- 9
- 10

<b>MACHINE &amp; MODEL:</b>	Komatsu PW160-7	<b>REFERENCE:</b>	
<b>SERIAL No:</b>	H50093	<b>DATE OF CHART:</b>	19-Oct-2021
<b>EQUIPMENT:</b>	5.15m + 2.10m	<b>SAFETY FACTOR:</b>	67.0%
<b>COMMENT:</b>			

**Komatsu PW160-7**  
**Max Capacity Contours of Radius(m) Plots 2.1m Dipper**  
**Gradient 1 in -25 Height 2m Lift QH**  
**Unlocked Rail Cant 50mm**

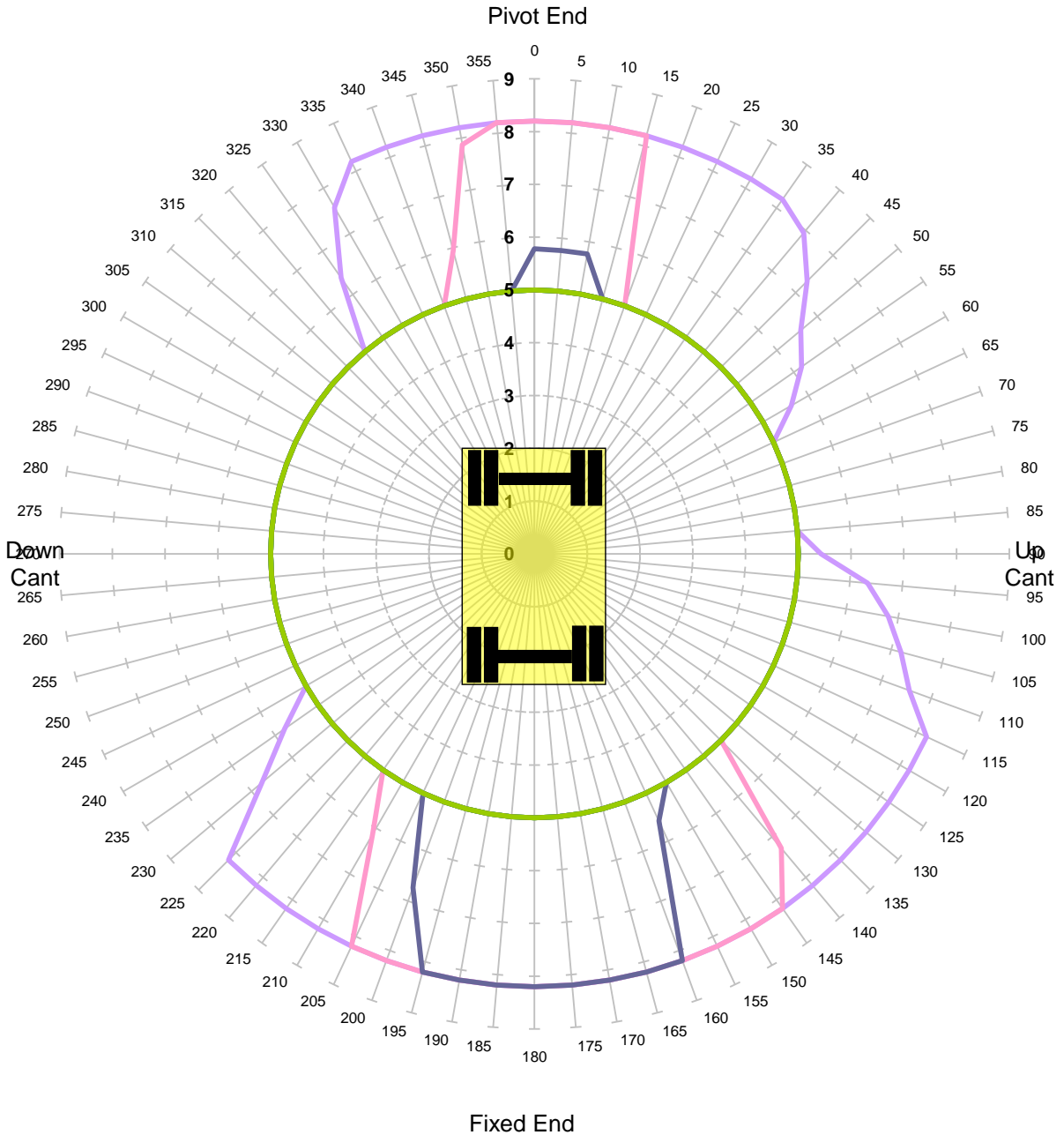

Units in Tonnes

- 1
- 2
- 3
- 4
- 5
- 6
- 7
- 8
- 9
- 10

<b>MACHINE &amp; MODEL:</b>	Komatsu PW160-7	<b>REFERENCE:</b>	
<b>SERIAL No:</b>	H50093	<b>DATE OF CHART:</b>	19-Oct-2021
<b>EQUIPMENT:</b>	5.15m + 2.10m	<b>SAFETY FACTOR:</b>	67.0%
<b>COMMENT:</b>			

**Komatsu PW160-7**  
**Max Capacity Contours of Radius(m) Plots 2.1m Dipper**  
**Gradient 1 in -25 Height 2m Lift QH**  
**Unlocked Rail Cant 150mm**

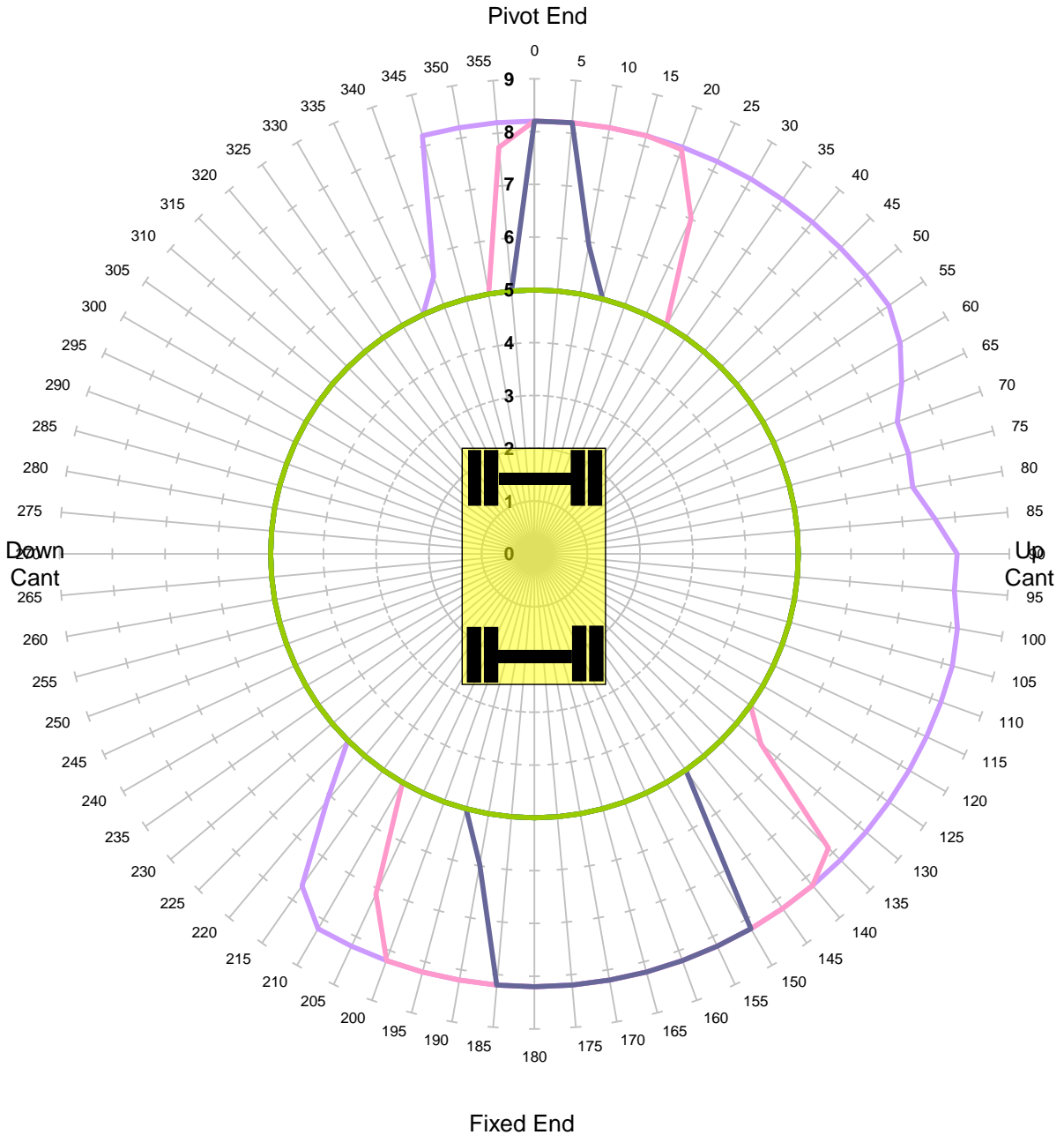

Units in Tonnes

- 1
- 2
- 3
- 4
- 5
- 6
- 7
- 8
- 9
- 10

<b>MACHINE &amp; MODEL:</b>	Komatsu PW160-7	<b>REFERENCE:</b>	
<b>SERIAL No:</b>	H50093	<b>DATE OF CHART:</b>	19-Oct-2021
<b>EQUIPMENT:</b>	5.15m + 2.10m	<b>SAFETY FACTOR:</b>	67.0%
<b>COMMENT:</b>			

**Komatsu PW160-7**  
**Max Capacity Contours of Radius(m) Plots 2.1m Dipper**  
**Gradient 1 in -25 Height 2m Lift QH**  
**Locked Rail Cant -150mm**

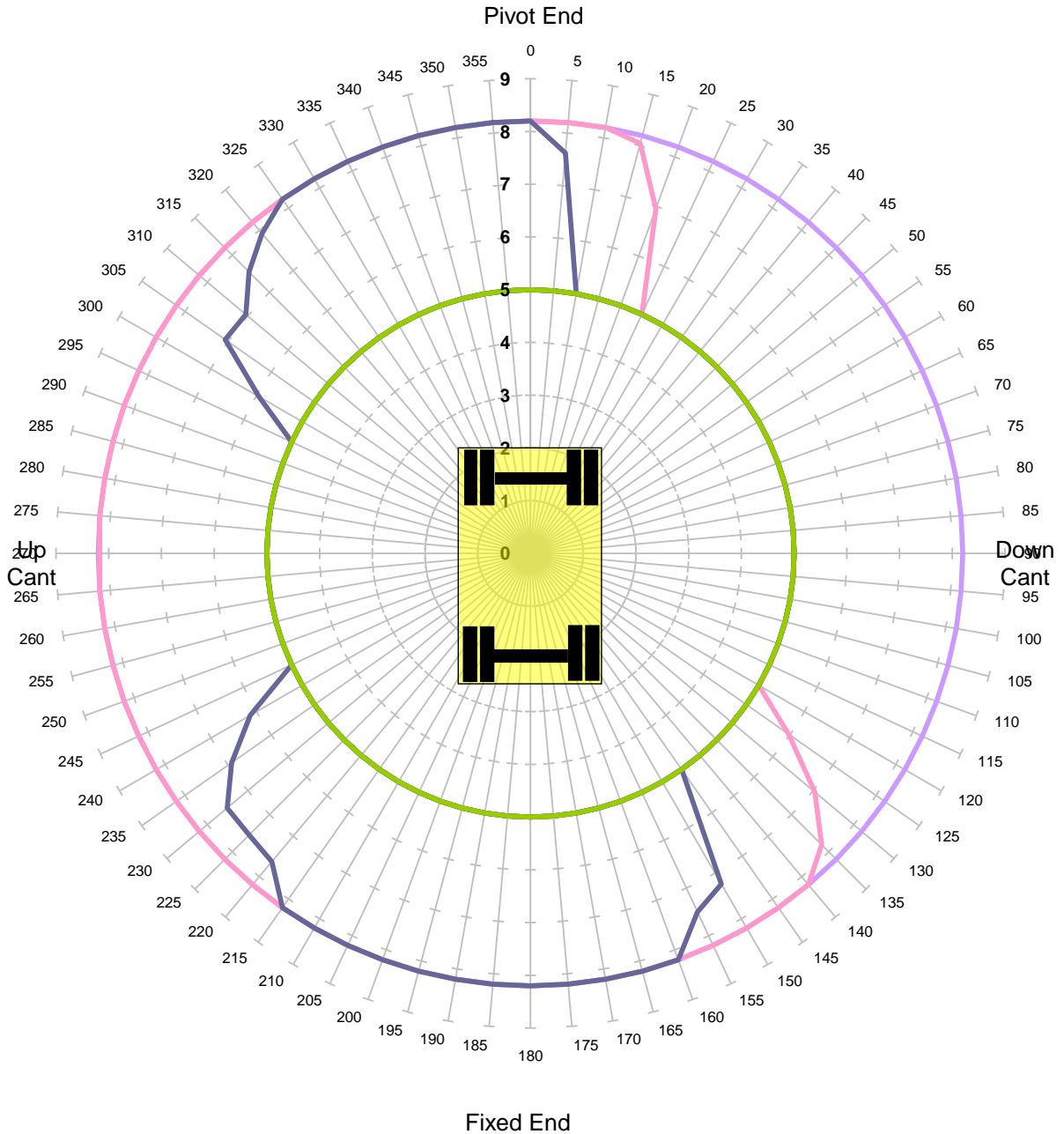

Units in Tonnes

- 1
- 2
- 3
- 4
- 5
- 6
- 7
- 8
- 9
- 10

<b>MACHINE &amp; MODEL:</b>	Komatsu PW160-7	<b>REFERENCE:</b>	
<b>SERIAL No:</b>	H50093	<b>DATE OF CHART:</b>	19-Oct-2021
<b>EQUIPMENT:</b>	5.15m + 2.10m	<b>SAFETY FACTOR:</b>	90.0%
<b>COMMENT:</b>			

**Komatsu PW160-7**  
**Max Capacity Contours of Radius(m) Plots 2.1m Dipper**  
**Gradient 1 in -25 Height 2m Lift QH**  
**Locked Rail Cant -50mm**

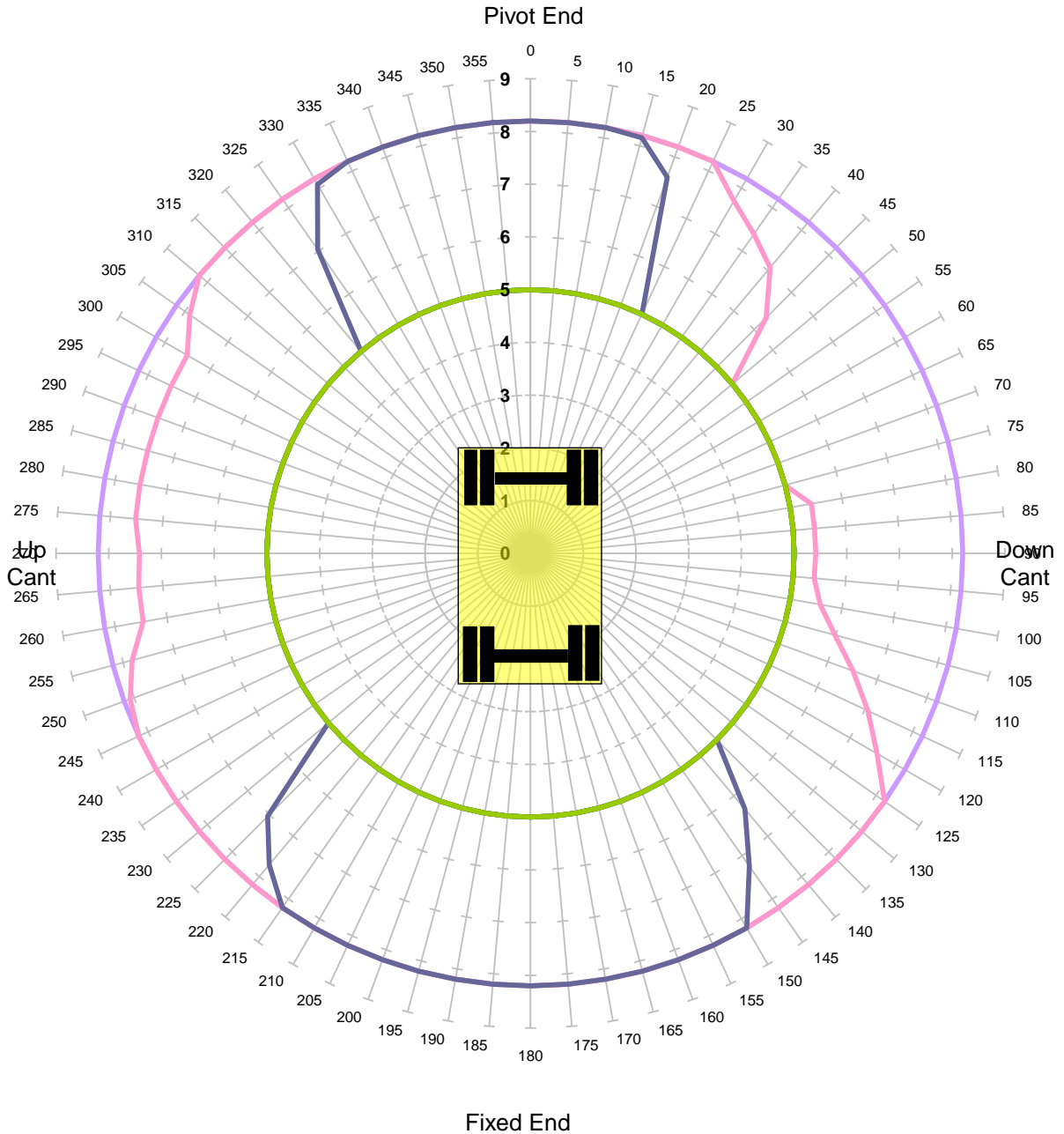

Units in Tonnes

- 1
- 2
- 3
- 4
- 5
- 6
- 7
- 8
- 9
- 10

<b>MACHINE &amp; MODEL:</b>	Komatsu PW160-7	<b>REFERENCE:</b>	
<b>SERIAL No:</b>	H50093	<b>DATE OF CHART:</b>	19-Oct-2021
<b>EQUIPMENT:</b>	5.15m + 2.10m	<b>SAFETY FACTOR:</b>	90.0%
<b>COMMENT:</b>			

**Komatsu PW160-7**  
**Max Capacity Contours of Radius(m) Plots 2.1m Dipper**  
**Gradient 1 in -25 Height 2m Lift QH**  
**Locked Rail Cant 50mm**

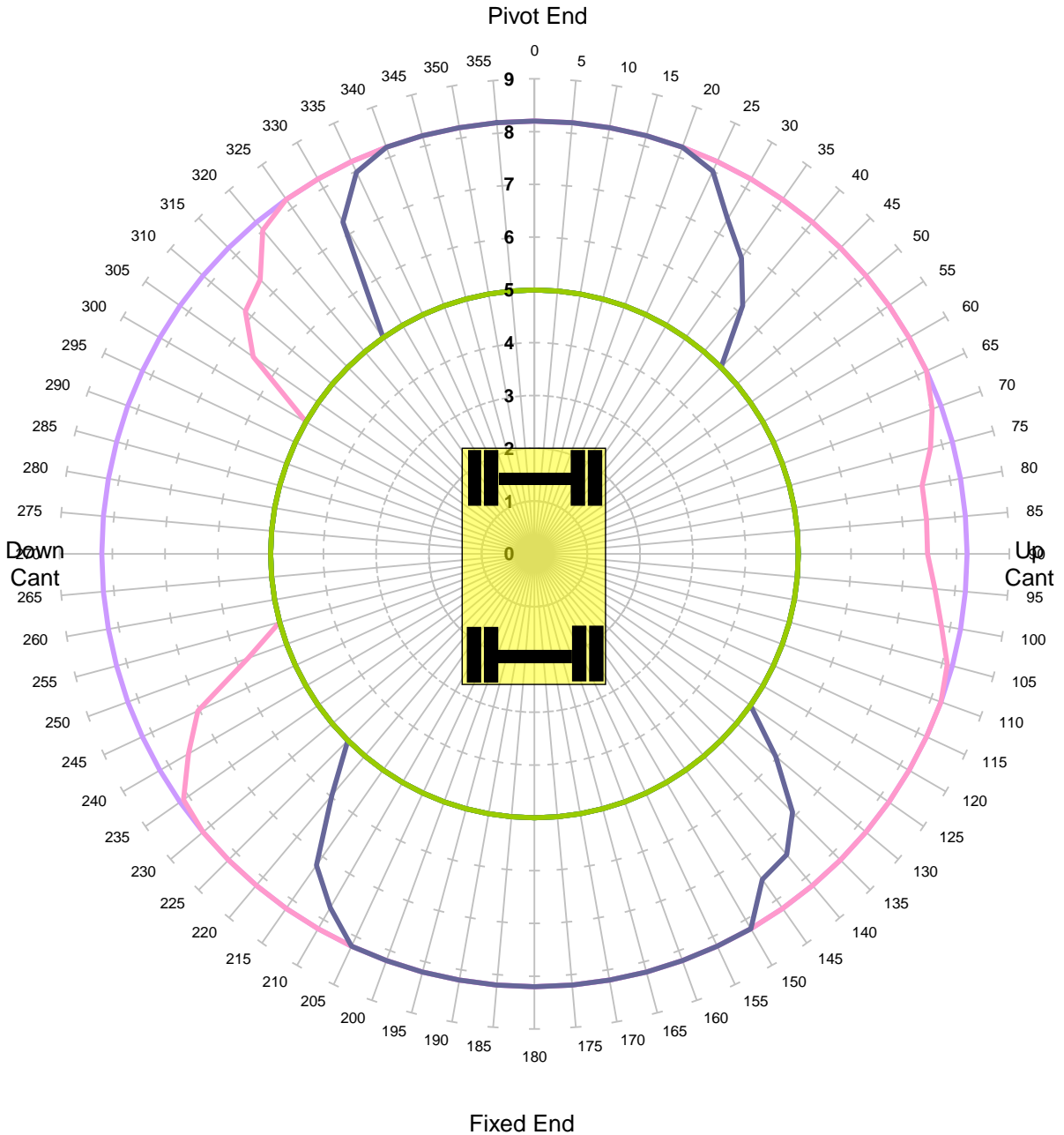

<b>MACHINE &amp; MODEL:</b>	Komatsu PW160-7	<b>REFERENCE:</b>	
<b>SERIAL No:</b>	H50093	<b>DATE OF CHART:</b>	19-Oct-2021
<b>EQUIPMENT:</b>	5.15m + 2.10m	<b>SAFETY FACTOR:</b>	90.0%
<b>COMMENT:</b>			

**Komatsu PW160-7**  
**Max Capacity Contours of Radius(m) Plots 2.1m Dipper**  
**Gradient 1 in -25 Height 2m Lift QH**  
**Locked Rail Cant 150mm**

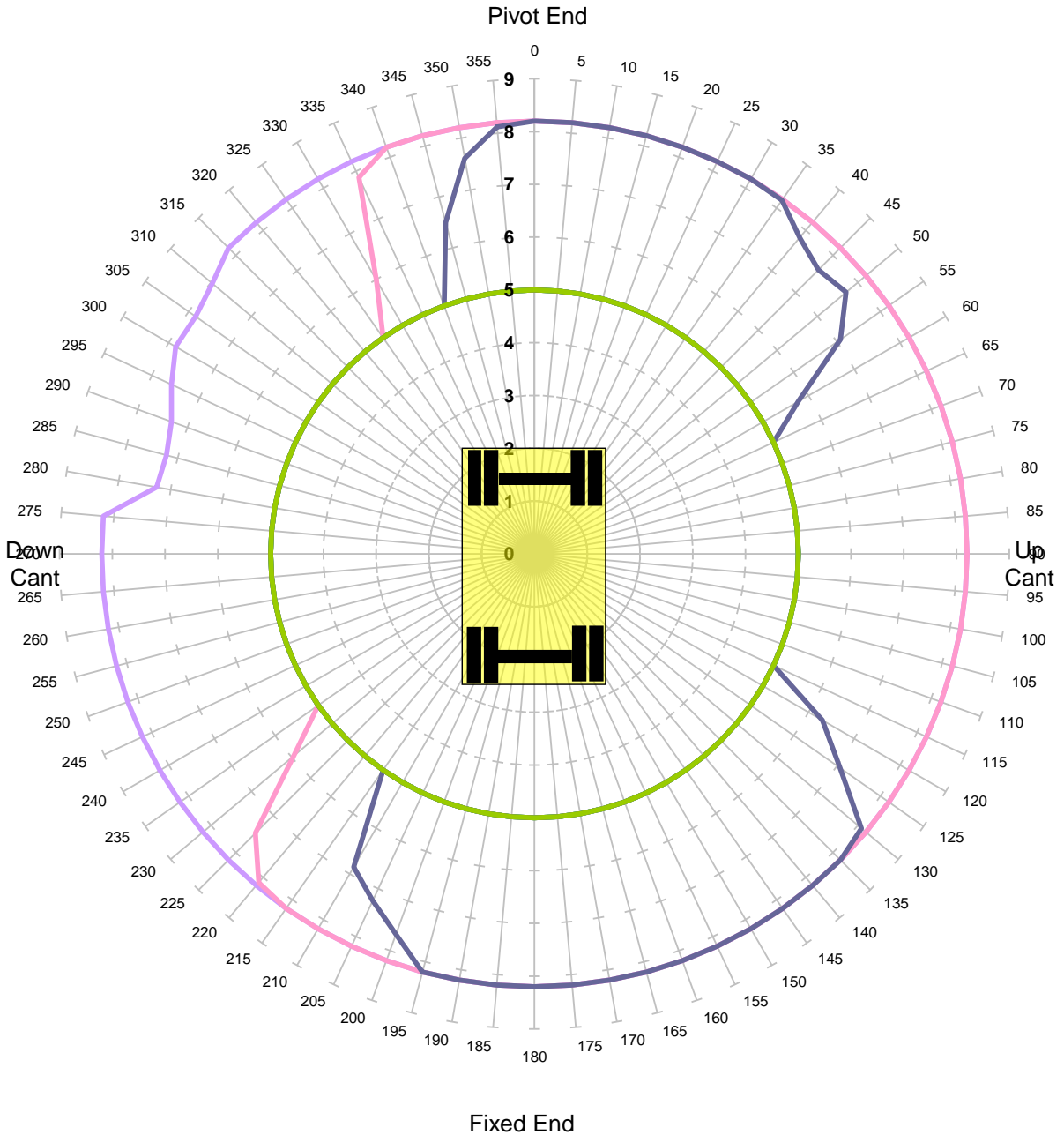

Units in Tonnes

- 1
- 2
- 3
- 4
- 5
- 6
- 7
- 8
- 9
- 10

<b>MACHINE &amp; MODEL:</b>	Komatsu PW160-7	<b>REFERENCE:</b>	
<b>SERIAL No:</b>	H50093	<b>DATE OF CHART:</b>	19-Oct-2021
<b>EQUIPMENT:</b>	5.15m + 2.10m	<b>SAFETY FACTOR:</b>	90.0%
<b>COMMENT:</b>			



**Komatsu PW160-7**  
**Max Capacity Contours of Radius(m) Plots 2.1m Dipper**  
**Level Ground Height 2m Lift QH**  
**Unlocked Road**

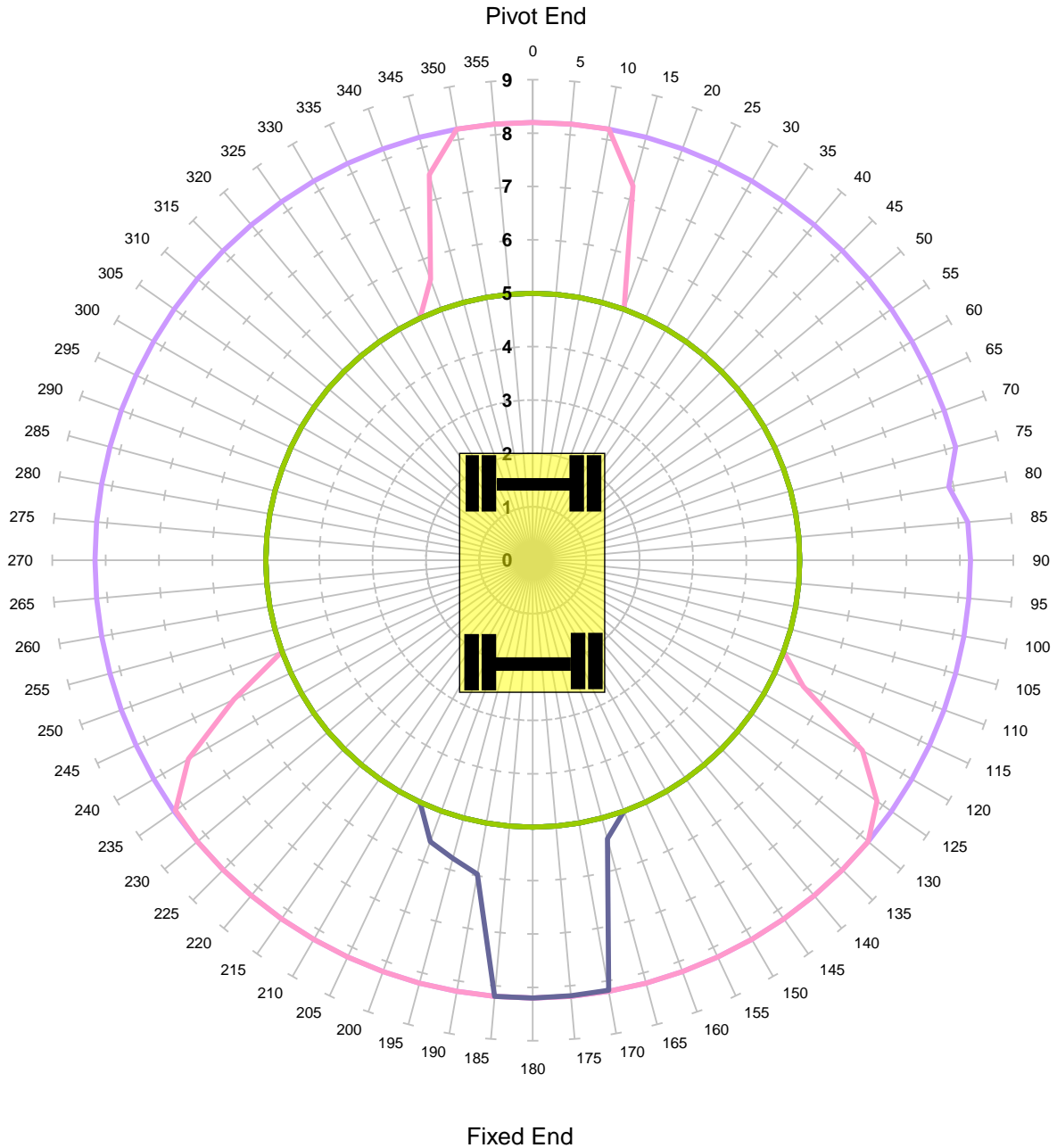

Units in Tonnes

- 1
- 2
- 3
- 4
- 5
- 6
- 7
- 8
- 9
- 10

<b>MACHINE &amp; MODEL:</b>	Komatsu PW160-7	<b>REFERENCE:</b>	
<b>SERIAL No:</b>	H50093	<b>DATE OF CHART:</b>	19-Oct-2021
<b>EQUIPMENT:</b>	5.15m + 2.10m	<b>SAFETY FACTOR:</b>	71.0%
<b>COMMENT:</b>			

**Komatsu PW160-7**  
**Max Capacity Contours of Radius(m) Plots 2.1m Dipper**  
**Level Ground Height 2m Lift QH**  
**Locked Road**

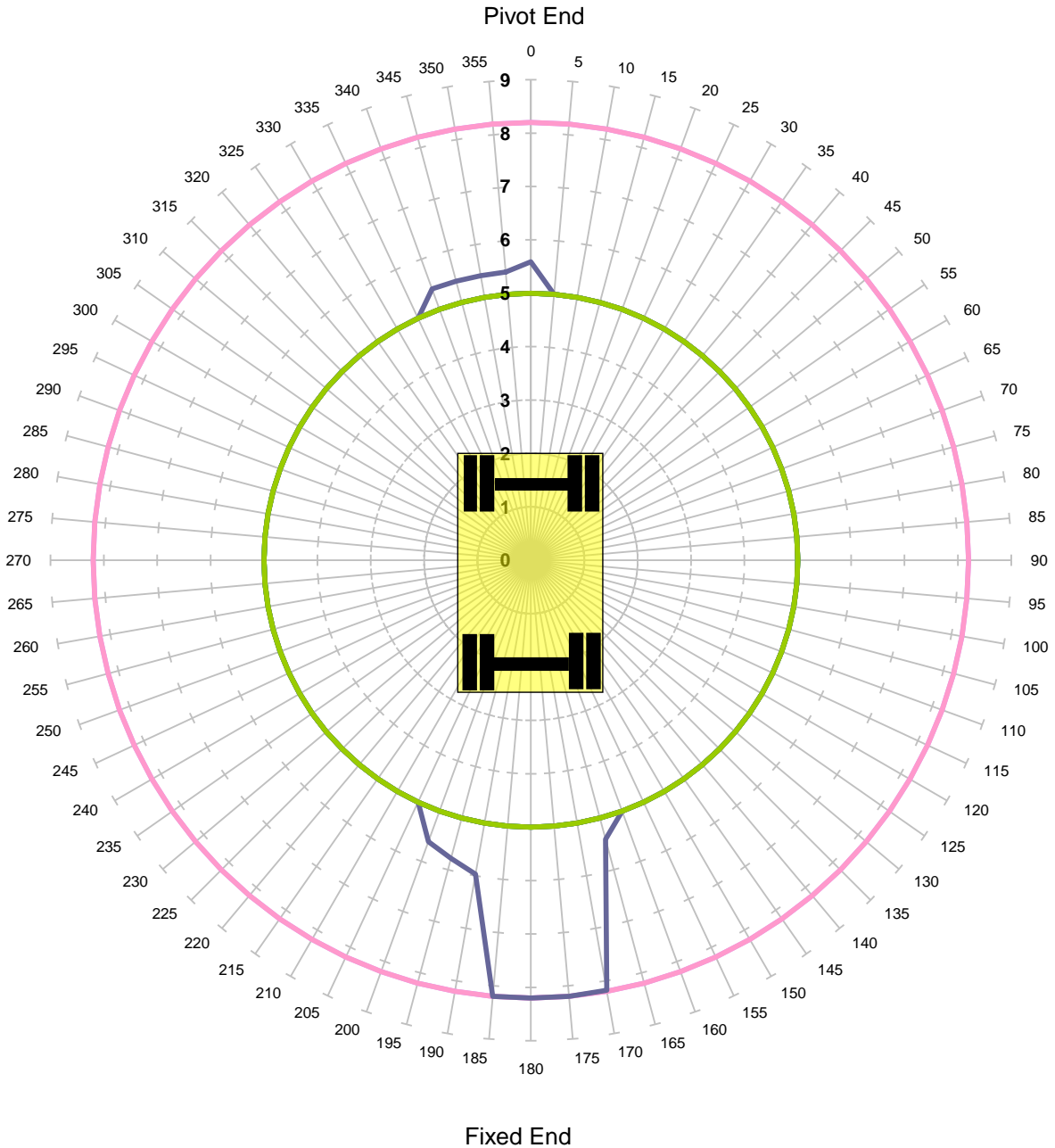

Units in Tonnes

- 1
- 2
- 3
- 4
- 5
- 6
- 7
- 8
- 9
- 10

<b>MACHINE &amp; MODEL:</b>	Komatsu PW160-7	<b>REFERENCE:</b>	
<b>SERIAL No:</b>	H50093	<b>DATE OF CHART:</b>	19-Oct-2021
<b>EQUIPMENT:</b>	5.15m + 2.10m	<b>SAFETY FACTOR:</b>	71.0%
<b>COMMENT:</b>			

**Komatsu PW160-7**  
**Max Capacity Contours of Radius(m) Plots 2.1m Dipper**  
**Gradient 1 in -25 Height 2m Lift QH**  
**Unlocked Rail Cant -150mm - Tandem Lift**

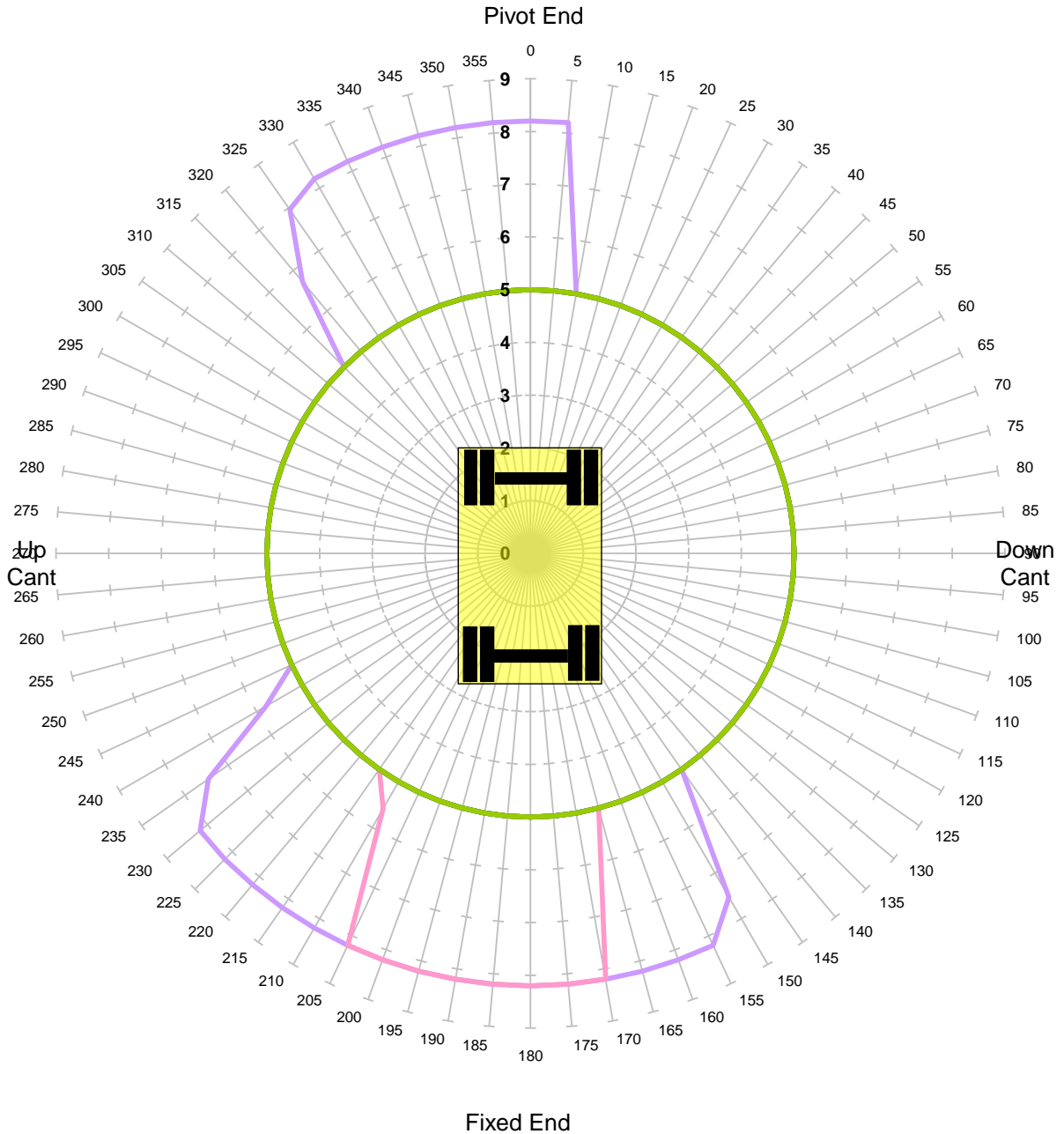

Units in Tonnes

- 1
- 2
- 3
- 4
- 5
- 6
- 7
- 8
- 9
- 10

<b>MACHINE &amp; MODEL:</b>	Komatsu PW160-7	<b>REFERENCE:</b>	
<b>SERIAL No:</b>	H50093	<b>DATE OF CHART:</b>	19-Oct-2021
<b>EQUIPMENT:</b>	5.15m + 2.10m	<b>SAFETY FACTOR:</b>	44.0%
<b>COMMENT:</b>			

**Komatsu PW160-7**  
**Max Capacity Contours of Radius(m) Plots 2.1m Dipper**  
**Gradient 1 in -25 Height 2m Lift QH**  
**Unlocked Rail Cant -50mm - Tandem Lift**

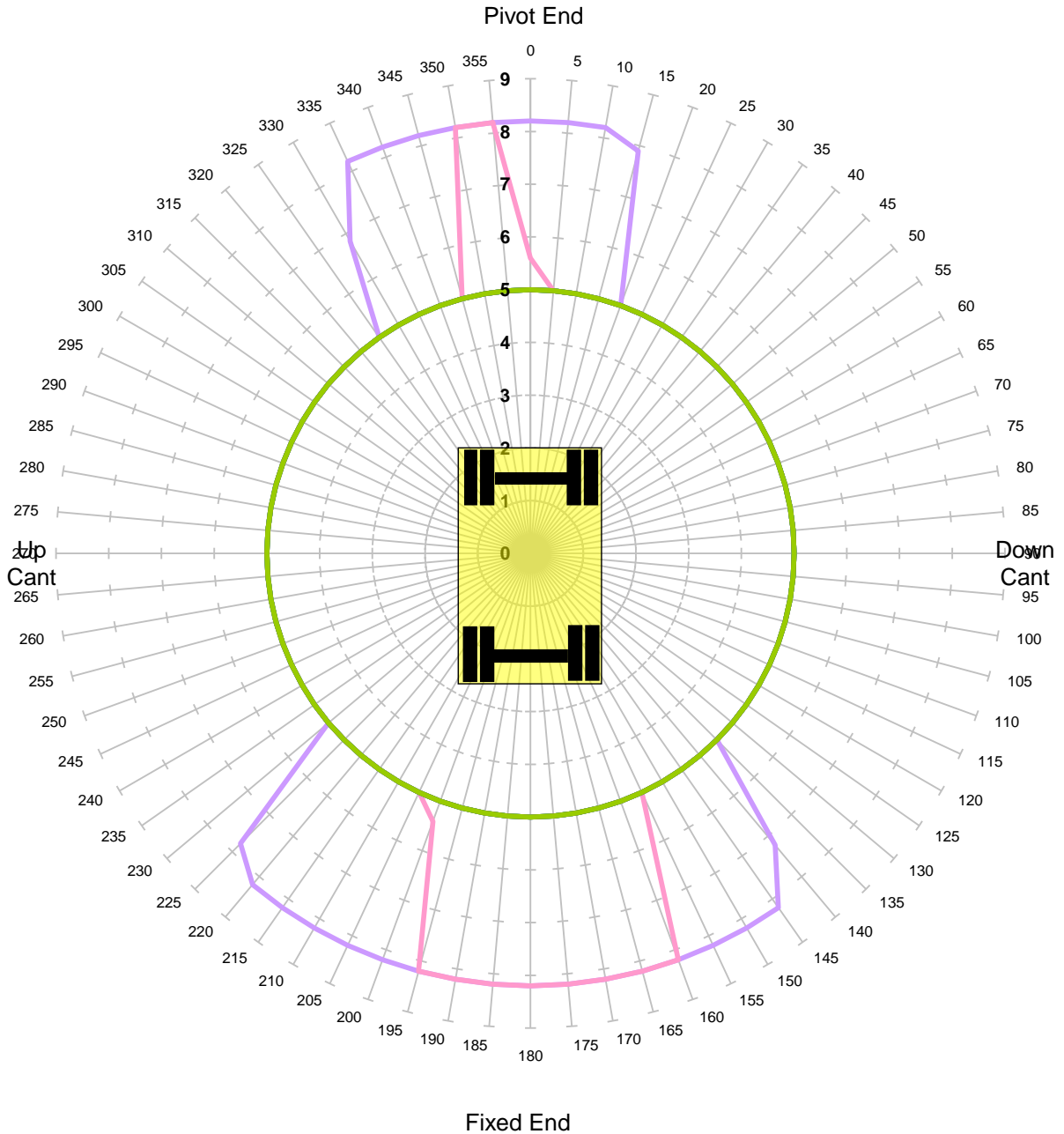

Units in Tonnes

- 1
- 2
- 3
- 4
- 5
- 6
- 7
- 8
- 9
- 10

<b>MACHINE &amp; MODEL:</b>	Komatsu PW160-7	<b>REFERENCE:</b>	
<b>SERIAL No:</b>	H50093	<b>DATE OF CHART:</b>	19-Oct-2021
<b>EQUIPMENT:</b>	5.15m + 2.10m	<b>SAFETY FACTOR:</b>	44.0%
<b>COMMENT:</b>			

**Komatsu PW160-7**  
**Max Capacity Contours of Radius(m) Plots 2.1m Dipper**  
**Gradient 1 in -25 Height 2m Lift QH**  
**Unlocked Rail Cant 50mm - Tandem Lift**

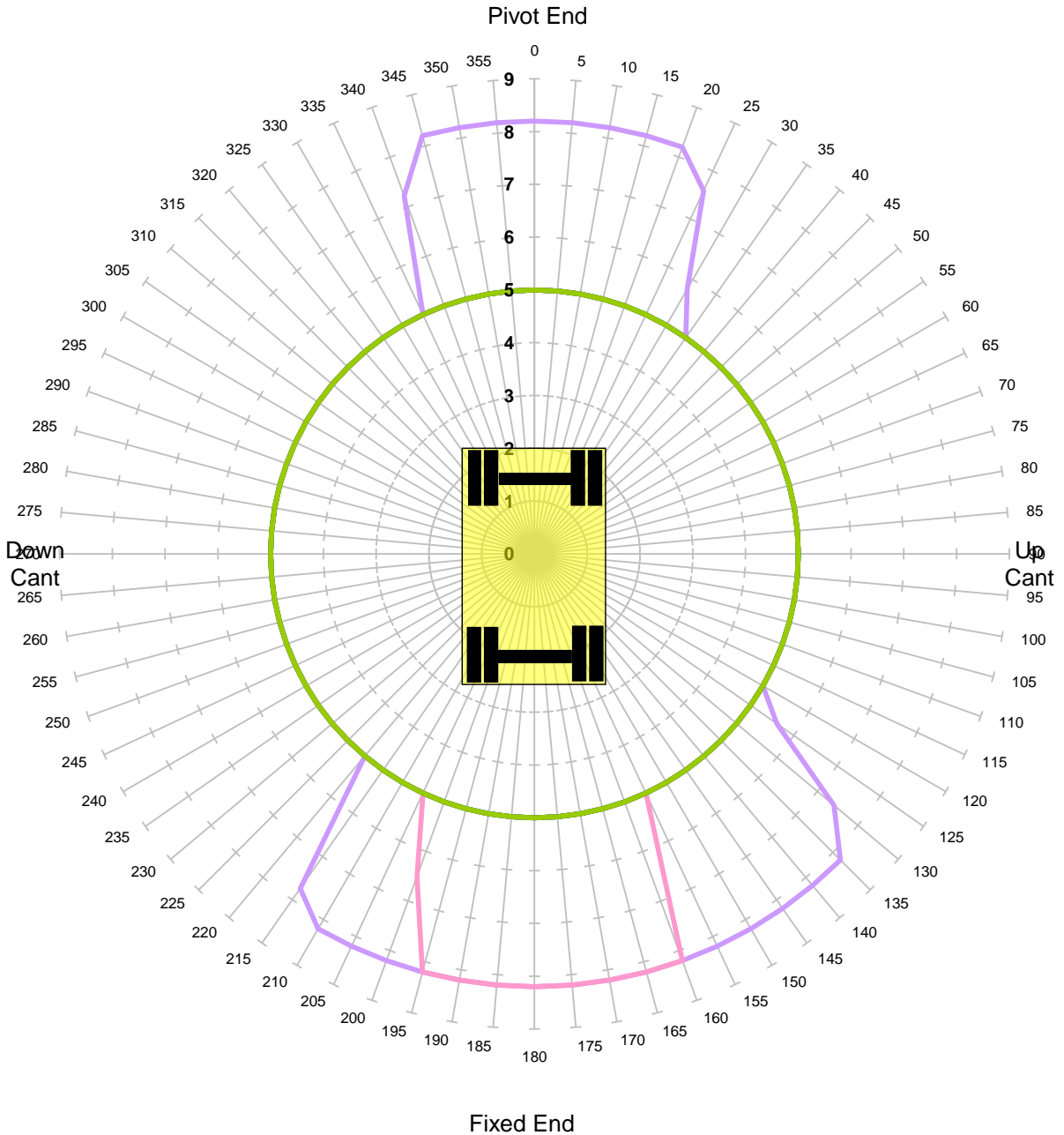

Units in Tonnes



<b>MACHINE &amp; MODEL:</b>	Komatsu PW160-7	<b>REFERENCE:</b>	
<b>SERIAL No:</b>	H50093	<b>DATE OF CHART:</b>	19-Oct-2021
<b>EQUIPMENT:</b>	5.15m + 2.10m	<b>SAFETY FACTOR:</b>	44.0%
<b>COMMENT:</b>			

**Komatsu PW160-7**  
**Max Capacity Contours of Radius(m) Plots 2.1m Dipper**  
**Gradient 1 in -25 Height 2m Lift QH**  
**Unlocked Rail Cant 150mm - Tandem Lift**

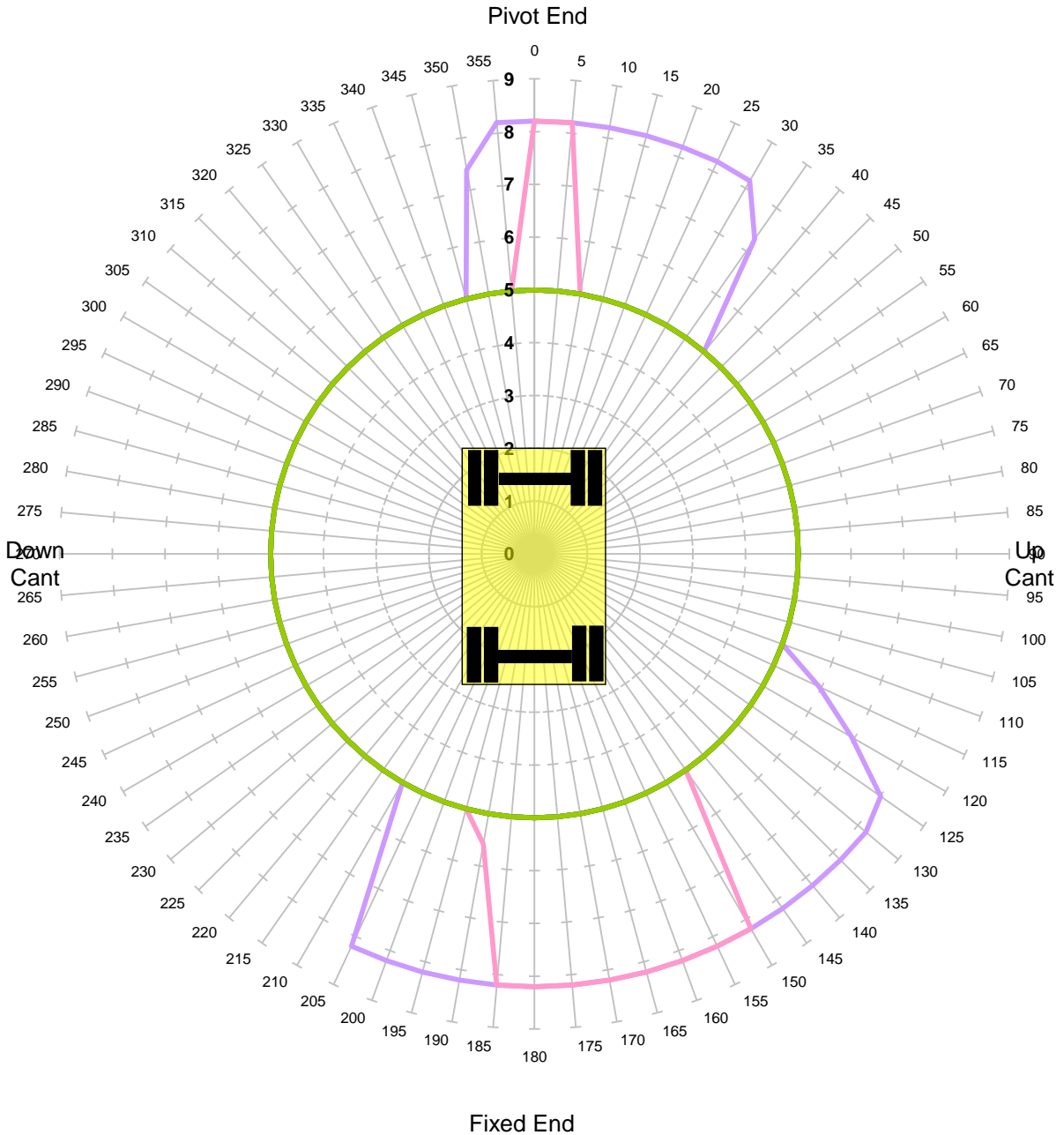

Units in Tonnes

- 1
- 2
- 3
- 4
- 5
- 6
- 7
- 8
- 9
- 10

<b>MACHINE &amp; MODEL:</b>	Komatsu PW160-7	<b>REFERENCE:</b>	
<b>SERIAL No:</b>	H50093	<b>DATE OF CHART:</b>	19-Oct-2021
<b>EQUIPMENT:</b>	5.15m + 2.10m	<b>SAFETY FACTOR:</b>	44.0%
<b>COMMENT:</b>			

**Komatsu PW160-7**  
**Max Capacity Contours of Radius(m) Plots 2.1m Dipper**  
**Gradient 1 in -25 Height 2m Lift QH**  
**Locked Rail Cant -150mm - Tandem Lift**

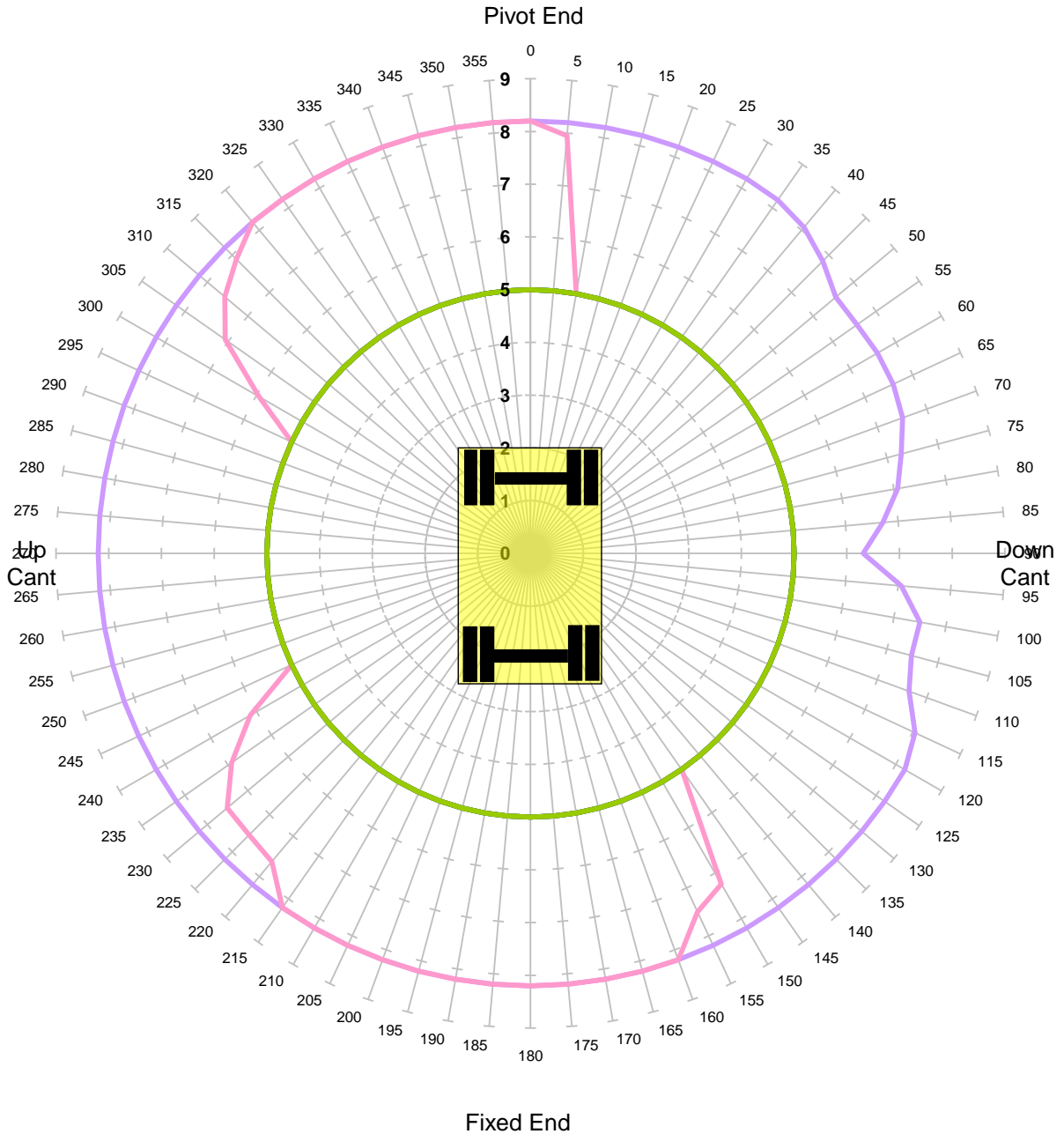

Units in Tonnes

- 1
- 2
- 3
- 4
- 5
- 6
- 7
- 8
- 9
- 10

<b>MACHINE &amp; MODEL:</b>	Komatsu PW160-7	<b>REFERENCE:</b>	
<b>SERIAL No:</b>	H50093	<b>DATE OF CHART:</b>	19-Oct-2021
<b>EQUIPMENT:</b>	5.15m + 2.10m	<b>SAFETY FACTOR:</b>	59.0%
<b>COMMENT:</b>			

**Komatsu PW160-7**  
**Max Capacity Contours of Radius(m) Plots 2.1m Dipper**  
**Gradient 1 in -25 Height 2m Lift QH**  
**Locked Rail Cant -50mm - Tandem Lift**

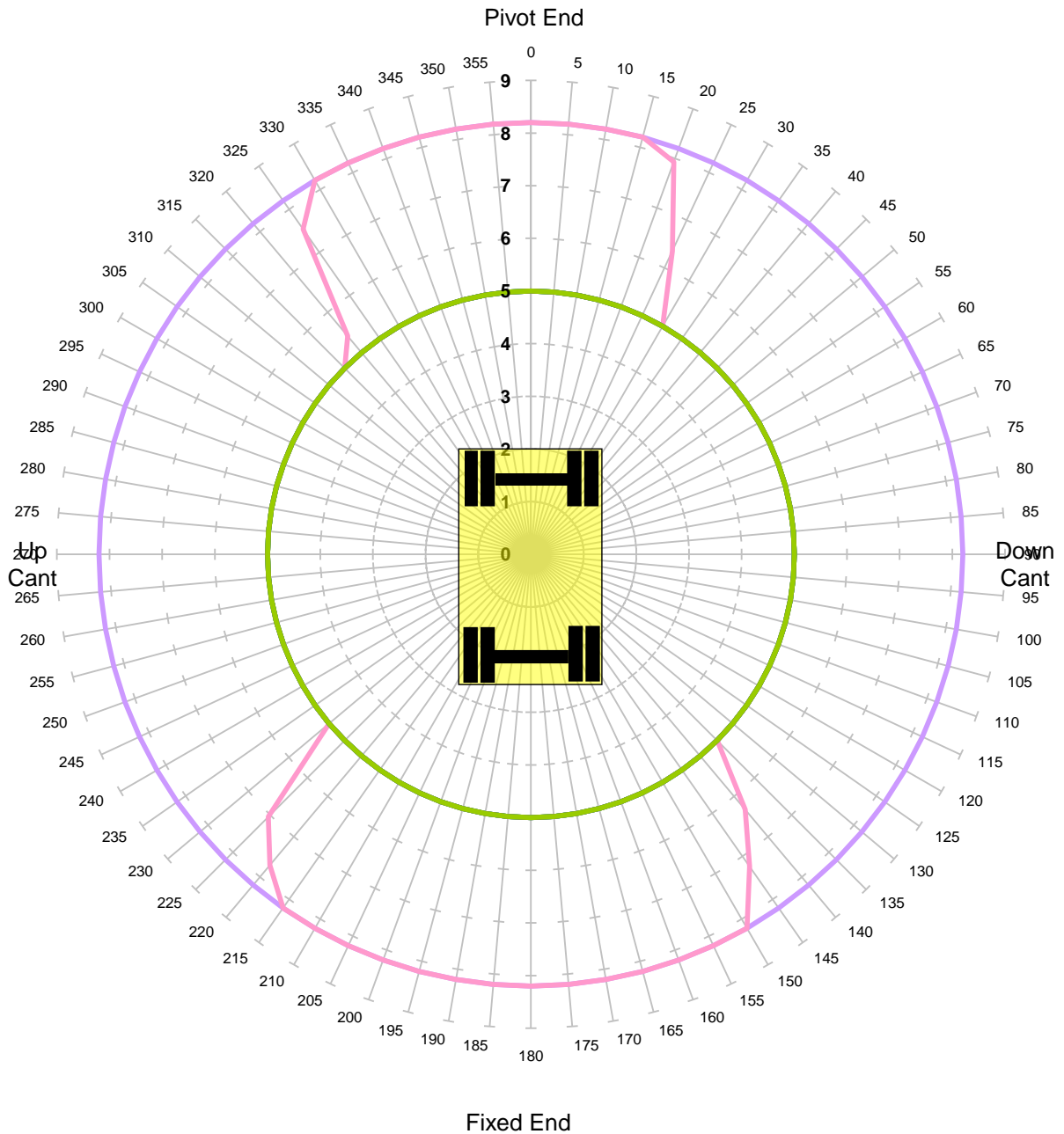

Units in Tonnes

- 1
- 2
- 3
- 4
- 5
- 6
- 7
- 8
- 9
- 10

<b>MACHINE &amp; MODEL:</b>	Komatsu PW160-7	<b>REFERENCE:</b>	
<b>SERIAL No:</b>	H50093	<b>DATE OF CHART:</b>	19-Oct-2021
<b>EQUIPMENT:</b>	5.15m + 2.10m	<b>SAFETY FACTOR:</b>	59.0%
<b>COMMENT:</b>			



**Komatsu PW160-7**  
**Max Capacity Contours of Radius(m) Plots 2.1m Dipper**  
**Gradient 1 in -25 Height 2m Lift QH**  
**Locked Rail Cant 50mm - Tandem Lift**

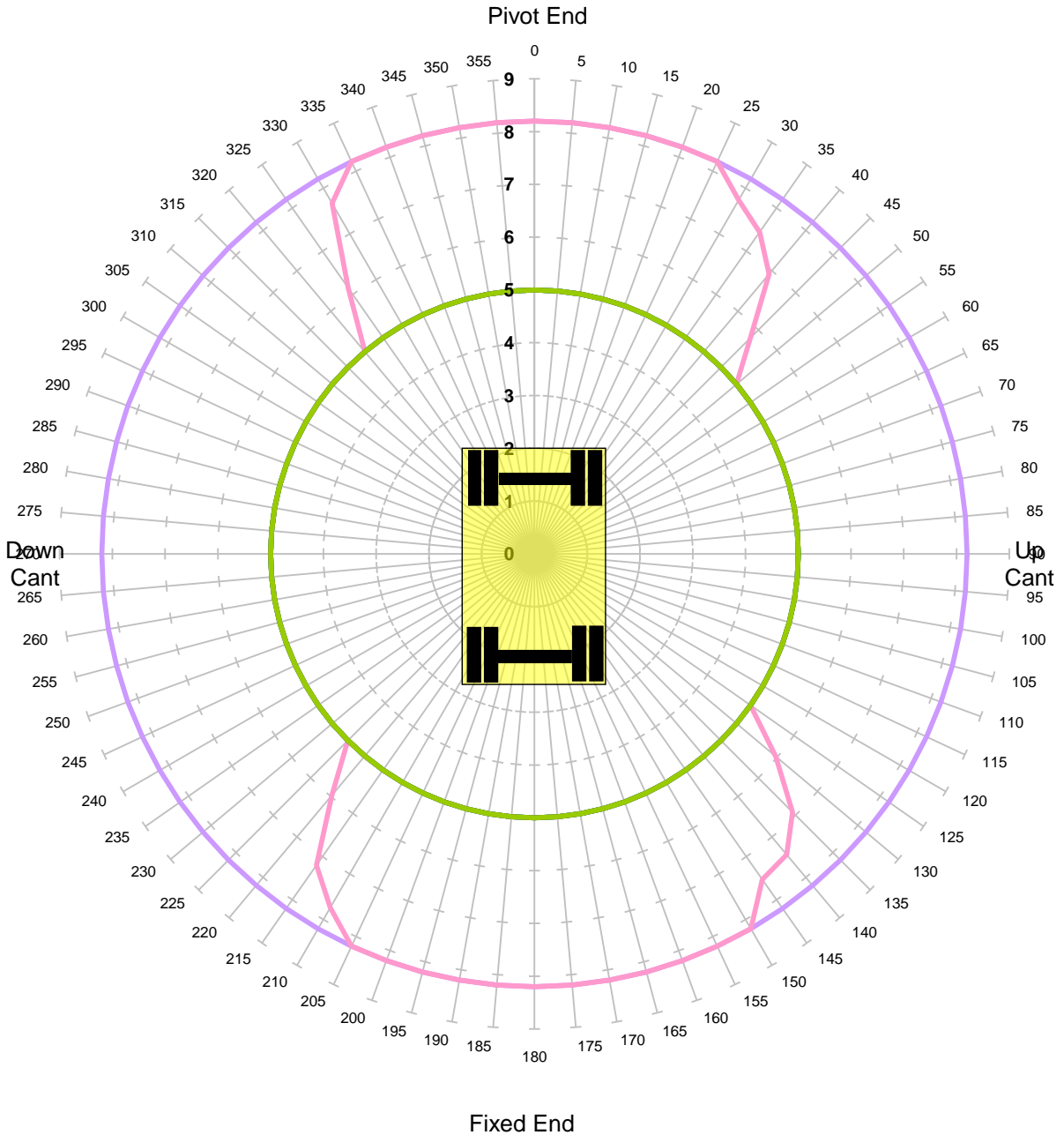

Units in Tonnes

- 1
- 2
- 3
- 4
- 5
- 6
- 7
- 8
- 9
- 10

<b>MACHINE &amp; MODEL:</b>	Komatsu PW160-7	<b>REFERENCE:</b>	
<b>SERIAL No:</b>	H50093	<b>DATE OF CHART:</b>	19-Oct-2021
<b>EQUIPMENT:</b>	5.15m + 2.10m	<b>SAFETY FACTOR:</b>	59.0%
<b>COMMENT:</b>			

**Komatsu PW160-7**  
**Max Capacity Contours of Radius(m) Plots 2.1m Dipper**  
**Gradient 1 in -25 Height 2m Lift QH**  
**Locked Rail Cant 150mm - Tandem Lift**

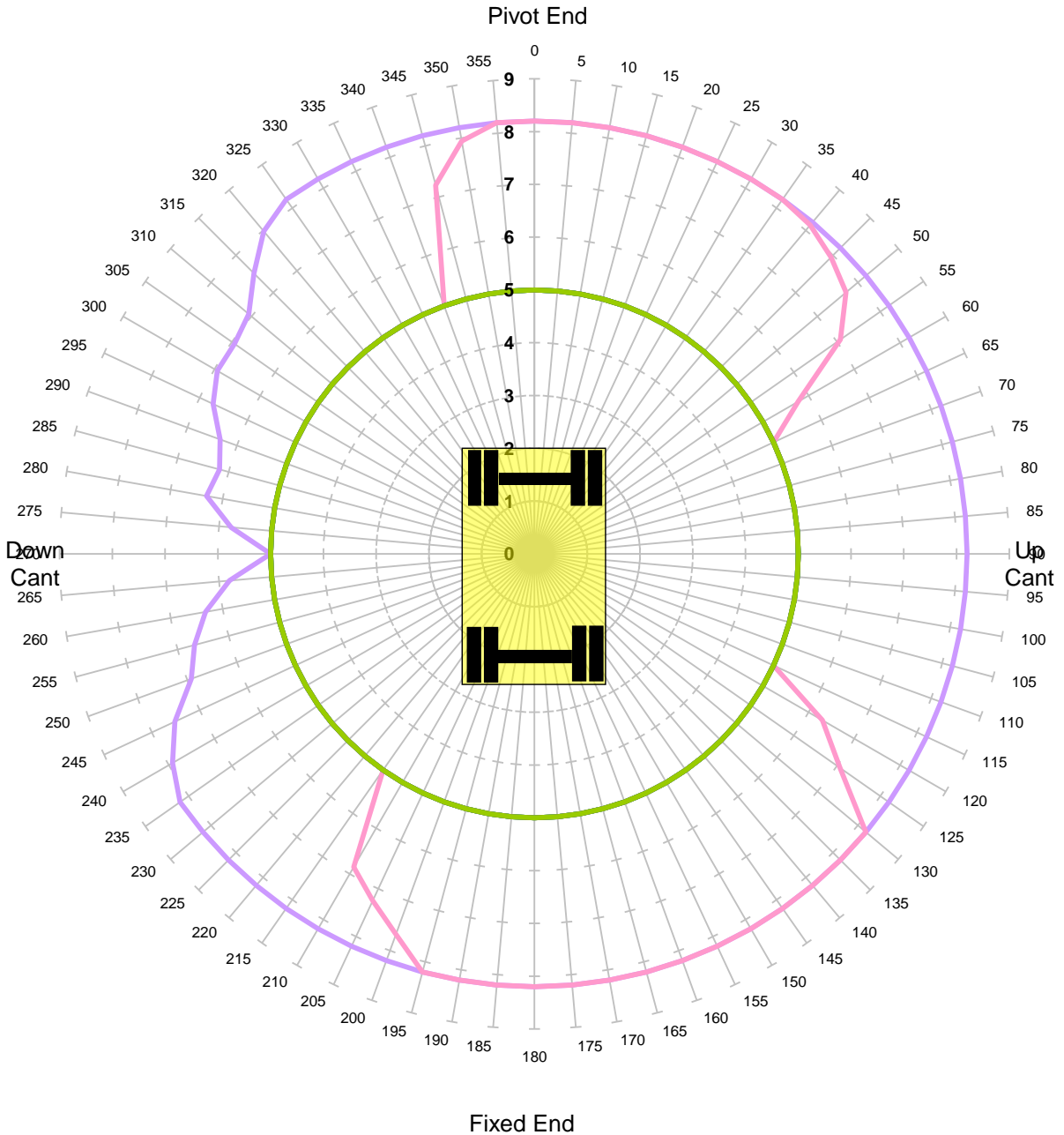

Units in Tonnes

- 1
- 2
- 3
- 4
- 5
- 6
- 7
- 8
- 9
- 10

<b>MACHINE &amp; MODEL:</b>	Komatsu PW160-7	<b>REFERENCE:</b>	
<b>SERIAL No:</b>	H50093	<b>DATE OF CHART:</b>	19-Oct-2021
<b>EQUIPMENT:</b>	5.15m + 2.10m	<b>SAFETY FACTOR:</b>	59.0%
<b>COMMENT:</b>			

**Komatsu PW160-7**  
**Max Capacity Contours of Radius(m) Plots 2.1m Dipper**  
**Level Ground Height 2m Lift QH**  
**Unlocked Road - Tandem Lift**

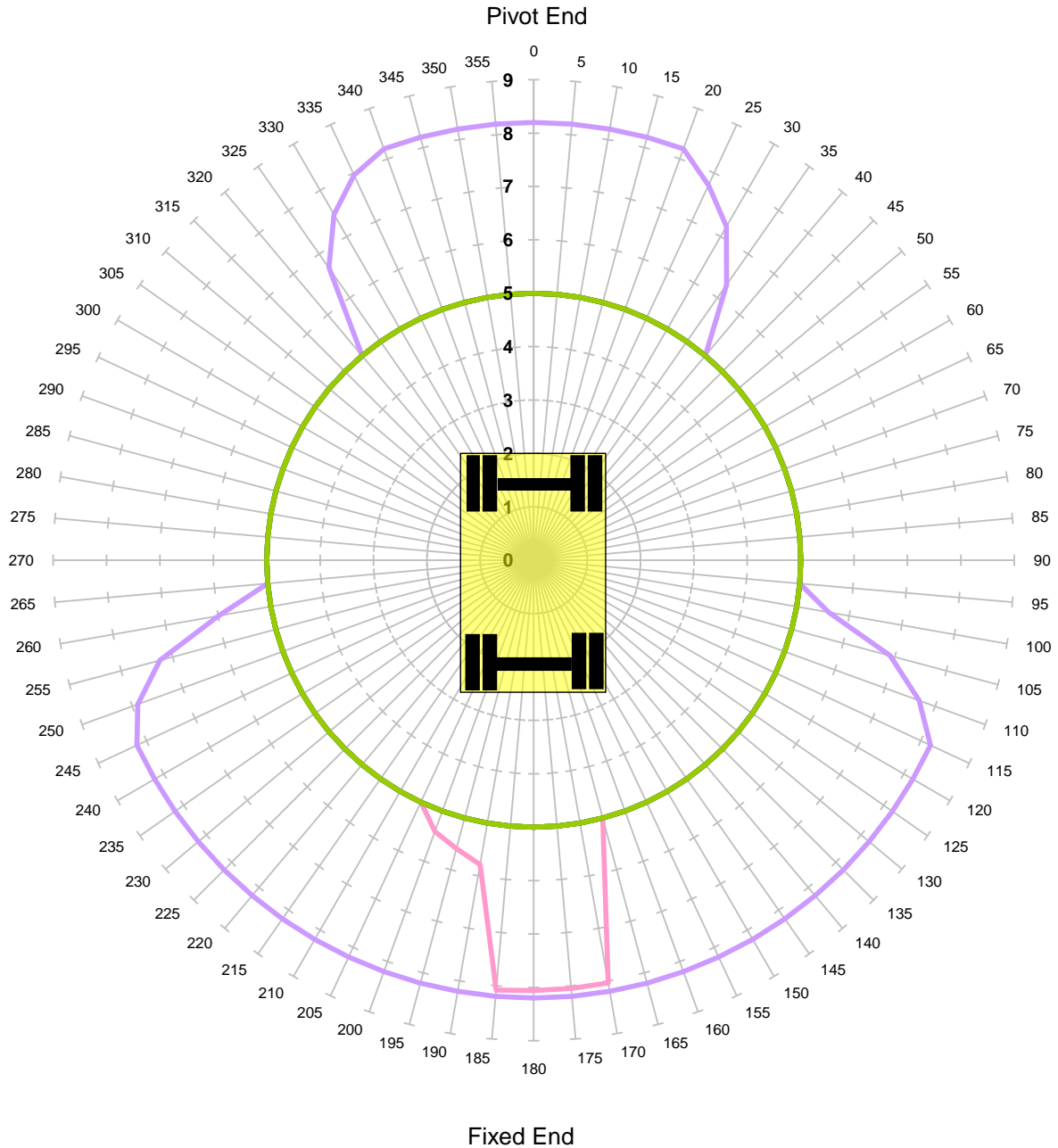

Units in Tonnes

- 1
- 2
- 3
- 4
- 5
- 6
- 7
- 8
- 9
- 10

<b>MACHINE &amp; MODEL:</b>	Komatsu PW160-7	<b>REFERENCE:</b>	
<b>SERIAL No:</b>	H50093	<b>DATE OF CHART:</b>	19-Oct-2021
<b>EQUIPMENT:</b>	5.15m + 2.10m	<b>SAFETY FACTOR:</b>	47.0%
<b>COMMENT:</b>			

**Komatsu PW160-7**  
**Max Capacity Contours of Radius(m) Plots 2.1m Dipper**  
**Level Ground Height 2m Lift QH**  
**Locked Road - Tandem Lift**

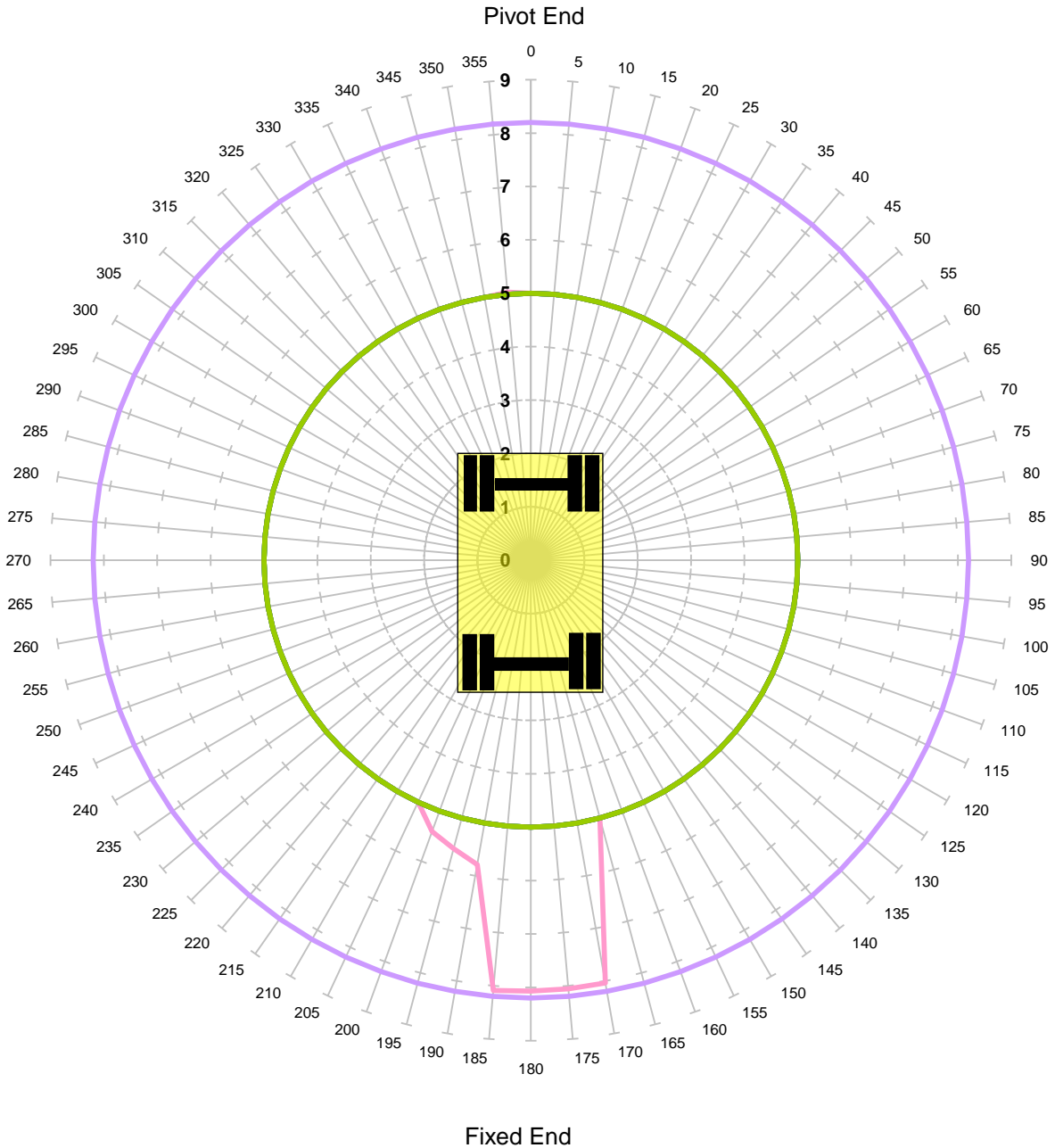

Units in Tonnes

- 1
- 2
- 3
- 4
- 5
- 6
- 7
- 8
- 9
- 10

<b>MACHINE &amp; MODEL:</b>	Komatsu PW160-7	<b>REFERENCE:</b>	
<b>SERIAL No:</b>	H50093	<b>DATE OF CHART:</b>	19-Oct-2021
<b>EQUIPMENT:</b>	5.15m + 2.10m	<b>SAFETY FACTOR:</b>	47.0%
<b>COMMENT:</b>			