

Komatsu PW160-11
Max Capacity Contours of Radius(m) Plots 2.5m Dipper
Gradient 1 in -25 Height 2m Lift BP
Unlocked Rail Cant -150mm

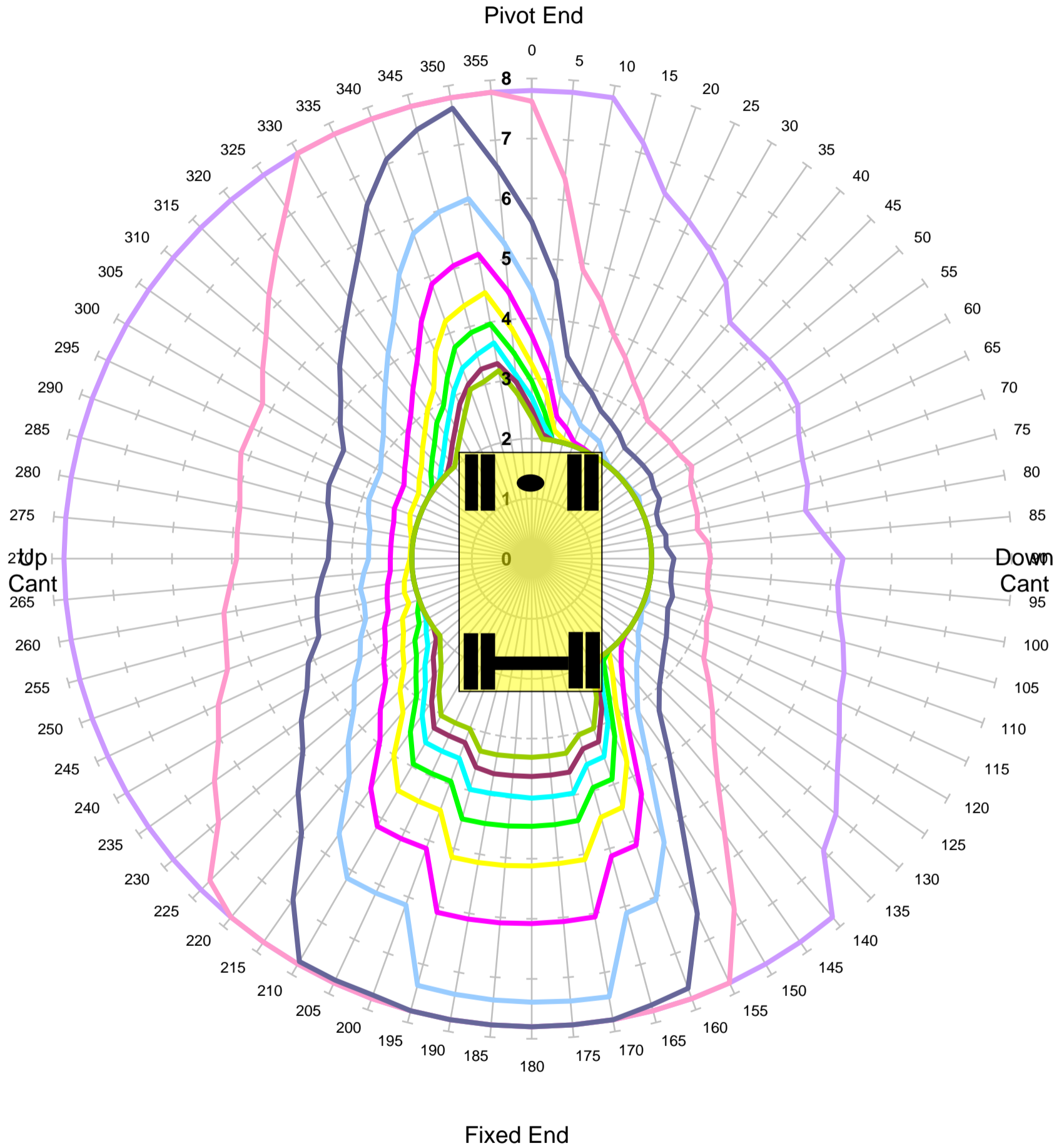

Units in Tonnes

- 1
- 2
- 3
- 4
- 5
- 6
- 7
- 8
- 9
- 10

MACHINE & MODEL:	Komatsu PW160-11	REFERENCE:	3.00m Jib
SERIAL No:	H65493	DATE OF CHART:	12-Sep-2022
EQUIPMENT:	2.00m + 3.47m + 2.50m	SAFETY FACTOR:	67.0%
COMMENT:			

Komatsu PW160-11
Max Capacity Contours of Radius(m) Plots 2.5m Dipper
Gradient 1 in -25 Height 2m Lift BP
Unlocked Rail Cant -50mm

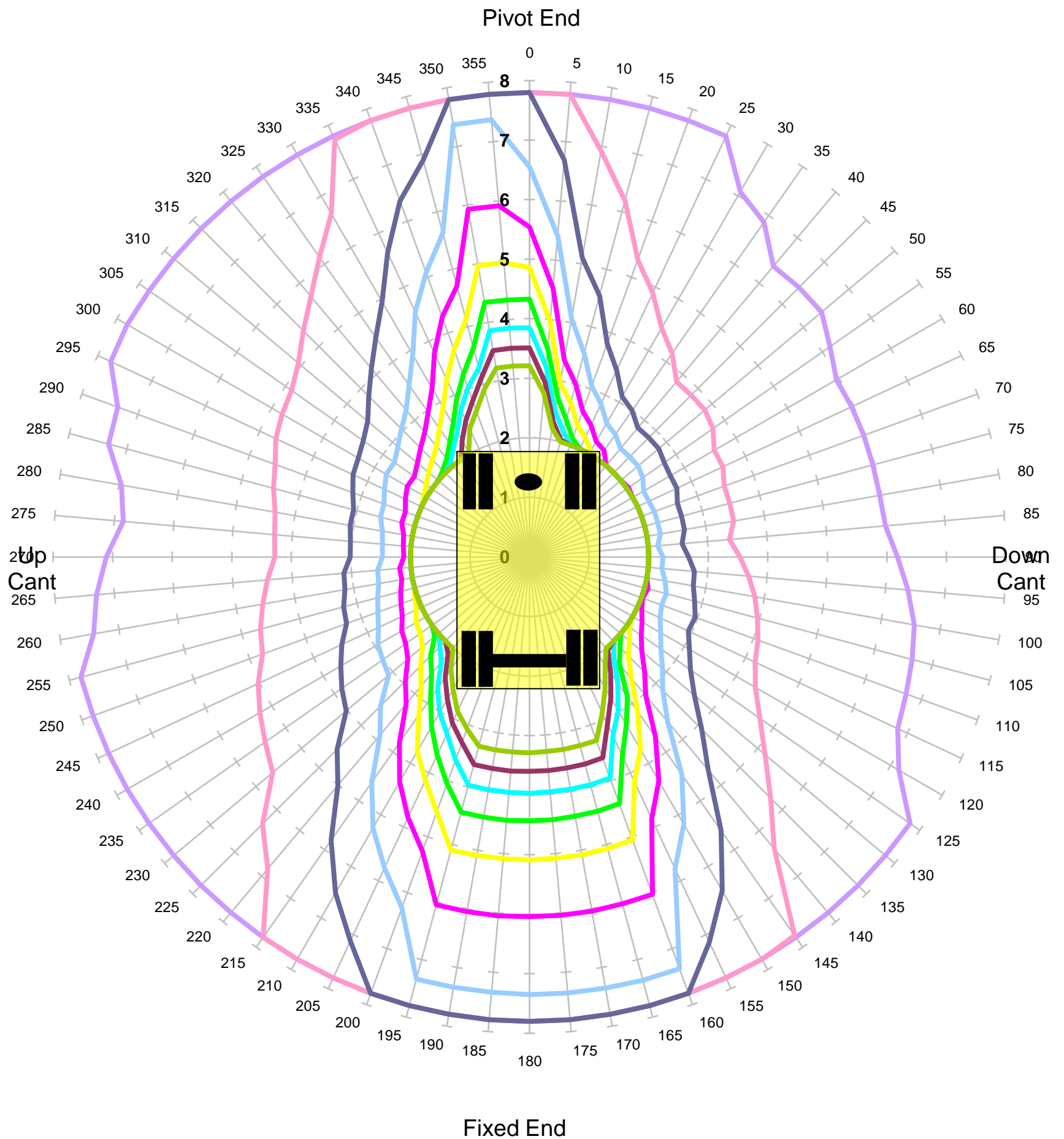

Units in Tonnes

- 1
 — 2
 — 3
 — 4
 — 5
 — 6
 — 7
 — 8
 — 9
 — 10

MACHINE & MODEL:	Komatsu PW160-11	REFERENCE:	3.00m Jib
SERIAL No:	H65493	DATE OF CHART:	12-Sep-2022
EQUIPMENT:	2.00m + 3.47m + 2.50m	SAFETY FACTOR:	67.0%
COMMENT:			

Komatsu PW160-11

**Max Capacity Contours of Radius(m) Plots 2.5m Dipper
Gradient 1 in -25 Height 2m Lift BP
Unlocked Rail Cant 50mm**

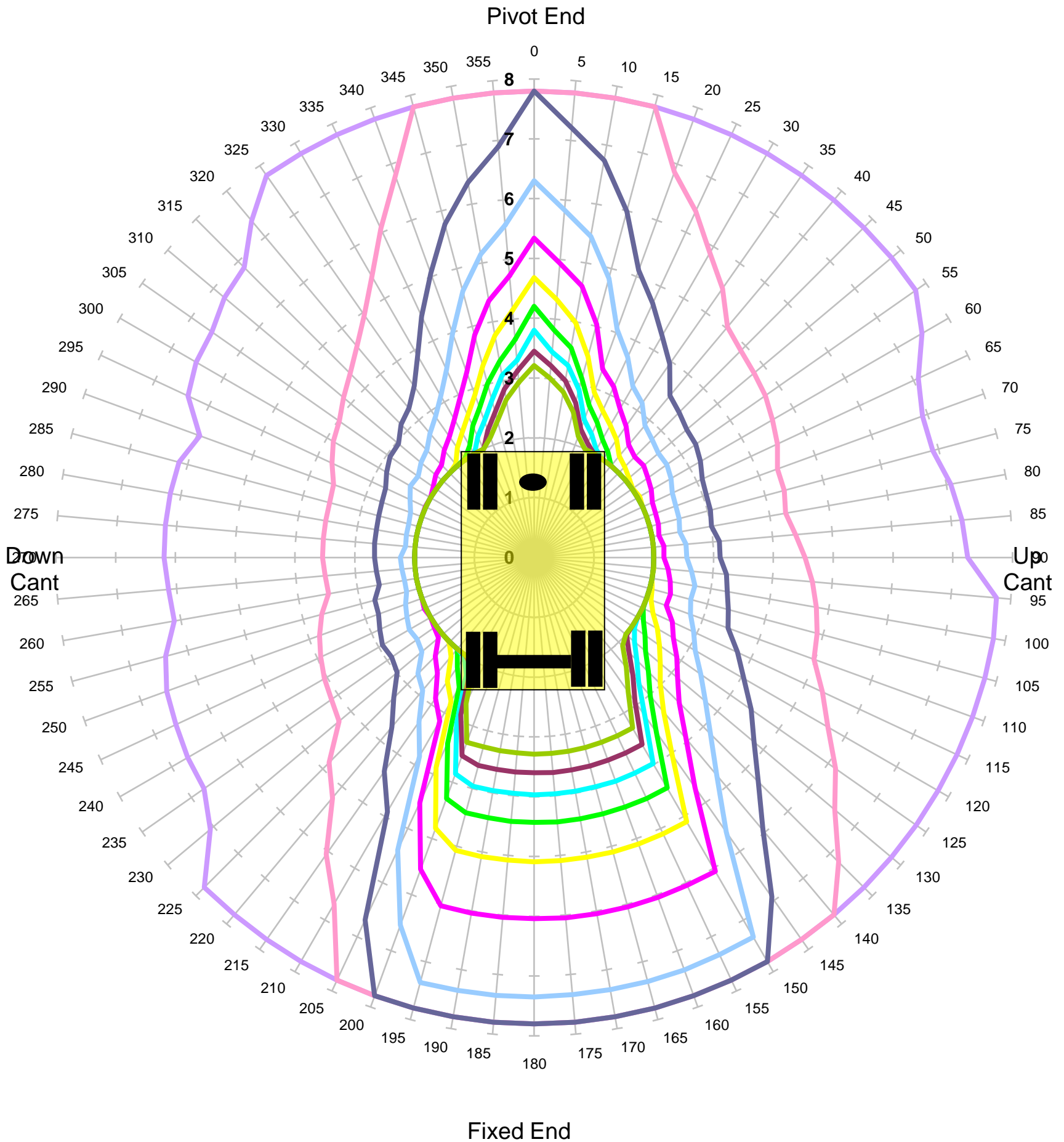

MACHINE & MODEL:	Komatsu PW160-11	REFERENCE:	3.00m Jib
SERIAL No:	H65493	DATE OF CHART:	12-Sep-2022
EQUIPMENT:	2.00m + 3.47m + 2.50m	SAFETY FACTOR:	67.0%
COMMENT:			

Komatsu PW160-11
Max Capacity Contours of Radius(m) Plots 2.5m Dipper
Gradient 1 in -25 Height 2m Lift BP
Unlocked Rail Cant 150mm

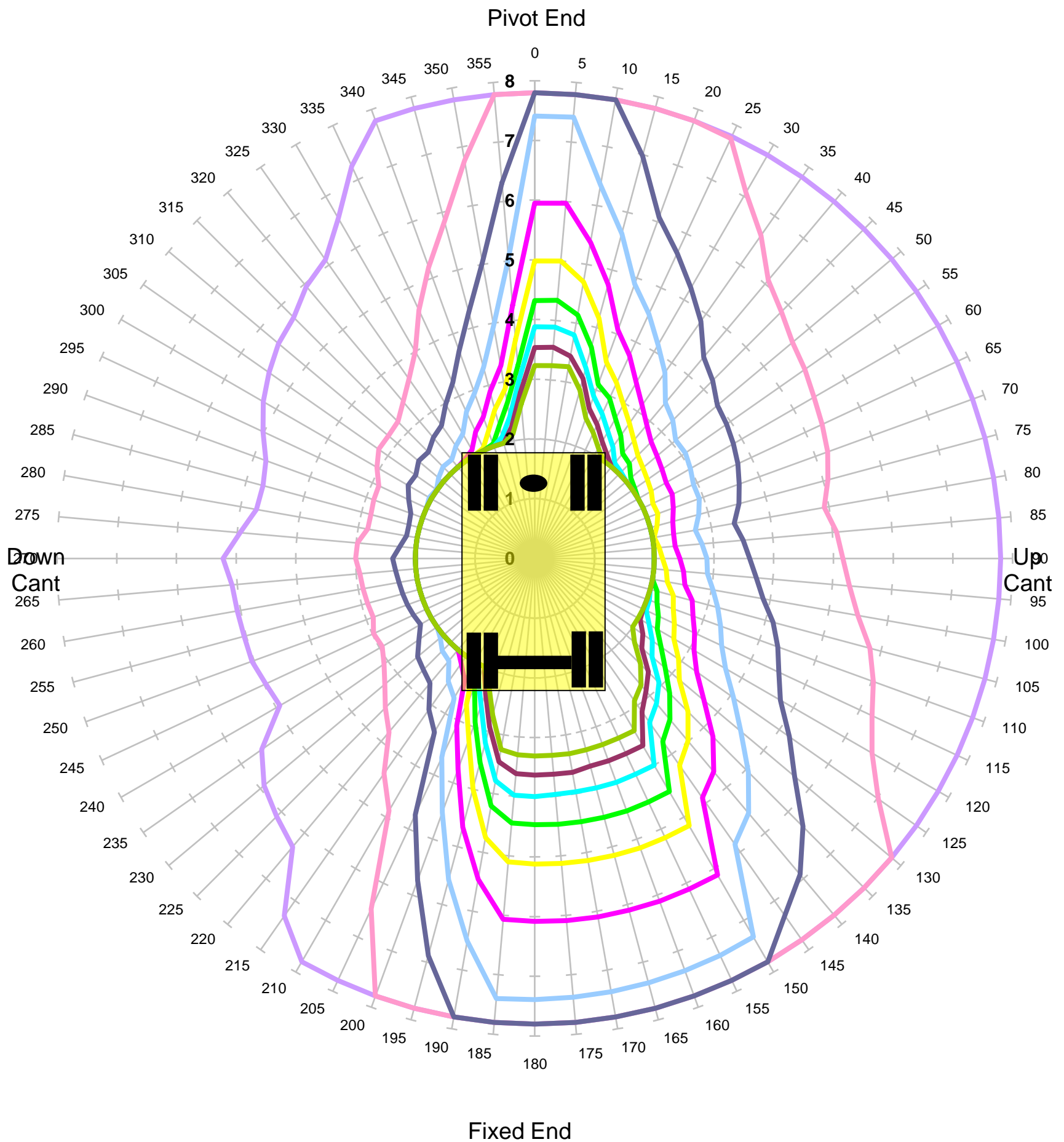

Units in Tonnes

- 1
- 2
- 3
- 4
- 5
- 6
- 7
- 8
- 9
- 10

MACHINE & MODEL:	Komatsu PW160-11	REFERENCE:	3.00m Jib
SERIAL No:	H65493	DATE OF CHART:	12-Sep-2022
EQUIPMENT:	2.00m + 3.47m + 2.50m	SAFETY FACTOR:	67.0%
COMMENT:			

Komatsu PW160-11
Max Capacity Contours of Radius(m) Plots 2.5m Dipper
Gradient 1 in -25 Height 2m Lift BP
Locked Rail Cant -150mm

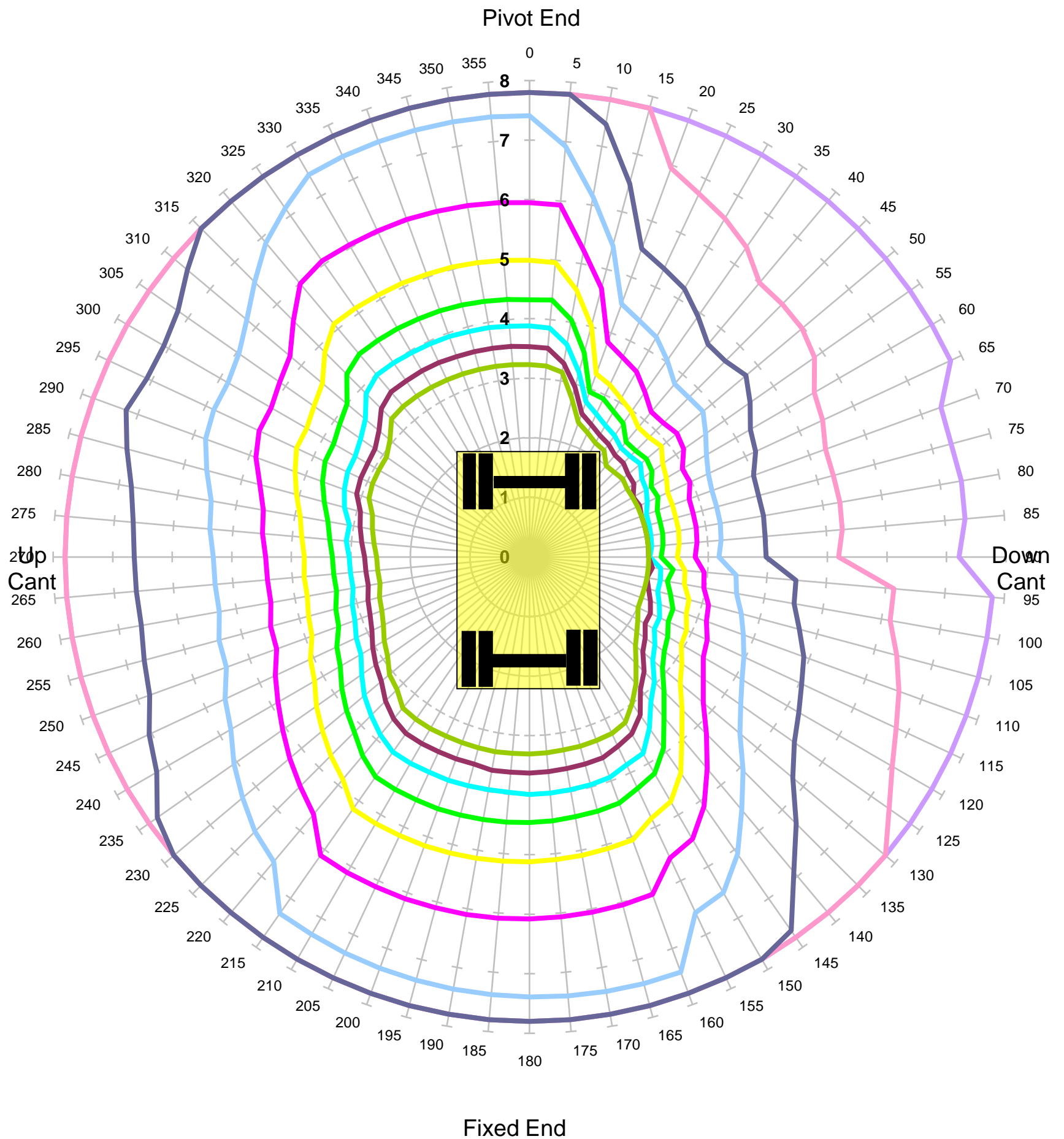

Units in Tonnes

- 1
- 2
- 3
- 4
- 5
- 6
- 7
- 8
- 9
- 10

MACHINE & MODEL:	Komatsu PW160-11	REFERENCE:	3.00m Jib
SERIAL No:	H65493	DATE OF CHART:	12-Sep-2022
EQUIPMENT:	2.00m + 3.47m + 2.50m	SAFETY FACTOR:	90.0%
COMMENT:			

Komatsu PW160-11
Max Capacity Contours of Radius(m) Plots 2.5m Dipper
Gradient 1 in -25 Height 2m Lift BP
Locked Rail Cant -50mm

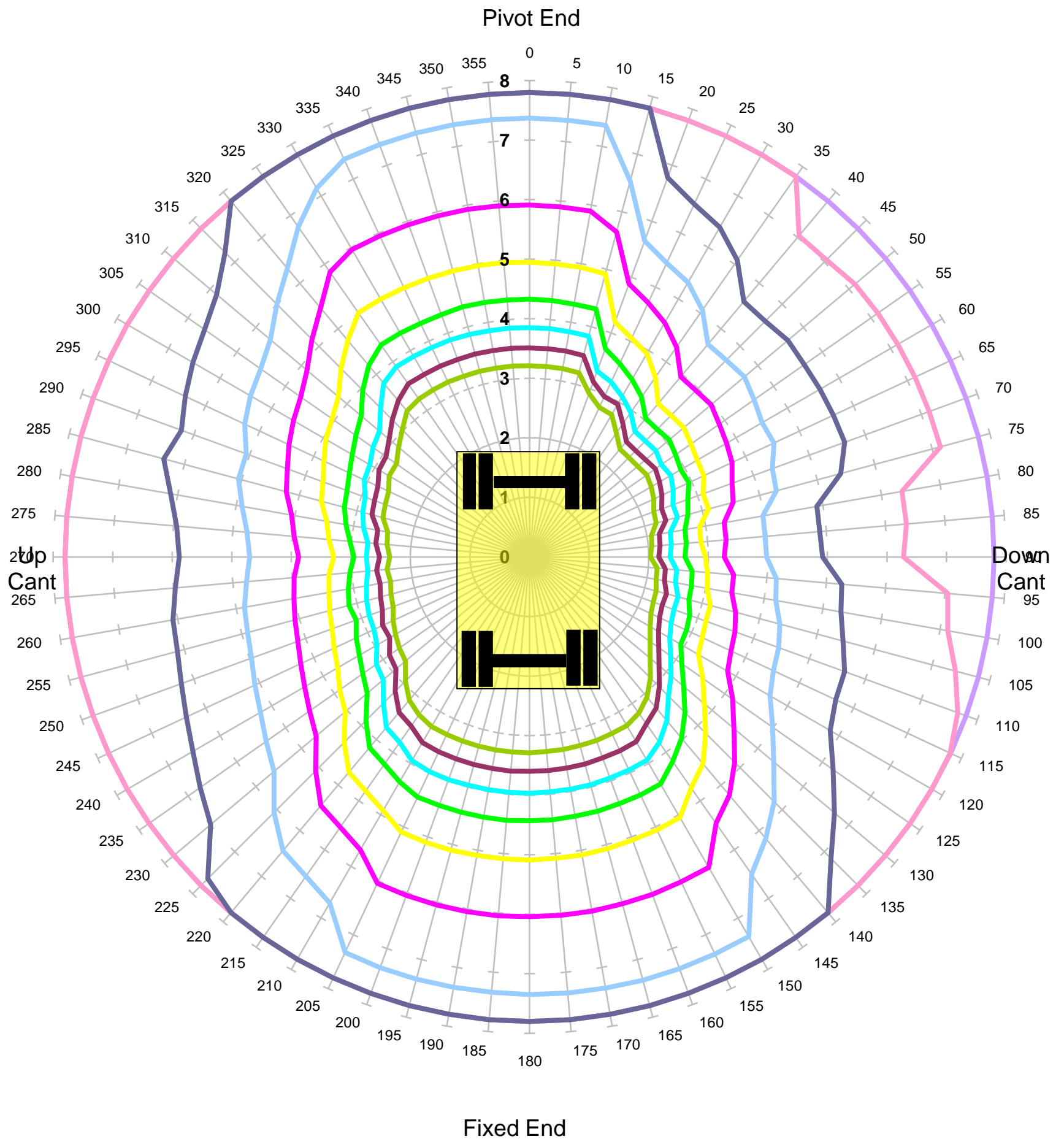

Units in Tonnes

- 1
- 2
- 3
- 4
- 5
- 6
- 7
- 8
- 9
- 10

MACHINE & MODEL:	Komatsu PW160-11	REFERENCE:	3.00m Jib
SERIAL No:	H65493	DATE OF CHART:	12-Sep-2022
EQUIPMENT:	2.00m + 3.47m + 2.50m	SAFETY FACTOR:	90.0%
COMMENT:			

Komatsu PW160-11
Max Capacity Contours of Radius(m) Plots 2.5m Dipper
Gradient 1 in -25 Height 2m Lift BP
Locked Rail Cant 50mm

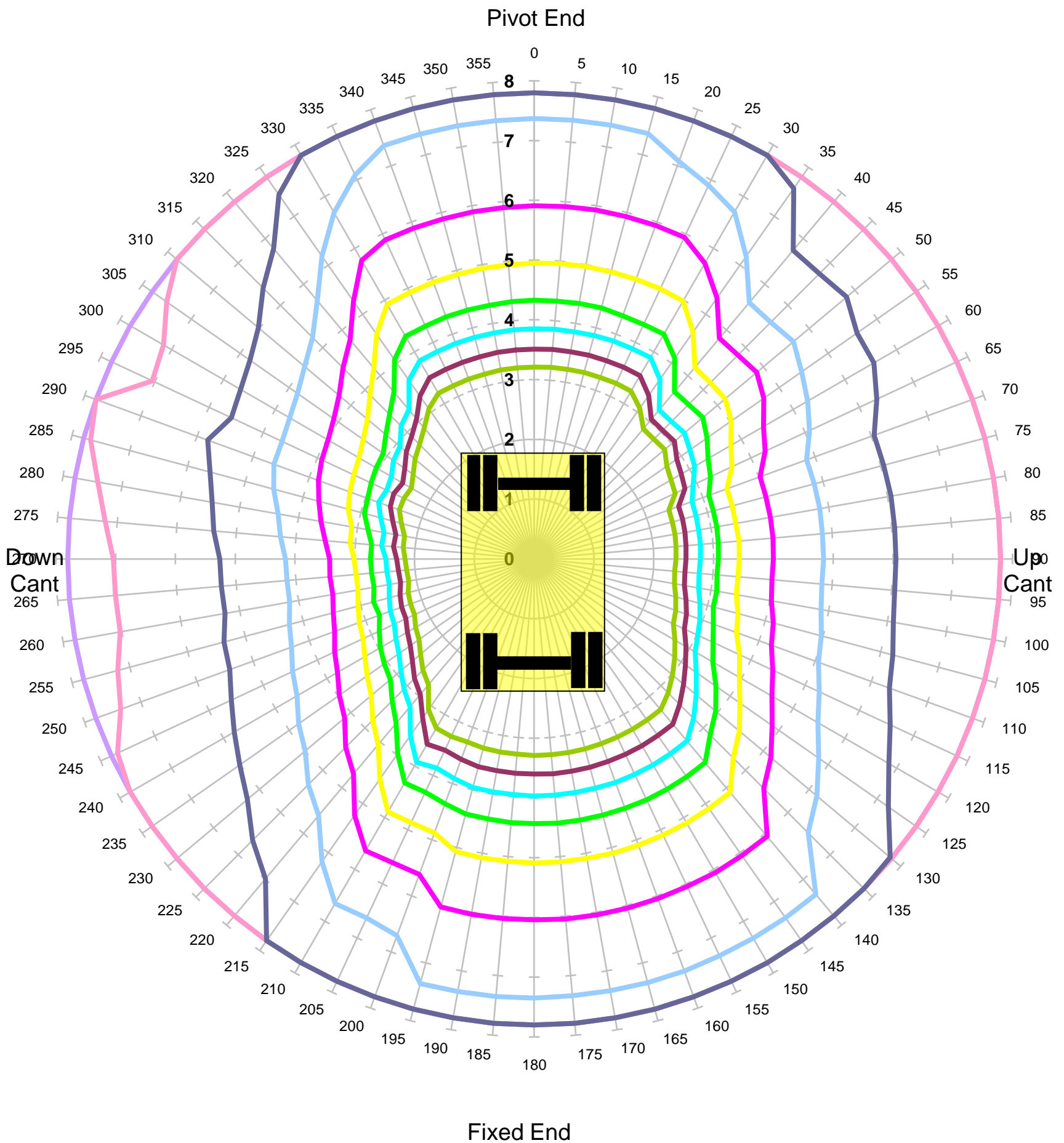

Units in Tonnes

- 1
- 2
- 3
- 4
- 5
- 6
- 7
- 8
- 9
- 10

MACHINE & MODEL:	Komatsu PW160-11	REFERENCE:	3.00m Jib
SERIAL No:	H65493	DATE OF CHART:	12-Sep-2022
EQUIPMENT:	2.00m + 3.47m + 2.50m	SAFETY FACTOR:	90.0%
COMMENT:			

Komatsu PW160-11
Max Capacity Contours of Radius(m) Plots 2.5m Dipper
Gradient 1 in -25 Height 2m Lift BP
Locked Rail Cant 150mm

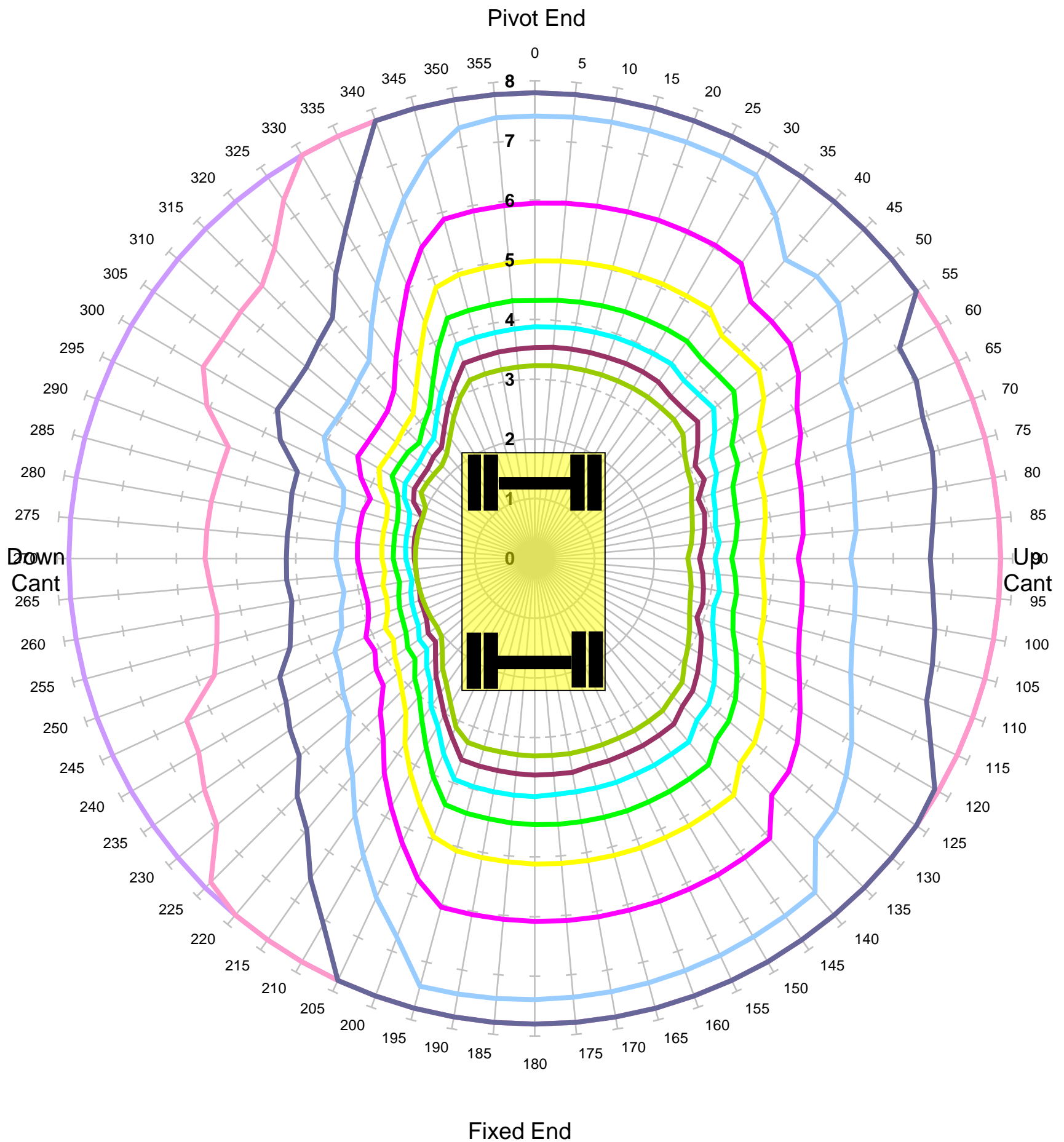

MACHINE & MODEL:	Komatsu PW160-11	REFERENCE:	3.00m Jib
SERIAL No:	H65493	DATE OF CHART:	12-Sep-2022
EQUIPMENT:	2.00m + 3.47m + 2.50m	SAFETY FACTOR:	90.0%
COMMENT:			

Komatsu PW160-11

**Max Capacity Contours of Radius(m) Plots 2.5m Dipper
Level Ground Height 2m Lift BP
Unlocked Road**

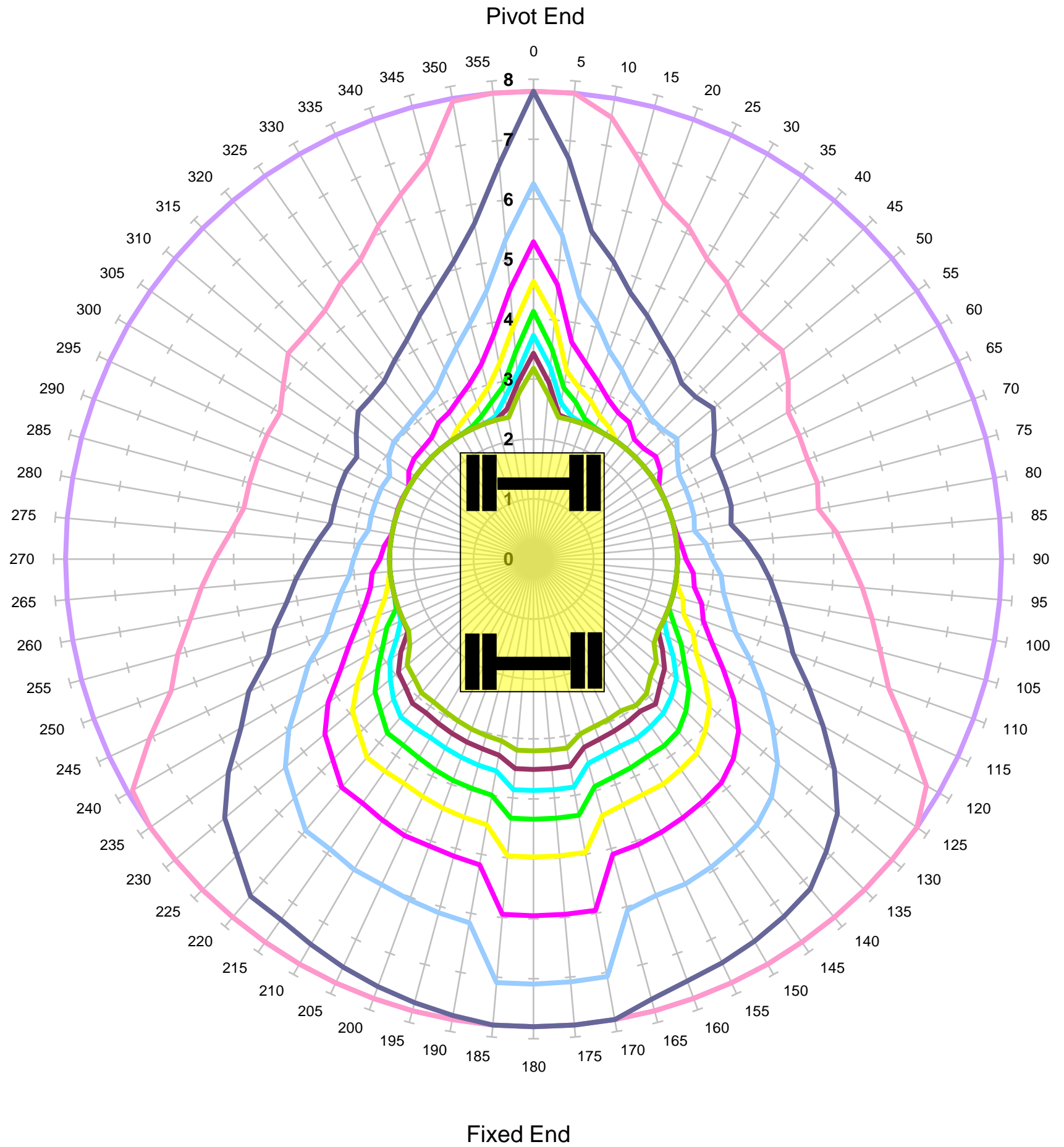

Units in Tonnes

- 1
- 2
- 3
- 4
- 5
- 6
- 7
- 8
- 9
- 10

MACHINE & MODEL:	Komatsu PW160-11	REFERENCE:	3.00m Jib
SERIAL No:	H65493	DATE OF CHART:	12-Sep-2022
EQUIPMENT:	2.00m + 3.47m + 2.50m	SAFETY FACTOR:	71.0%
COMMENT:			

Komatsu PW160-11
Max Capacity Contours of Radius(m) Plots 2.5m Dipper
Level Ground Height 2m Lift BP
Locked Road

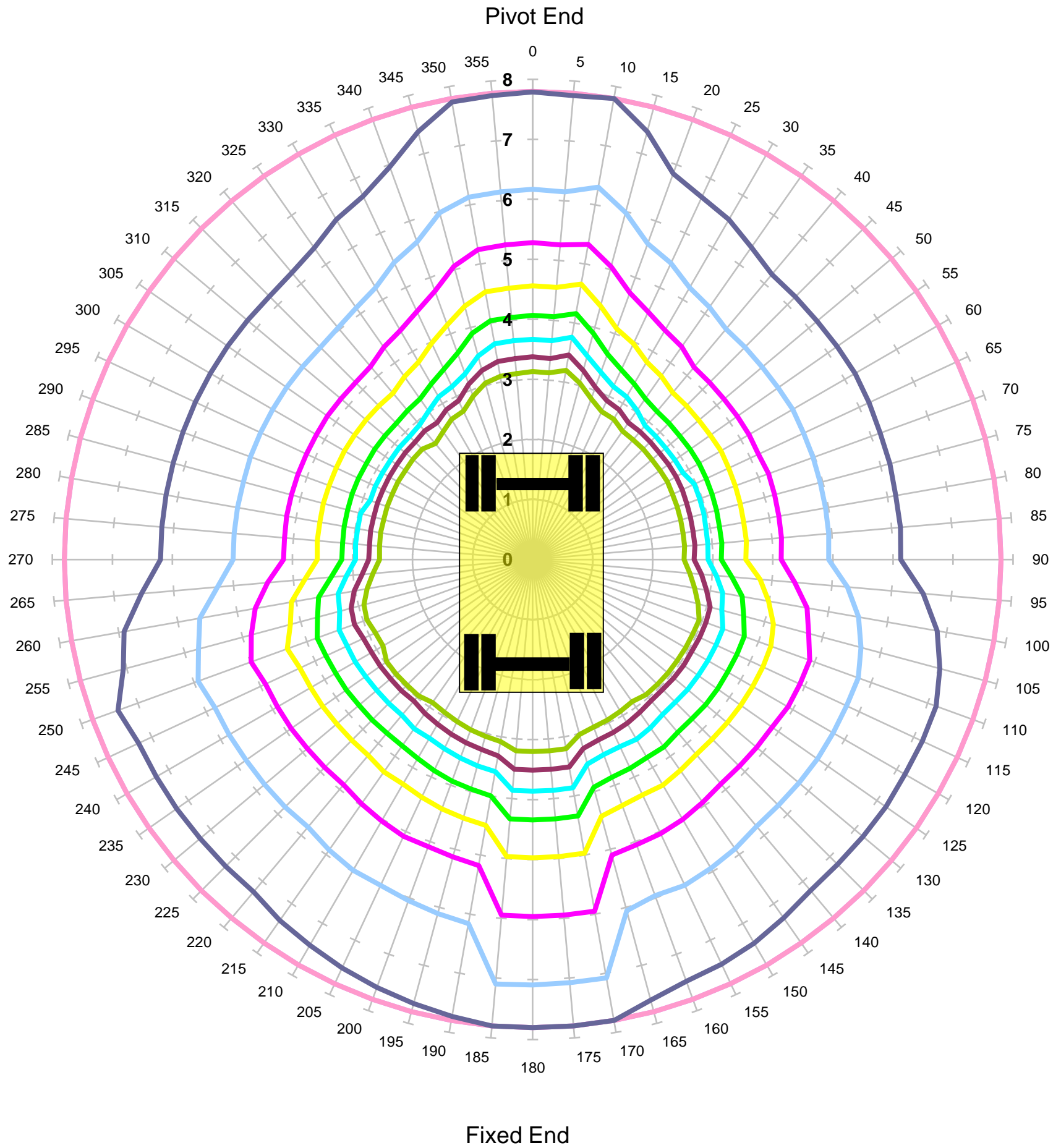

Units in Tonnes

- 1
- 2
- 3
- 4
- 5
- 6
- 7
- 8
- 9
- 10

MACHINE & MODEL:	Komatsu PW160-11	REFERENCE:	3.00m Jib
SERIAL No:	H65493	DATE OF CHART:	12-Sep-2022
EQUIPMENT:	2.00m + 3.47m + 2.50m	SAFETY FACTOR:	71.0%
COMMENT:			

Komatsu PW160-11

**Max Capacity Contours of Radius(m) Plots 2.5m Dipper
Gradient 1 in -25 Height 2m Lift BP**

Unlocked Rail Cant -150mm - Tandem Lift

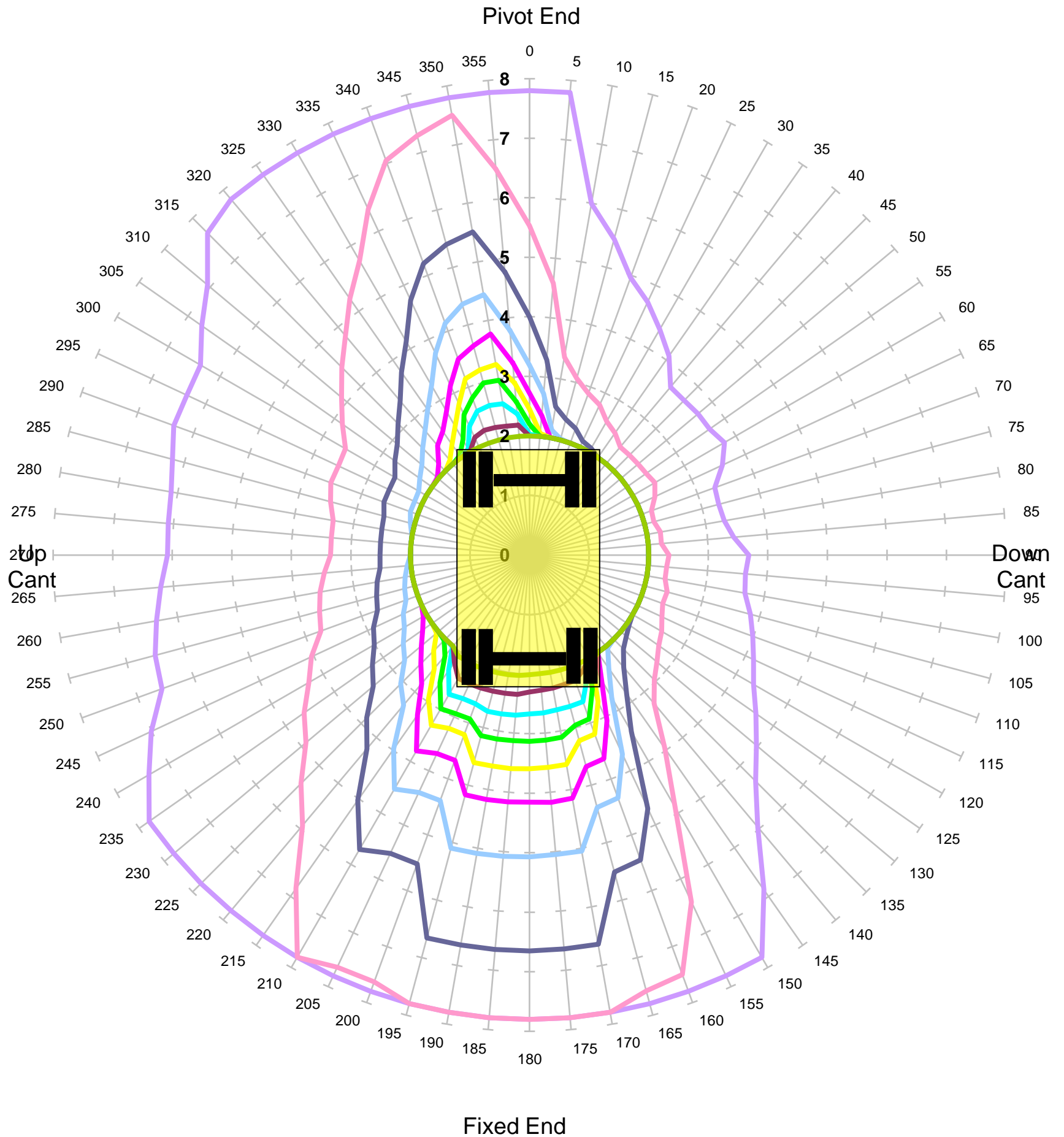

Units in Tonnes

- 1
- 2
- 3
- 4
- 5
- 6
- 7
- 8
- 9
- 10

MACHINE & MODEL:	Komatsu PW160-11	REFERENCE:	3.00m Jib
SERIAL No:	H65493	DATE OF CHART:	12-Sep-2022
EQUIPMENT:	2.00m + 3.47m + 2.50m	SAFETY FACTOR:	44.0%
COMMENT:			

Komatsu PW160-11

**Max Capacity Contours of Radius(m) Plots 2.5m Dipper
Gradient 1 in -25 Height 2m Lift BP
Unlocked Rail Cant -50mm - Tandem Lift**

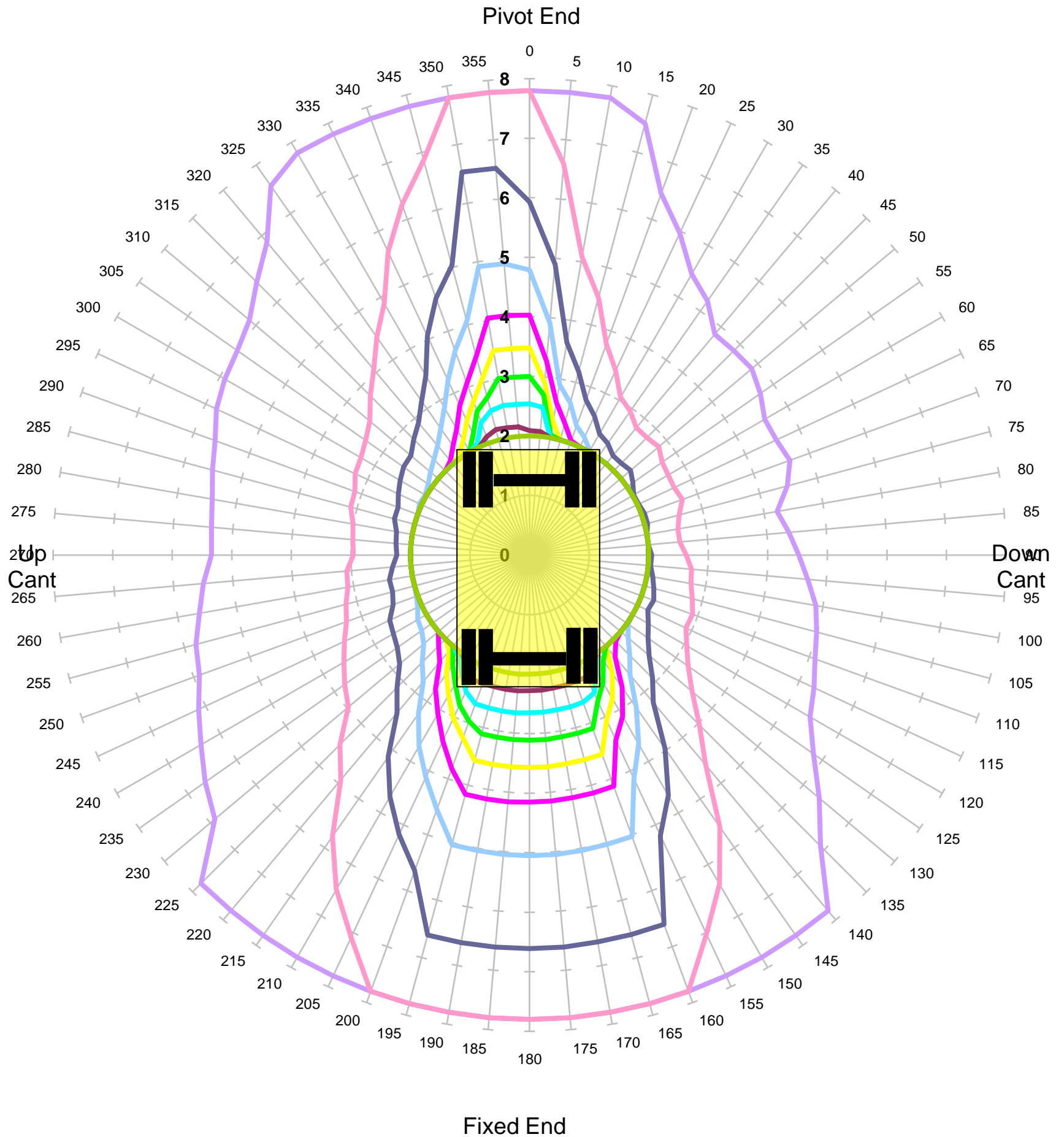

Units in Tonnes

- 1
- 2
- 3
- 4
- 5
- 6
- 7
- 8
- 9
- 10

MACHINE & MODEL:	Komatsu PW160-11	REFERENCE:	3.00m Jib
SERIAL No:	H65493	DATE OF CHART:	12-Sep-2022
EQUIPMENT:	2.00m + 3.47m + 2.50m	SAFETY FACTOR:	44.0%
COMMENT:			

Komatsu PW160-11

**Max Capacity Contours of Radius(m) Plots 2.5m Dipper
Gradient 1 in -25 Height 2m Lift BP
Unlocked Rail Cant 50mm - Tandem Lift**

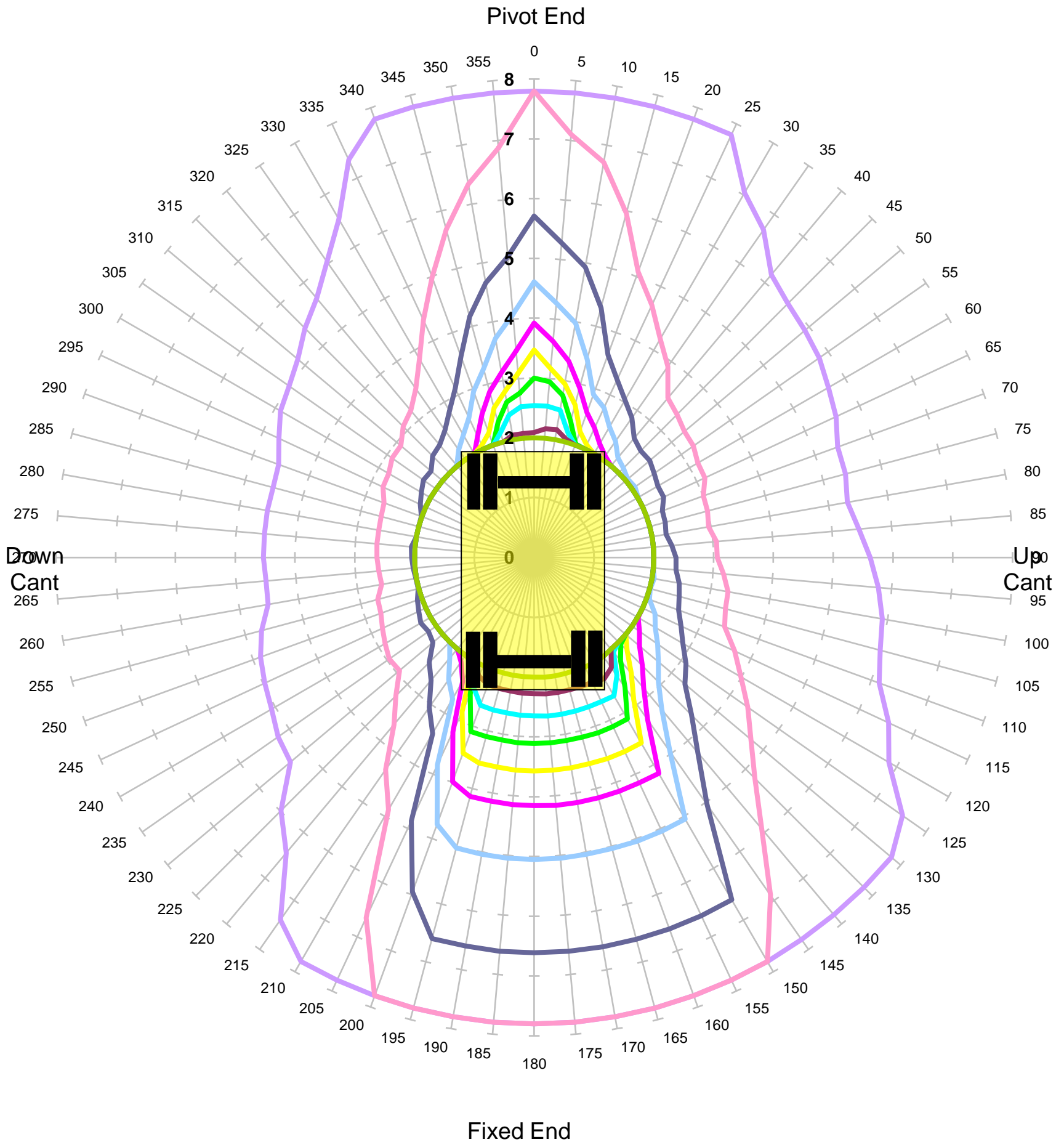

Units in Tonnes

- 1
- 2
- 3
- 4
- 5
- 6
- 7
- 8
- 9
- 10

MACHINE & MODEL:	Komatsu PW160-11	REFERENCE:	3.00m Jib
SERIAL No:	H65493	DATE OF CHART:	12-Sep-2022
EQUIPMENT:	2.00m + 3.47m + 2.50m	SAFETY FACTOR:	44.0%
COMMENT:			

Komatsu PW160-11

**Max Capacity Contours of Radius(m) Plots 2.5m Dipper
Gradient 1 in -25 Height 2m Lift BP**

Unlocked Rail Cant 150mm - Tandem Lift

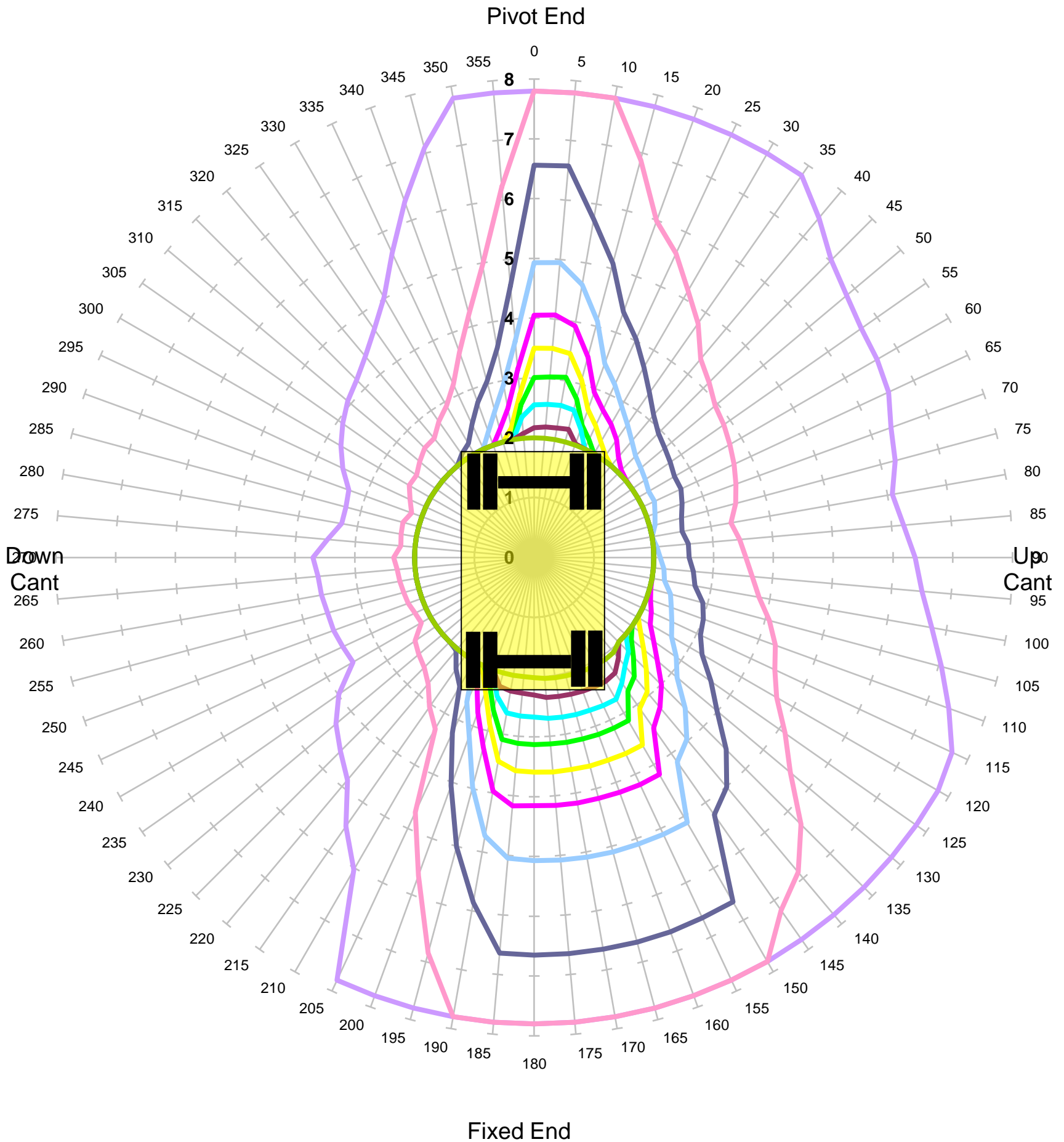

Units in Tonnes

- 1
- 2
- 3
- 4
- 5
- 6
- 7
- 8
- 9
- 10

MACHINE & MODEL:	Komatsu PW160-11	REFERENCE:	3.00m Jib
SERIAL No:	H65493	DATE OF CHART:	12-Sep-2022
EQUIPMENT:	2.00m + 3.47m + 2.50m	SAFETY FACTOR:	44.0%
COMMENT:			

Komatsu PW160-11

**Max Capacity Contours of Radius(m) Plots 2.5m Dipper
Gradient 1 in -25 Height 2m Lift BP
Locked Rail Cant -150mm - Tandem Lift**

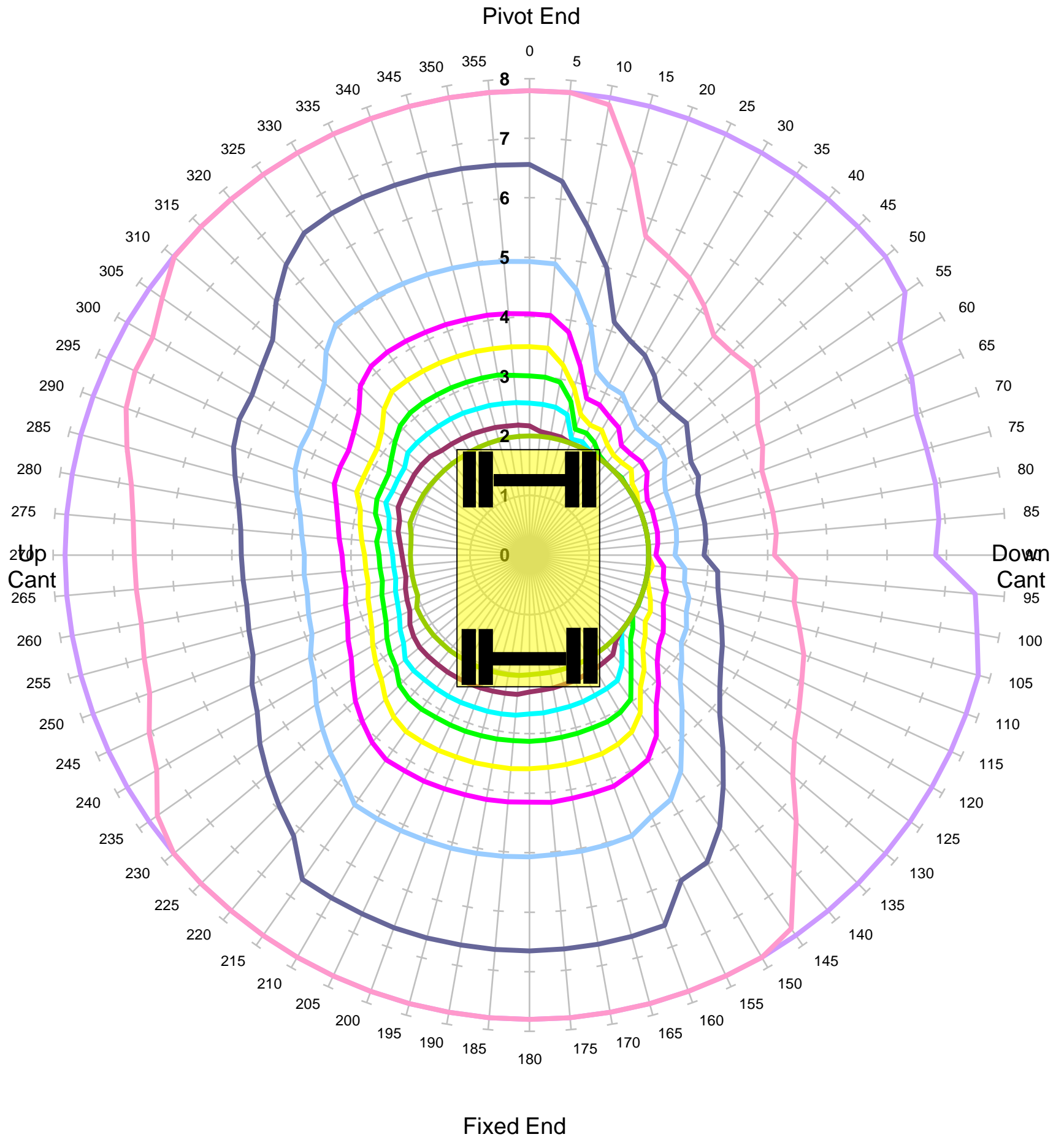

Units in Tonnes

- 1
- 2
- 3
- 4
- 5
- 6
- 7
- 8
- 9
- 10

MACHINE & MODEL:	Komatsu PW160-11	REFERENCE:	3.00m Jib
SERIAL No:	H65493	DATE OF CHART:	12-Sep-2022
EQUIPMENT:	2.00m + 3.47m + 2.50m	SAFETY FACTOR:	59.0%
COMMENT:			

Komatsu PW160-11

**Max Capacity Contours of Radius(m) Plots 2.5m Dipper
Gradient 1 in -25 Height 2m Lift BP
Locked Rail Cant -50mm - Tandem Lift**

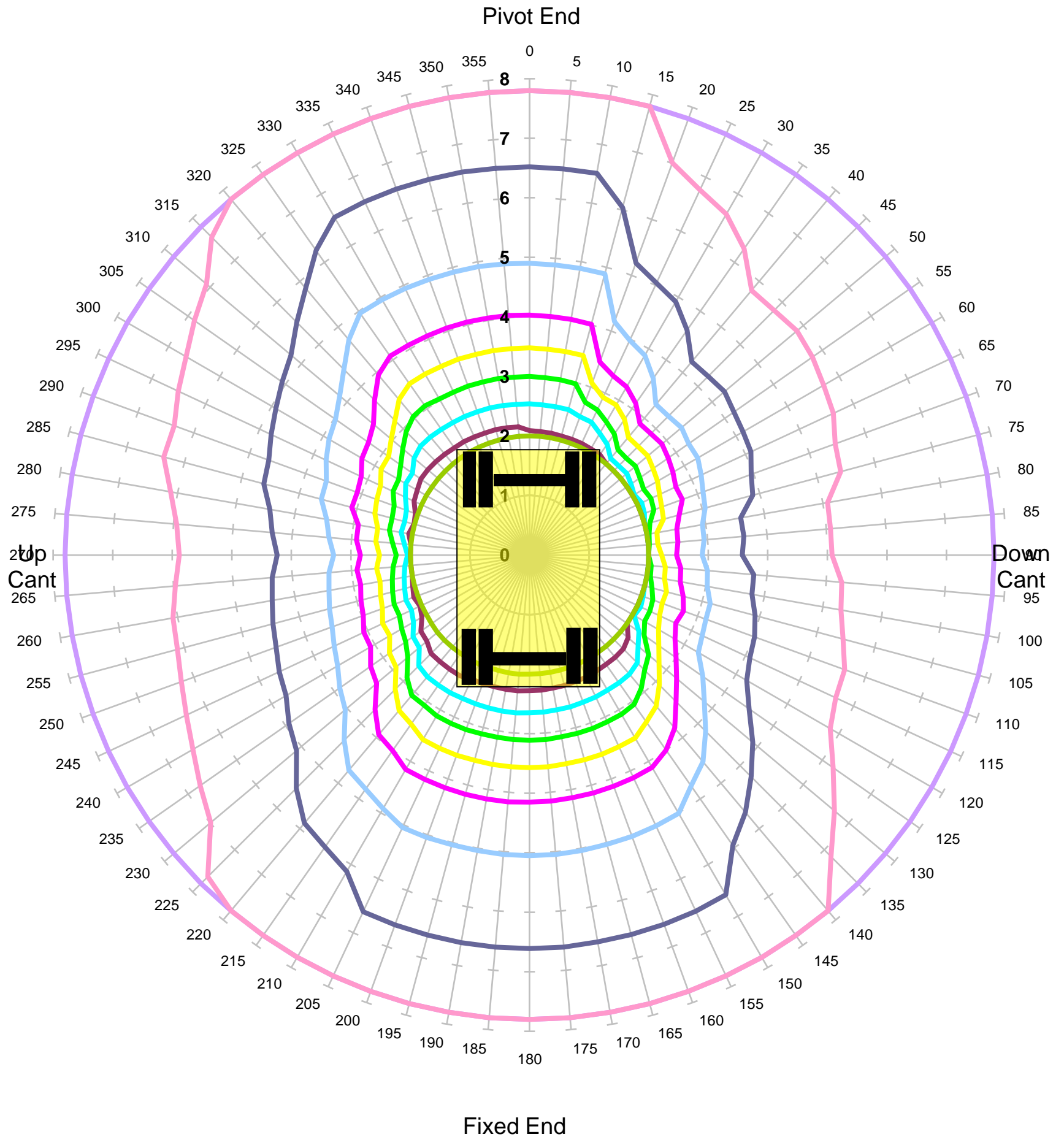

Units in Tonnes

- 1
- 2
- 3
- 4
- 5
- 6
- 7
- 8
- 9
- 10

MACHINE & MODEL:	Komatsu PW160-11	REFERENCE:	3.00m Jib
SERIAL No:	H65493	DATE OF CHART:	12-Sep-2022
EQUIPMENT:	2.00m + 3.47m + 2.50m	SAFETY FACTOR:	59.0%
COMMENT:			

Komatsu PW160-11

**Max Capacity Contours of Radius(m) Plots 2.5m Dipper
Gradient 1 in -25 Height 2m Lift BP
Locked Rail Cant 50mm - Tandem Lift**

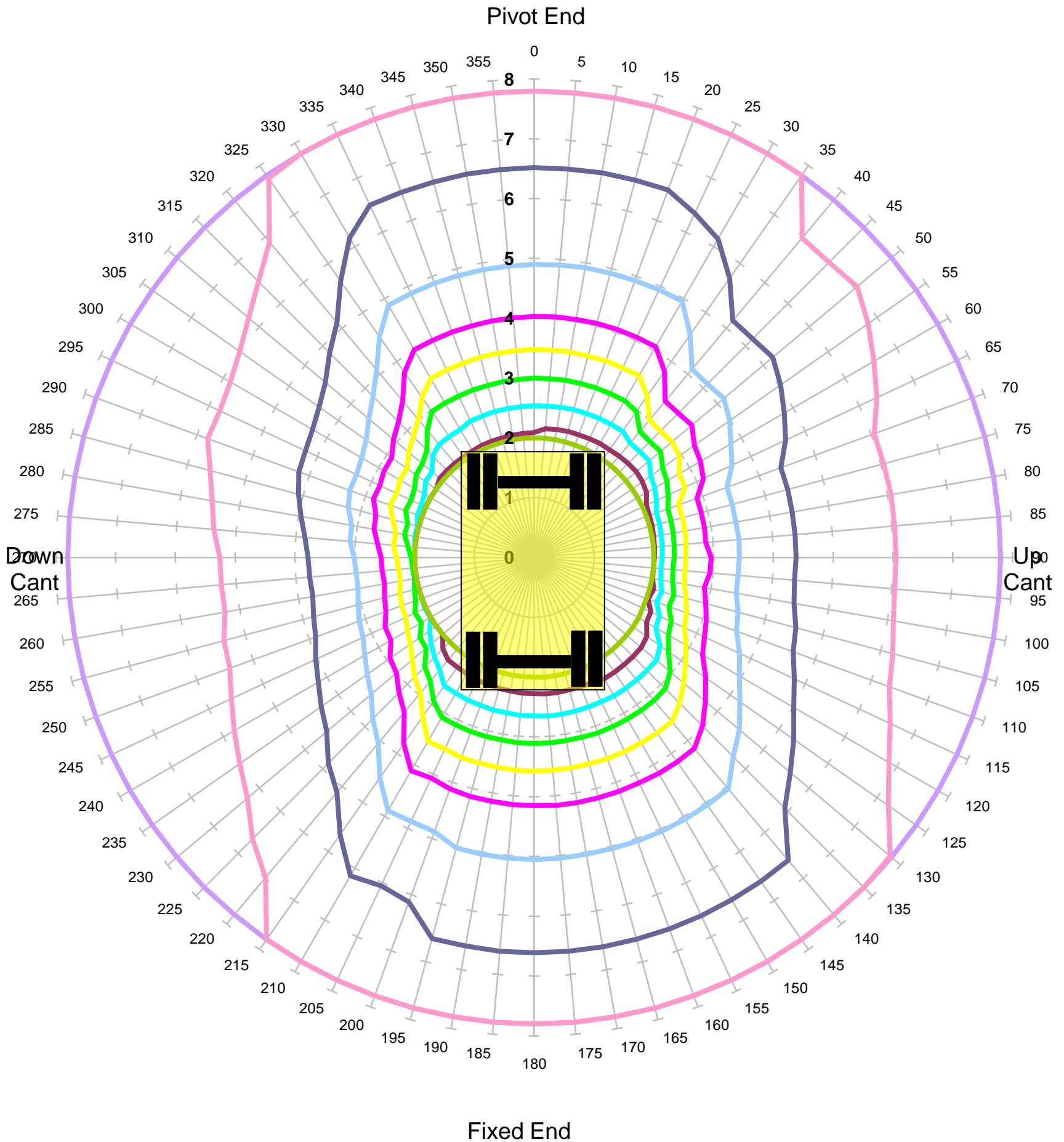

Units in Tonnes

- 1
- 2
- 3
- 4
- 5
- 6
- 7
- 8
- 9
- 10

MACHINE & MODEL:	Komatsu PW160-11	REFERENCE:	3.00m Jib
SERIAL No:	H65493	DATE OF CHART:	12-Sep-2022
EQUIPMENT:	2.00m + 3.47m + 2.50m	SAFETY FACTOR:	59.0%
COMMENT:			

Komatsu PW160-11

**Max Capacity Contours of Radius(m) Plots 2.5m Dipper
Gradient 1 in -25 Height 2m Lift BP
Locked Rail Cant 150mm - Tandem Lift**

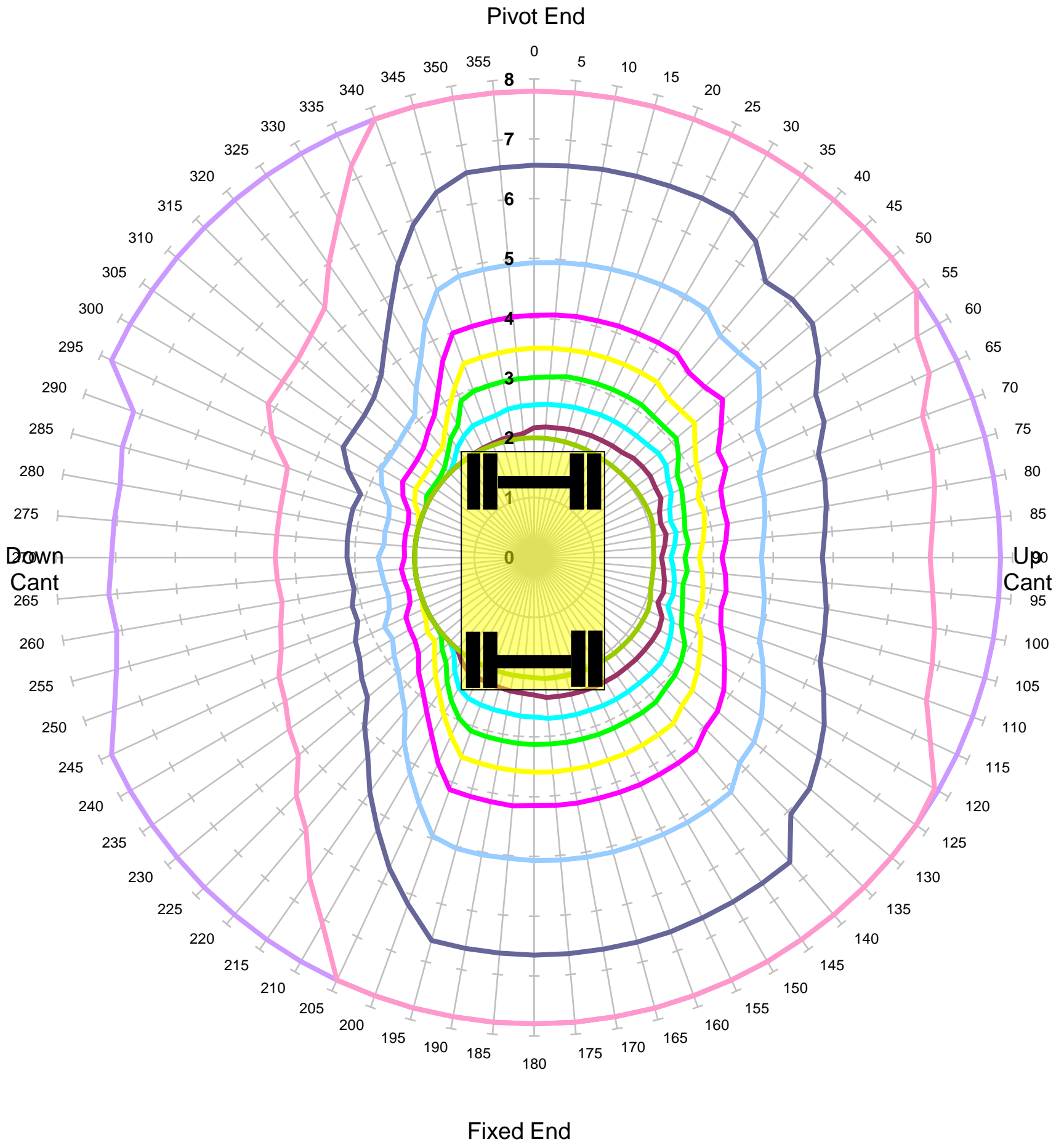

Units in Tonnes

- 1
- 2
- 3
- 4
- 5
- 6
- 7
- 8
- 9
- 10

MACHINE & MODEL:	Komatsu PW160-11	REFERENCE:	3.00m Jib
SERIAL No:	H65493	DATE OF CHART:	12-Sep-2022
EQUIPMENT:	2.00m + 3.47m + 2.50m	SAFETY FACTOR:	59.0%
COMMENT:			

Komatsu PW160-11
Max Capacity Contours of Radius(m) Plots 2.5m Dipper
Level Ground Height 2m Lift BP
Unlocked Road - Tandem Lift

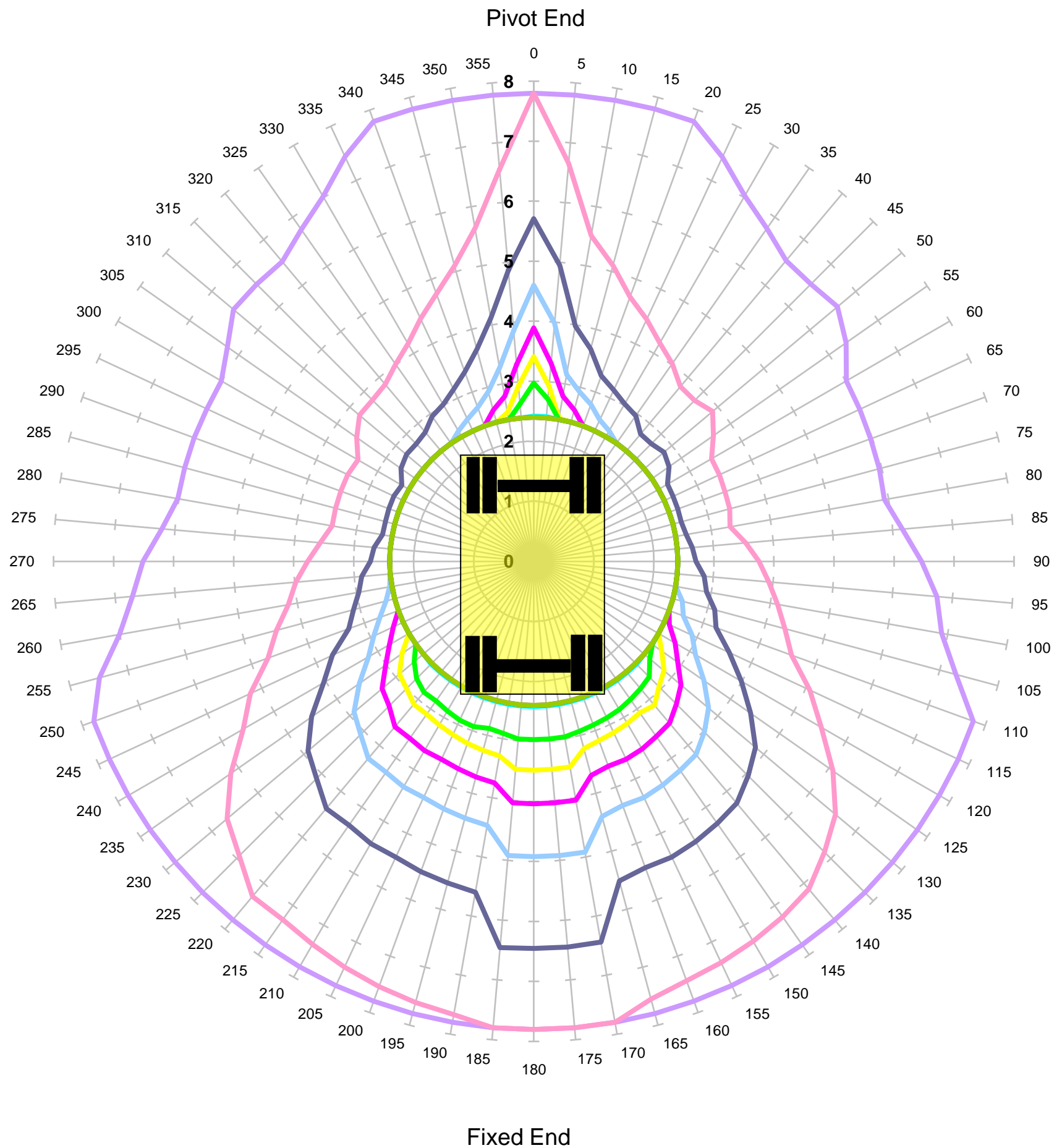

Units in Tonnes

- 1
- 2
- 3
- 4
- 5
- 6
- 7
- 8
- 9
- 10

MACHINE & MODEL:	Komatsu PW160-11	REFERENCE:	3.00m Jib
SERIAL No:	H65493	DATE OF CHART:	12-Sep-2022
EQUIPMENT:	2.00m + 3.47m + 2.50m	SAFETY FACTOR:	47.0%
COMMENT:			

Komatsu PW160-11
Max Capacity Contours of Radius(m) Plots 2.5m Dipper
Level Ground Height 2m Lift BP
Locked Road - Tandem Lift

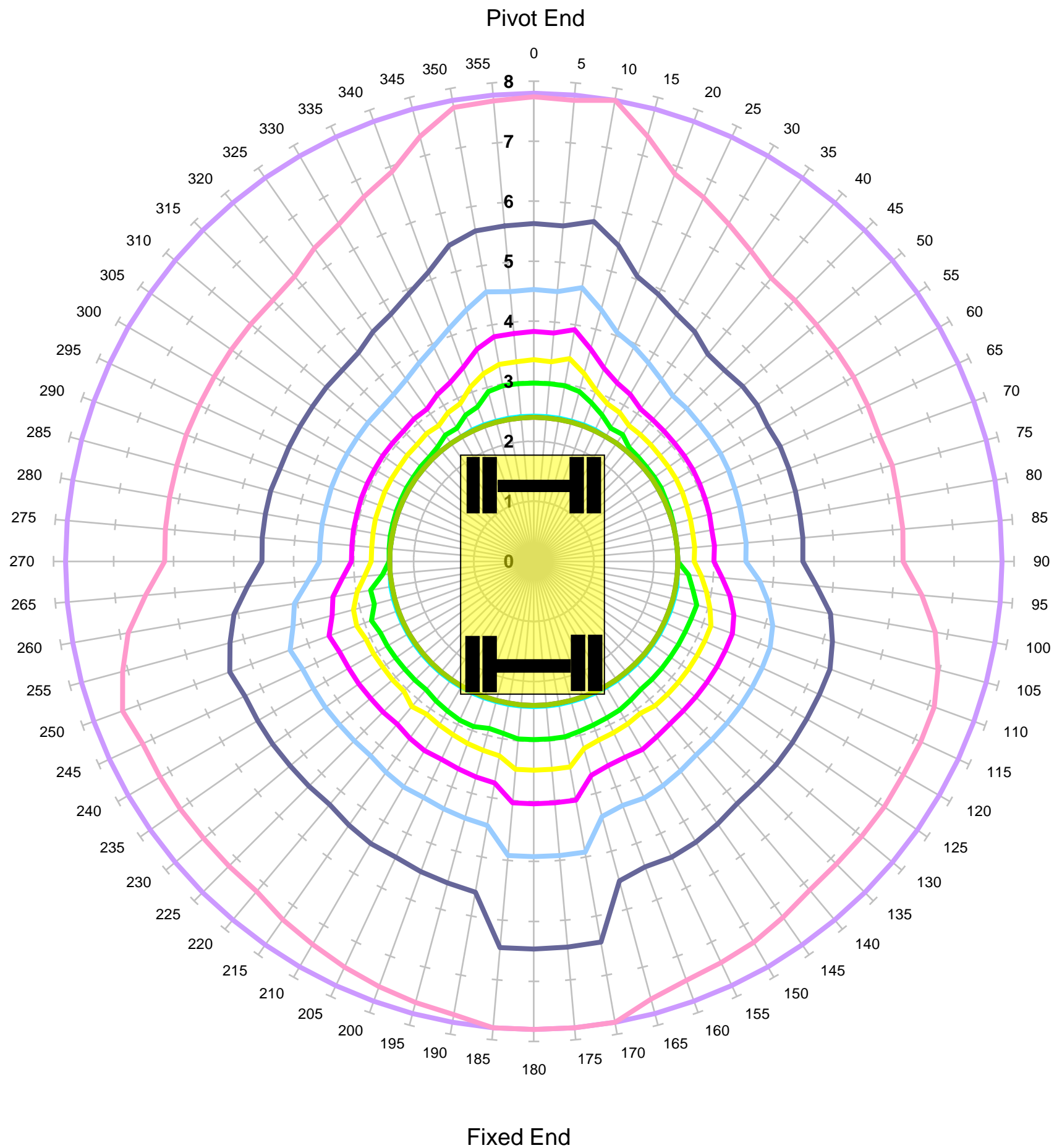

Units in Tonnes

- 1
- 2
- 3
- 4
- 5
- 6
- 7
- 8
- 9
- 10

MACHINE & MODEL:	Komatsu PW160-11	REFERENCE:	3.00m Jib
SERIAL No:	H65493	DATE OF CHART:	12-Sep-2022
EQUIPMENT:	2.00m + 3.47m + 2.50m	SAFETY FACTOR:	47.0%
COMMENT:			

Komatsu PW160-11
Max Capacity Contours of Radius(m) Plots 2.5m Dipper
Gradient 1 in -25 Height 2m Lift ALP1
Unlocked Rail Cant -150mm

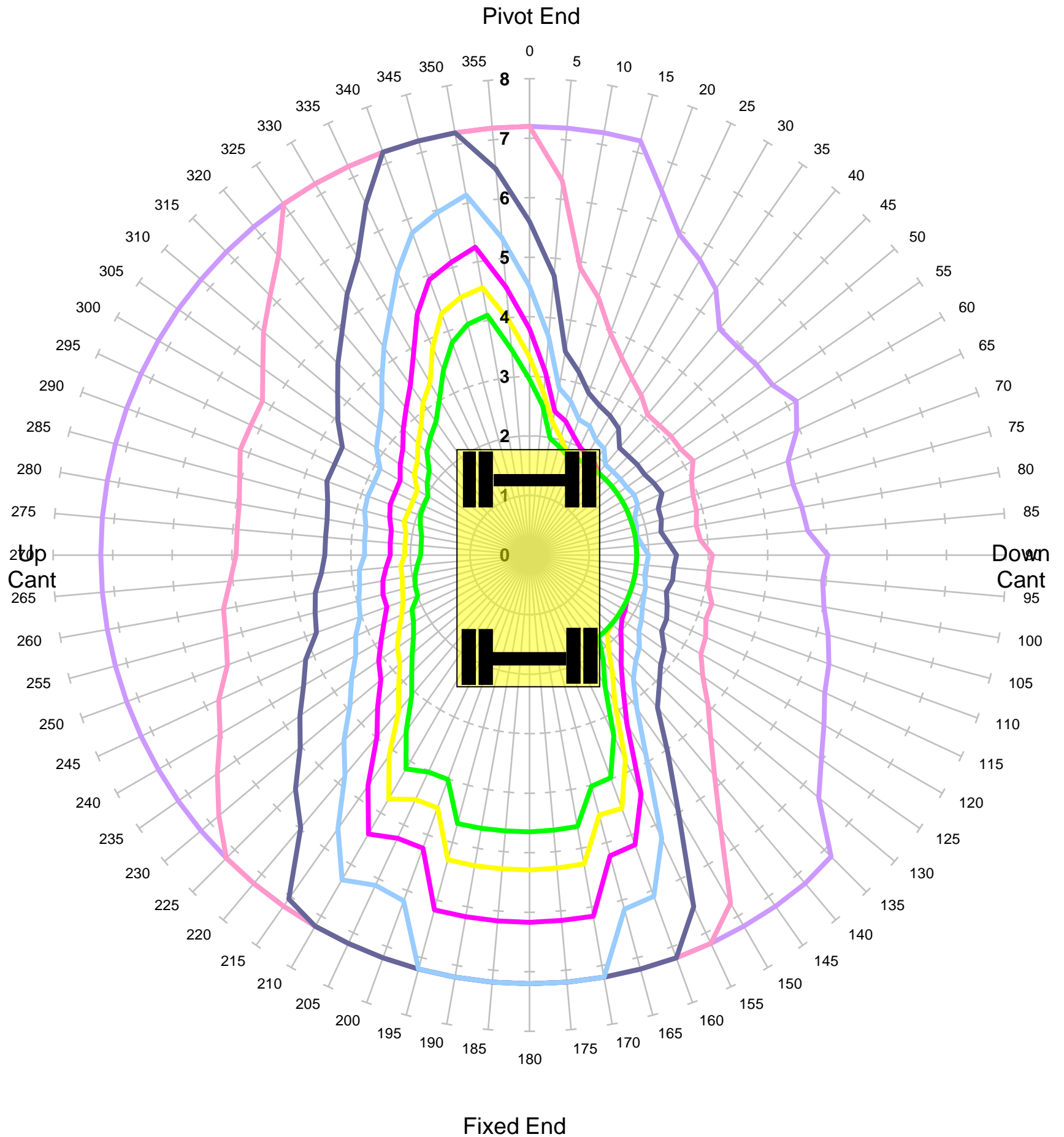

Units in Tonnes

- 1
- 2
- 3
- 4
- 5
- 6
- 7

MACHINE & MODEL:	Komatsu PW160-11	REFERENCE:	3.00m Jib
SERIAL No:	H65493	DATE OF CHART:	12-Sep-2022
EQUIPMENT:	2.00m + 3.47m + 2.50m	SAFETY FACTOR:	67.0%
COMMENT:			

Komatsu PW160-11
Max Capacity Contours of Radius(m) Plots 2.5m Dipper
Gradient 1 in -25 Height 2m Lift ALP1
Unlocked Rail Cant -50mm

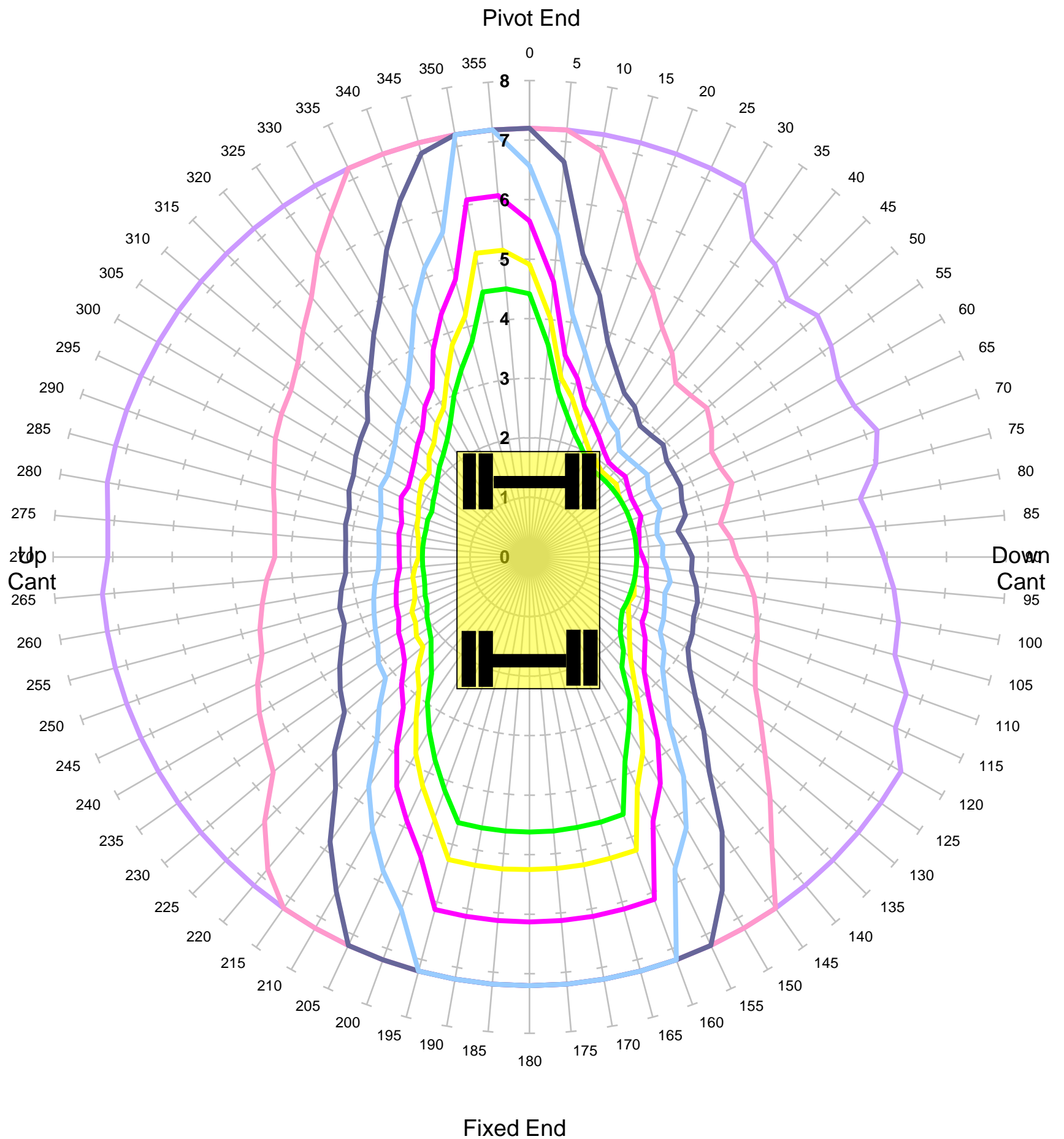

Units in Tonnes

- 1
- 2
- 3
- 4
- 5
- 6
- 7

MACHINE & MODEL:	Komatsu PW160-11	REFERENCE:	3.00m Jib
SERIAL No:	H65493	DATE OF CHART:	12-Sep-2022
EQUIPMENT:	2.00m + 3.47m + 2.50m	SAFETY FACTOR:	67.0%
COMMENT:			

Komatsu PW160-11
Max Capacity Contours of Radius(m) Plots 2.5m Dipper
Gradient 1 in -25 Height 2m Lift ALP1
Unlocked Rail Cant 50mm

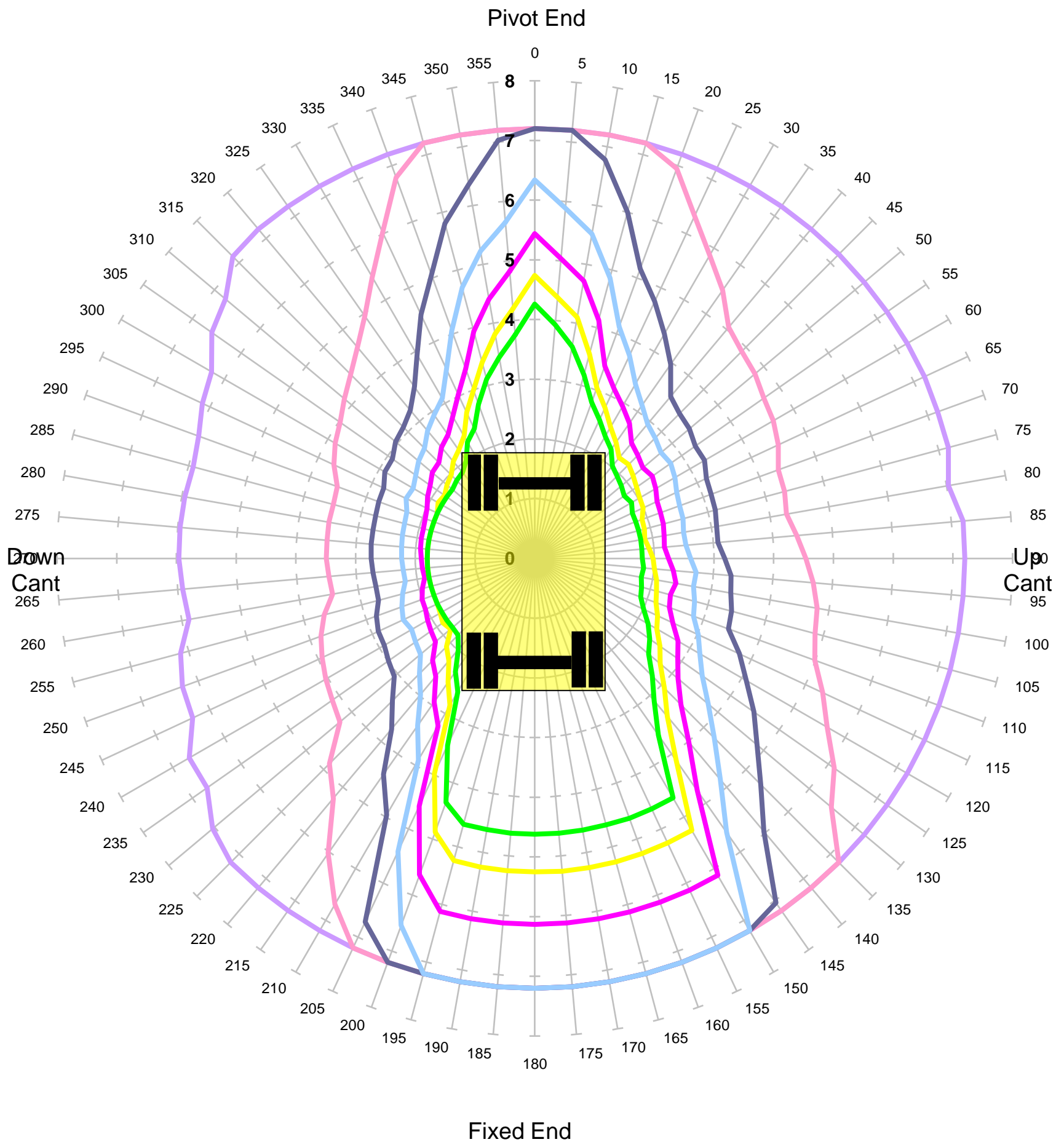

Units in Tonnes

- 1
- 2
- 3
- 4
- 5
- 6
- 7

MACHINE & MODEL:	Komatsu PW160-11	REFERENCE:	3.00m Jib
SERIAL No:	H65493	DATE OF CHART:	12-Sep-2022
EQUIPMENT:	2.00m + 3.47m + 2.50m	SAFETY FACTOR:	67.0%
COMMENT:			

Komatsu PW160-11
Max Capacity Contours of Radius(m) Plots 2.5m Dipper
Gradient 1 in -25 Height 2m Lift ALP1
Unlocked Rail Cant 150mm

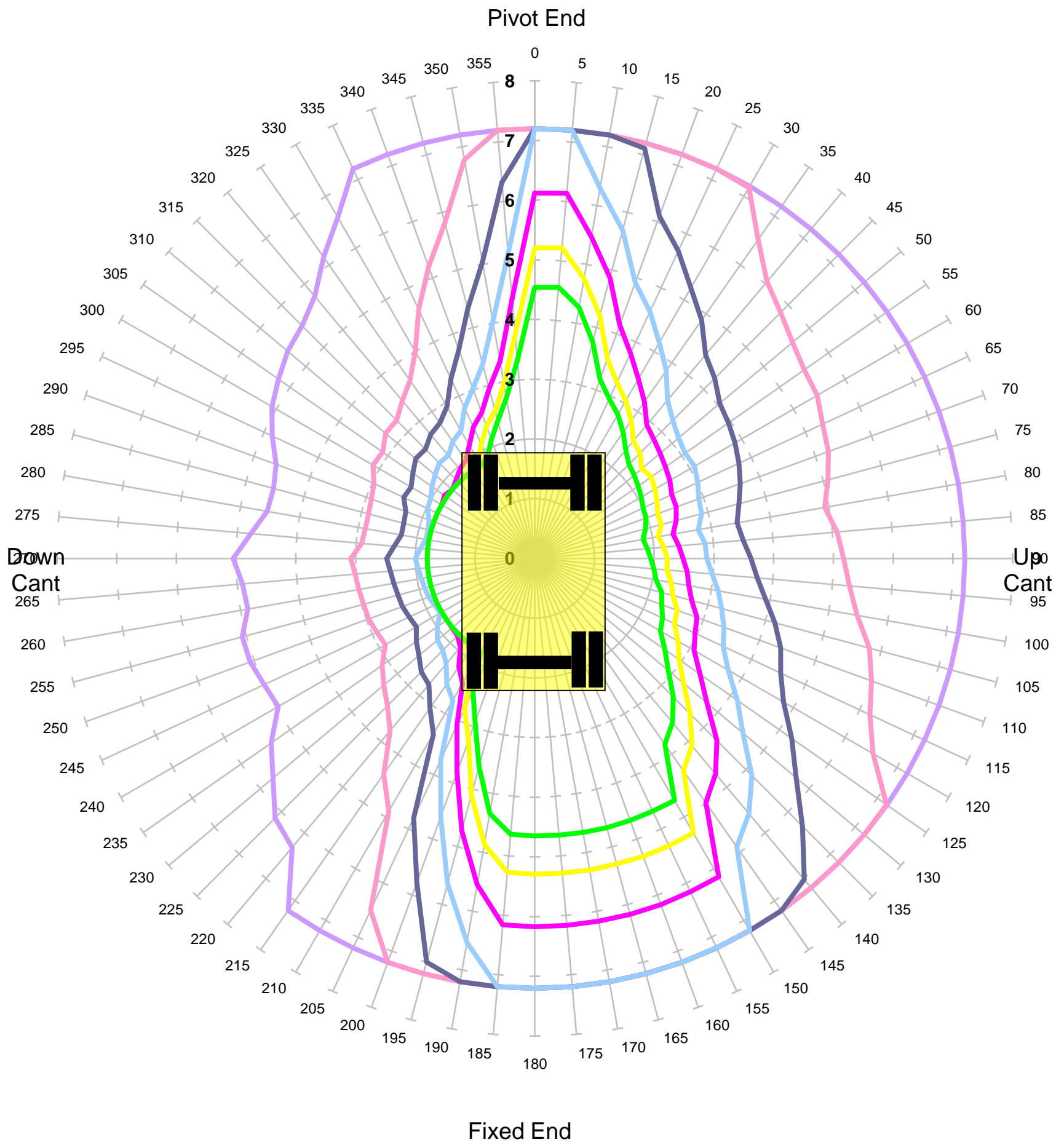

Units in Tonnes

- 1
- 2
- 3
- 4
- 5
- 6
- 7

MACHINE & MODEL:	Komatsu PW160-11	REFERENCE:	3.00m Jib
SERIAL No:	H65493	DATE OF CHART:	12-Sep-2022
EQUIPMENT:	2.00m + 3.47m + 2.50m	SAFETY FACTOR:	67.0%
COMMENT:			

Komatsu PW160-11
Max Capacity Contours of Radius(m) Plots 2.5m Dipper
Gradient 1 in -25 Height 2m Lift ALP1
Locked Rail Cant -150mm

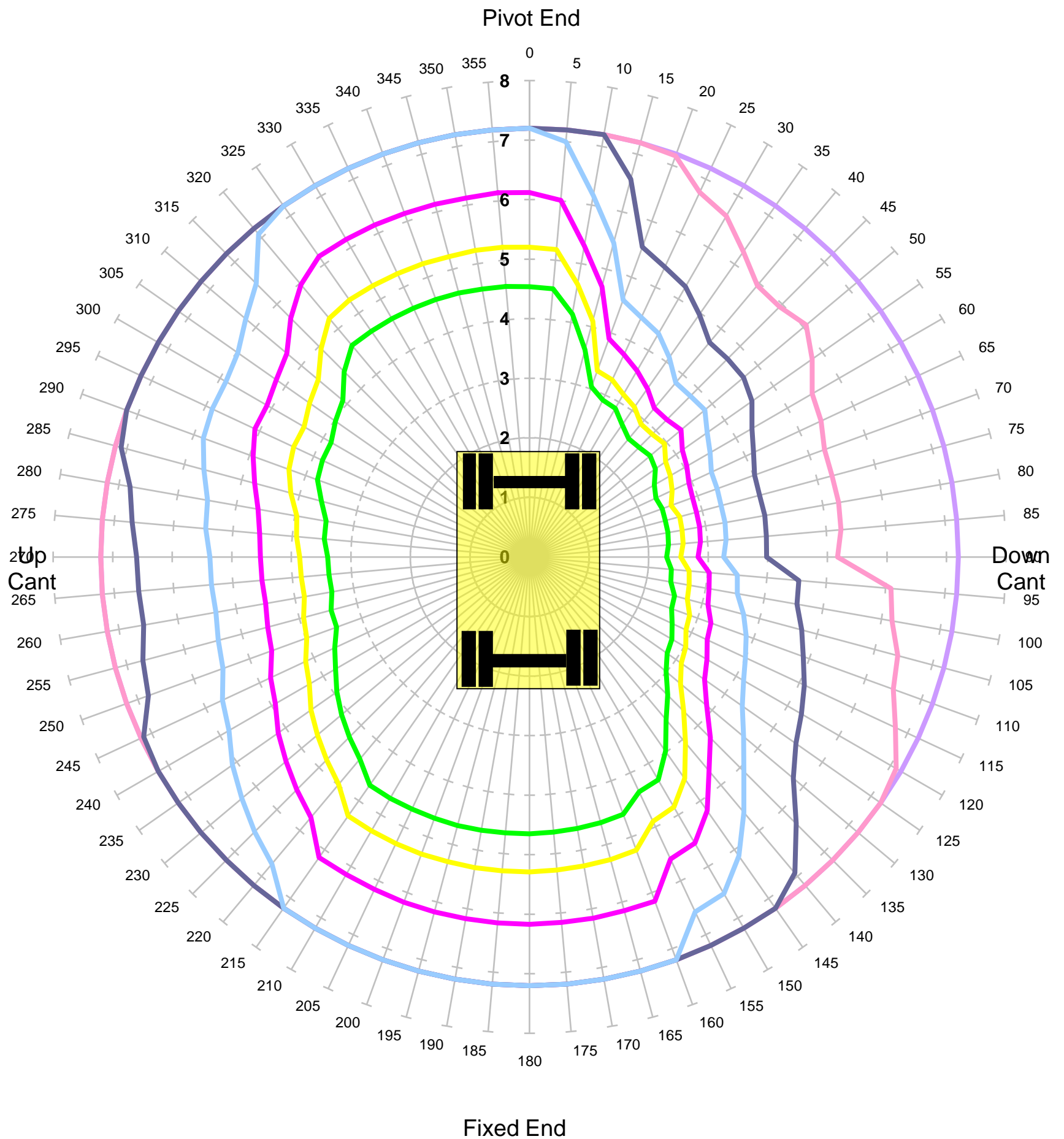

Units in Tonnes

- 1
- 2
- 3
- 4
- 5
- 6
- 7

MACHINE & MODEL:	Komatsu PW160-11	REFERENCE:	3.00m Jib
SERIAL No:	H65493	DATE OF CHART:	12-Sep-2022
EQUIPMENT:	2.00m + 3.47m + 2.50m	SAFETY FACTOR:	90.0%
COMMENT:			

Komatsu PW160-11
Max Capacity Contours of Radius(m) Plots 2.5m Dipper
Gradient 1 in -25 Height 2m Lift ALP1
Locked Rail Cant -50mm

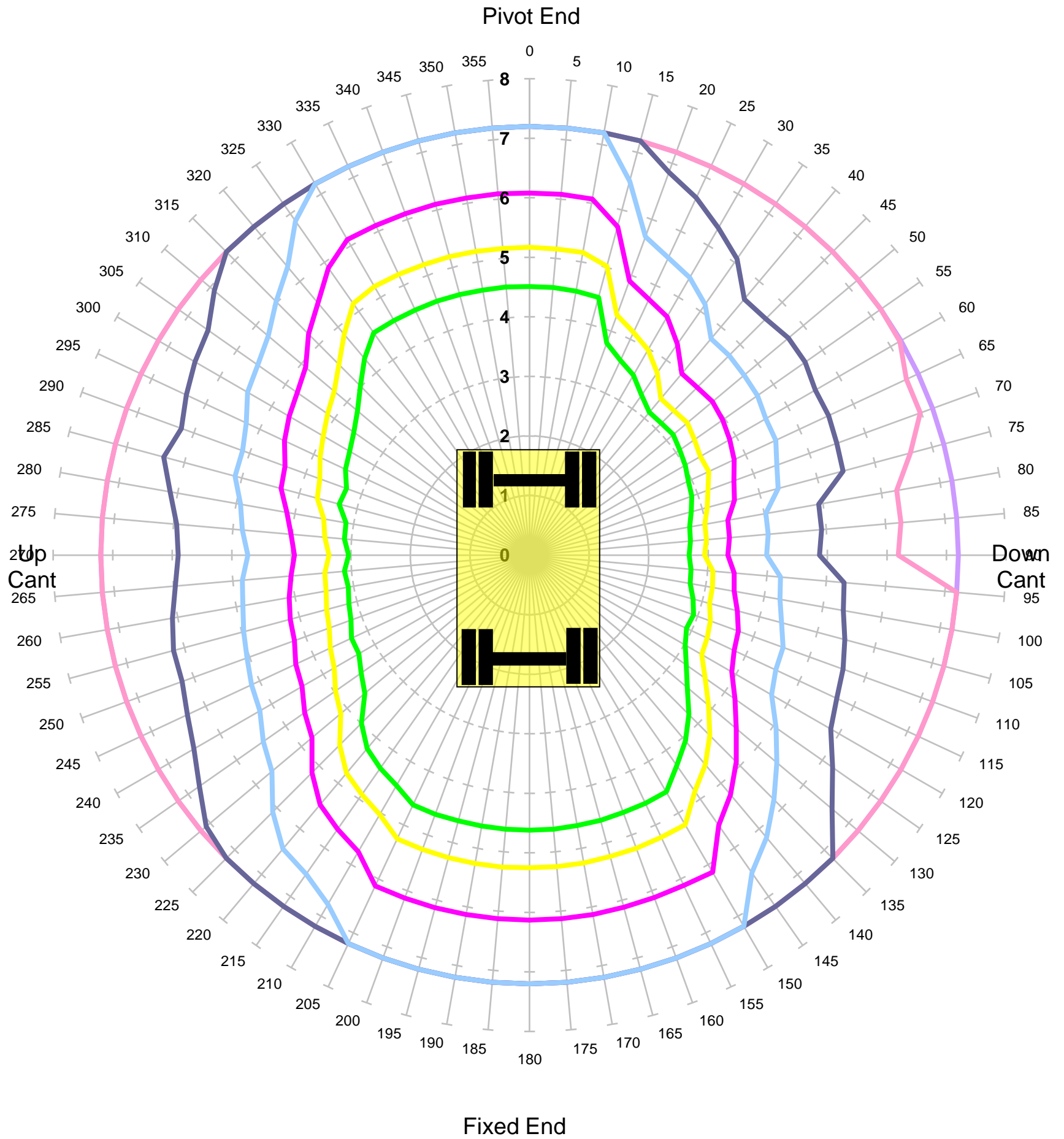

MACHINE & MODEL:	Komatsu PW160-11	REFERENCE:	3.00m Jib
SERIAL No:	H65493	DATE OF CHART:	12-Sep-2022
EQUIPMENT:	2.00m + 3.47m + 2.50m	SAFETY FACTOR:	90.0%
COMMENT:			

Komatsu PW160-11
Max Capacity Contours of Radius(m) Plots 2.5m Dipper
Gradient 1 in -25 Height 2m Lift ALP1
Locked Rail Cant 50mm

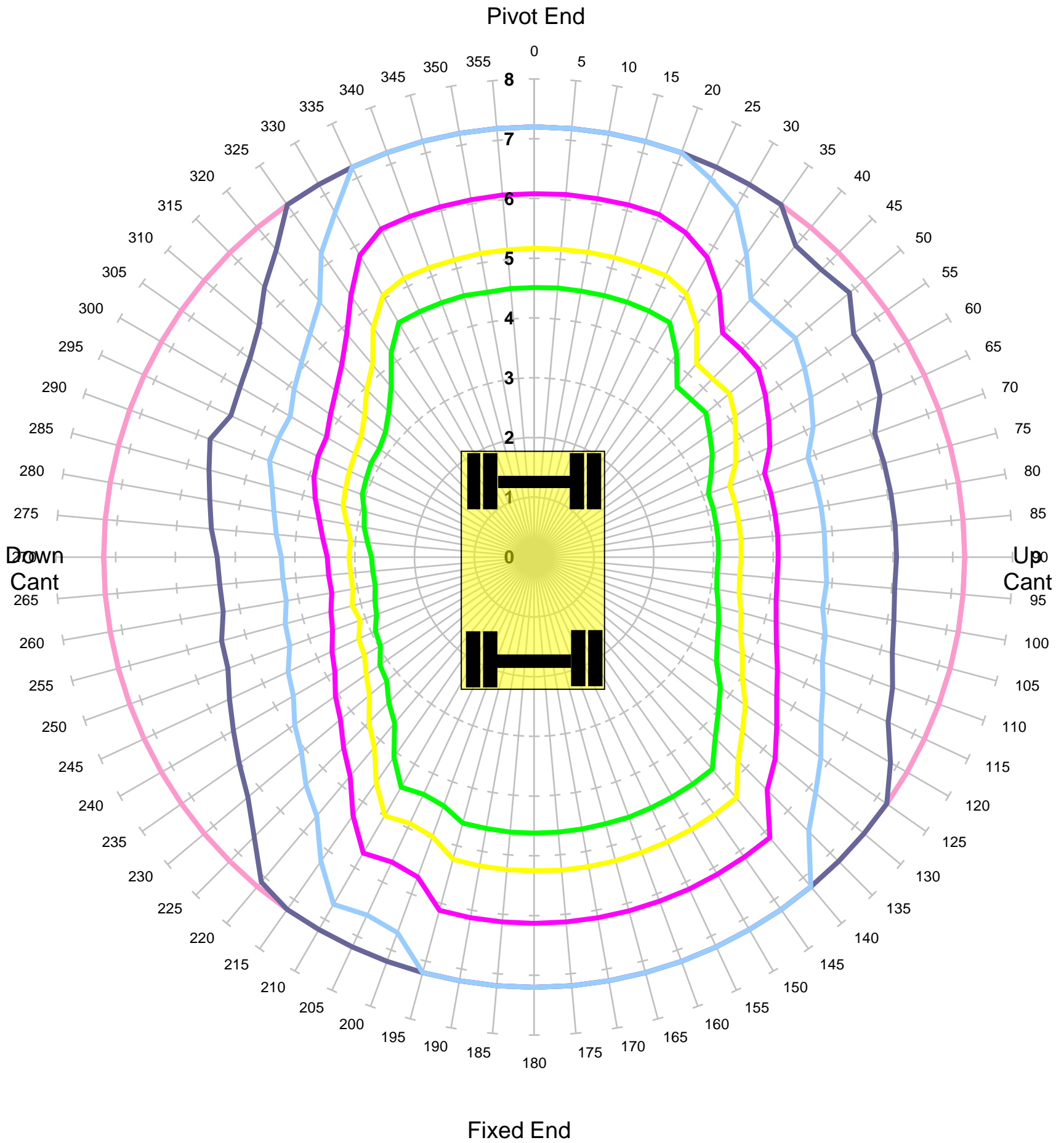

Units in Tonnes

- 1
- 2
- 3
- 4
- 5
- 6
- 7

MACHINE & MODEL:	Komatsu PW160-11	REFERENCE:	3.00m Jib
SERIAL No:	H65493	DATE OF CHART:	12-Sep-2022
EQUIPMENT:	2.00m + 3.47m + 2.50m	SAFETY FACTOR:	90.0%
COMMENT:			

Komatsu PW160-11
Max Capacity Contours of Radius(m) Plots 2.5m Dipper
Gradient 1 in -25 Height 2m Lift ALP1
Locked Rail Cant 150mm

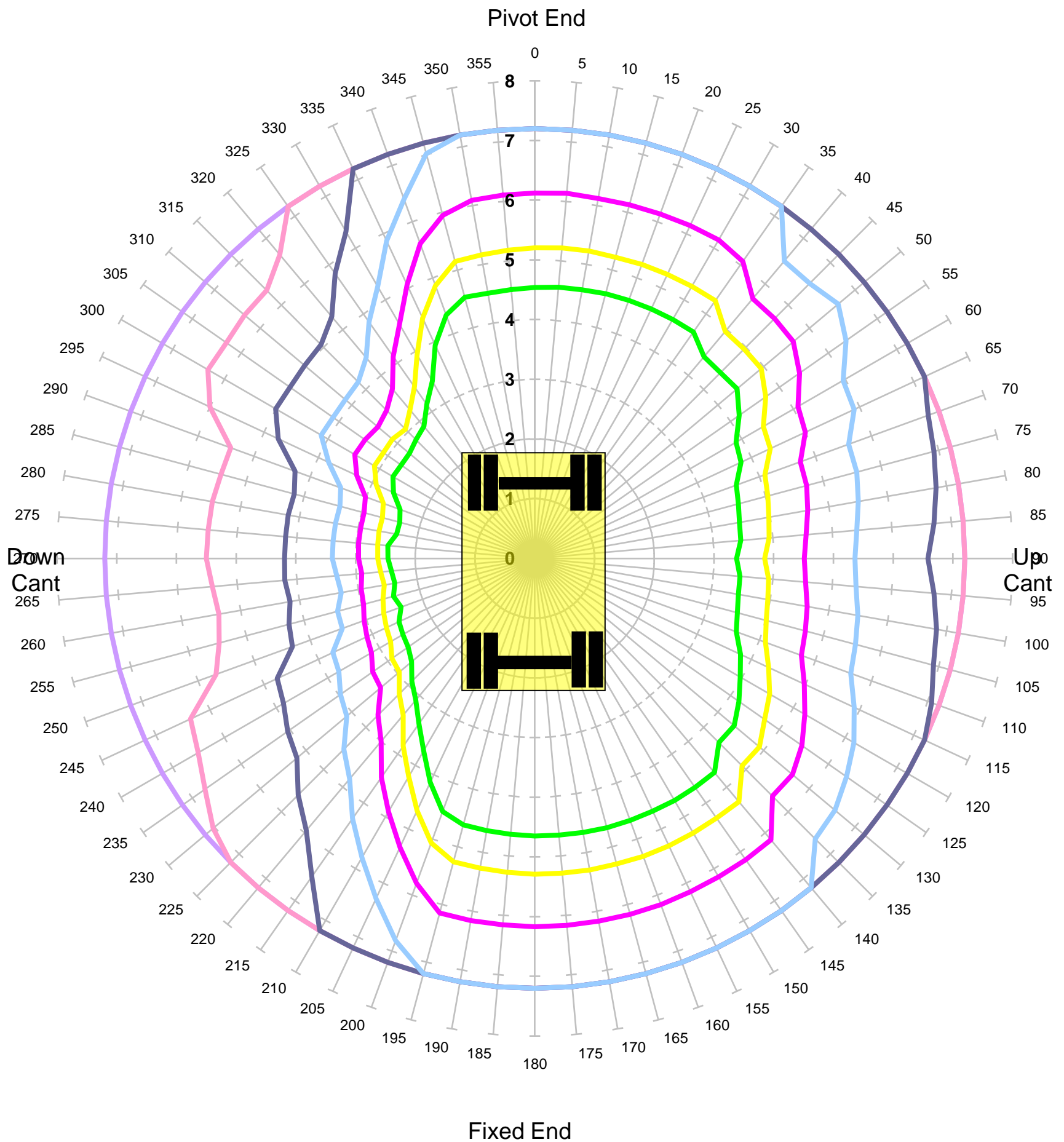

Units in Tonnes

- 1
- 2
- 3
- 4
- 5
- 6
- 7

MACHINE & MODEL:	Komatsu PW160-11	REFERENCE:	3.00m Jib
SERIAL No:	H65493	DATE OF CHART:	12-Sep-2022
EQUIPMENT:	2.00m + 3.47m + 2.50m	SAFETY FACTOR:	90.0%
COMMENT:			

Komatsu PW160-11
Max Capacity Contours of Radius(m) Plots 2.5m Dipper
Level Ground Height 2m Lift ALP1
Unlocked Road

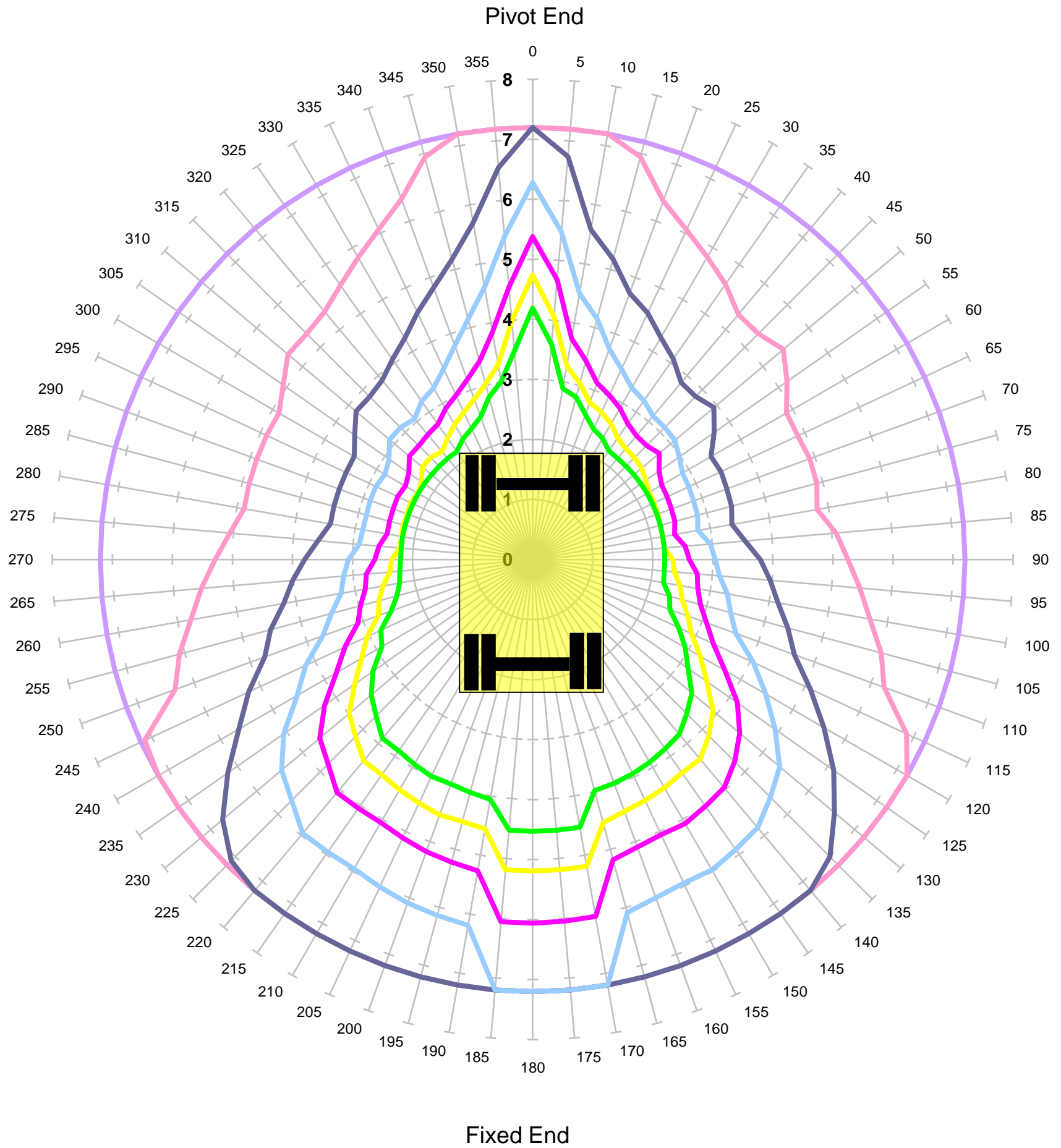

Units in Tonnes

- 1
- 2
- 3
- 4
- 5
- 6
- 7

MACHINE & MODEL:	Komatsu PW160-11	REFERENCE:	3.00m Jib
SERIAL No:	H65493	DATE OF CHART:	12-Sep-2022
EQUIPMENT:	2.00m + 3.47m + 2.50m	SAFETY FACTOR:	71.0%
COMMENT:			

Komatsu PW160-11
Max Capacity Contours of Radius(m) Plots 2.5m Dipper
Level Ground Height 2m Lift ALP1
Locked Road

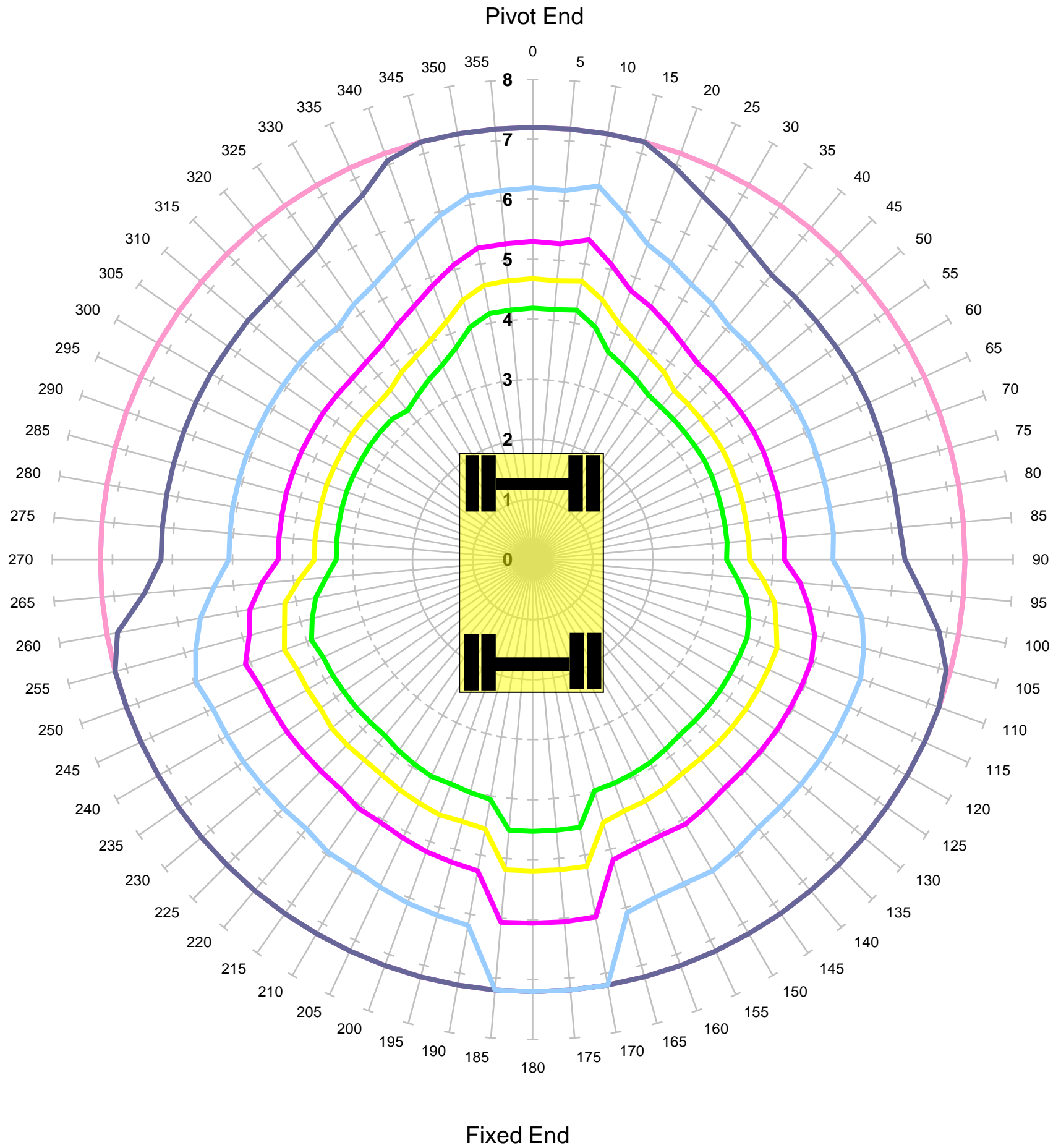

Units in Tonnes

- 1
- 2
- 3
- 4
- 5
- 6
- 7

MACHINE & MODEL:	Komatsu PW160-11	REFERENCE:	3.00m Jib
SERIAL No:	H65493	DATE OF CHART:	12-Sep-2022
EQUIPMENT:	2.00m + 3.47m + 2.50m	SAFETY FACTOR:	71.0%
COMMENT:			

Komatsu PW160-11

**Max Capacity Contours of Radius(m) Plots 2.5m Dipper
Gradient 1 in -25 Height 2m Lift ALP1
Unlocked Rail Cant -150mm - Tandem Lift**

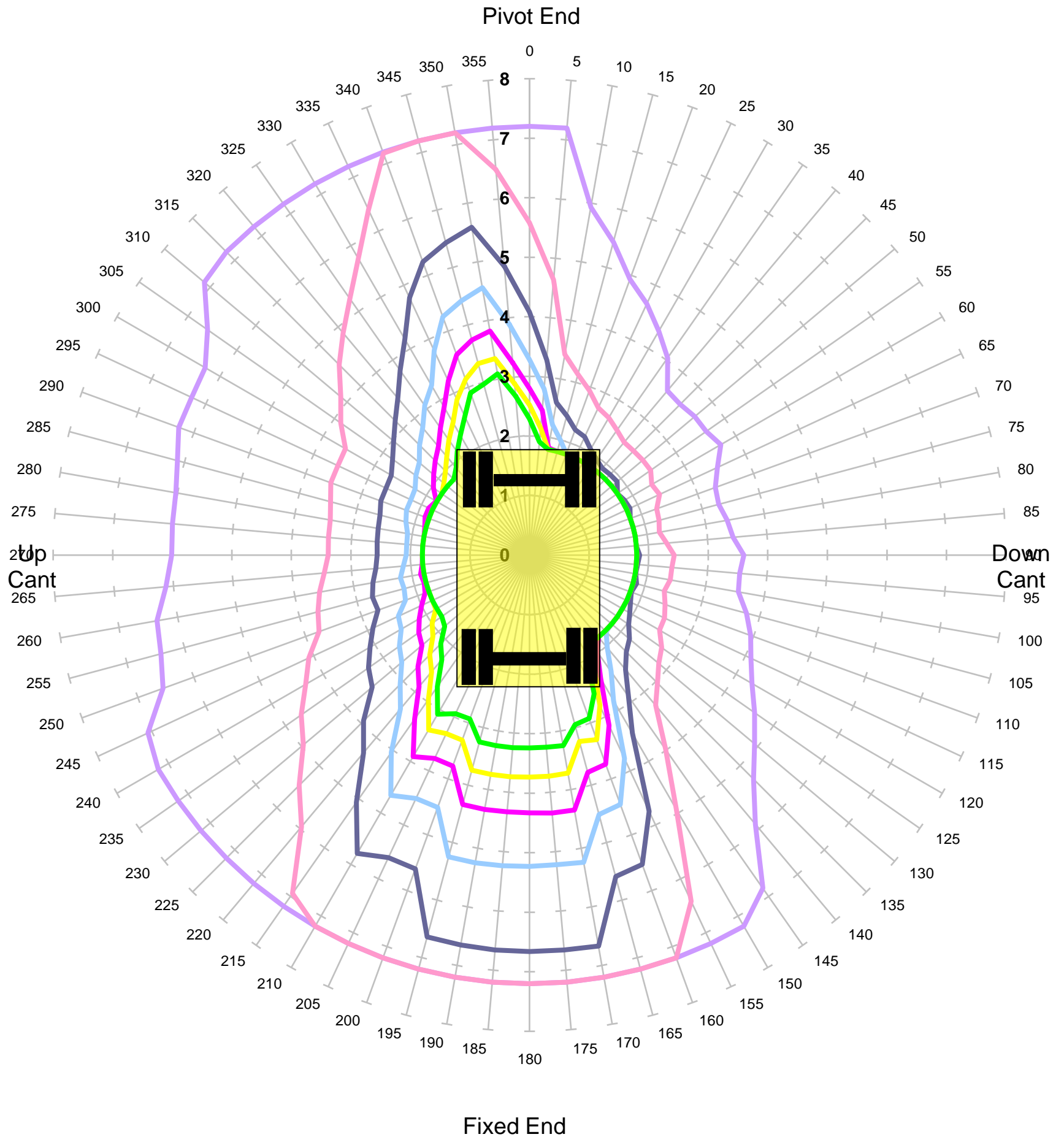

Units in Tonnes

- 1
- 2
- 3
- 4
- 5
- 6
- 7

MACHINE & MODEL:	Komatsu PW160-11	REFERENCE:	3.00m Jib
SERIAL No:	H65493	DATE OF CHART:	12-Sep-2022
EQUIPMENT:	2.00m + 3.47m + 2.50m	SAFETY FACTOR:	44.0%
COMMENT:			

Komatsu PW160-11

**Max Capacity Contours of Radius(m) Plots 2.5m Dipper
Gradient 1 in -25 Height 2m Lift ALP1
Unlocked Rail Cant -50mm - Tandem Lift**

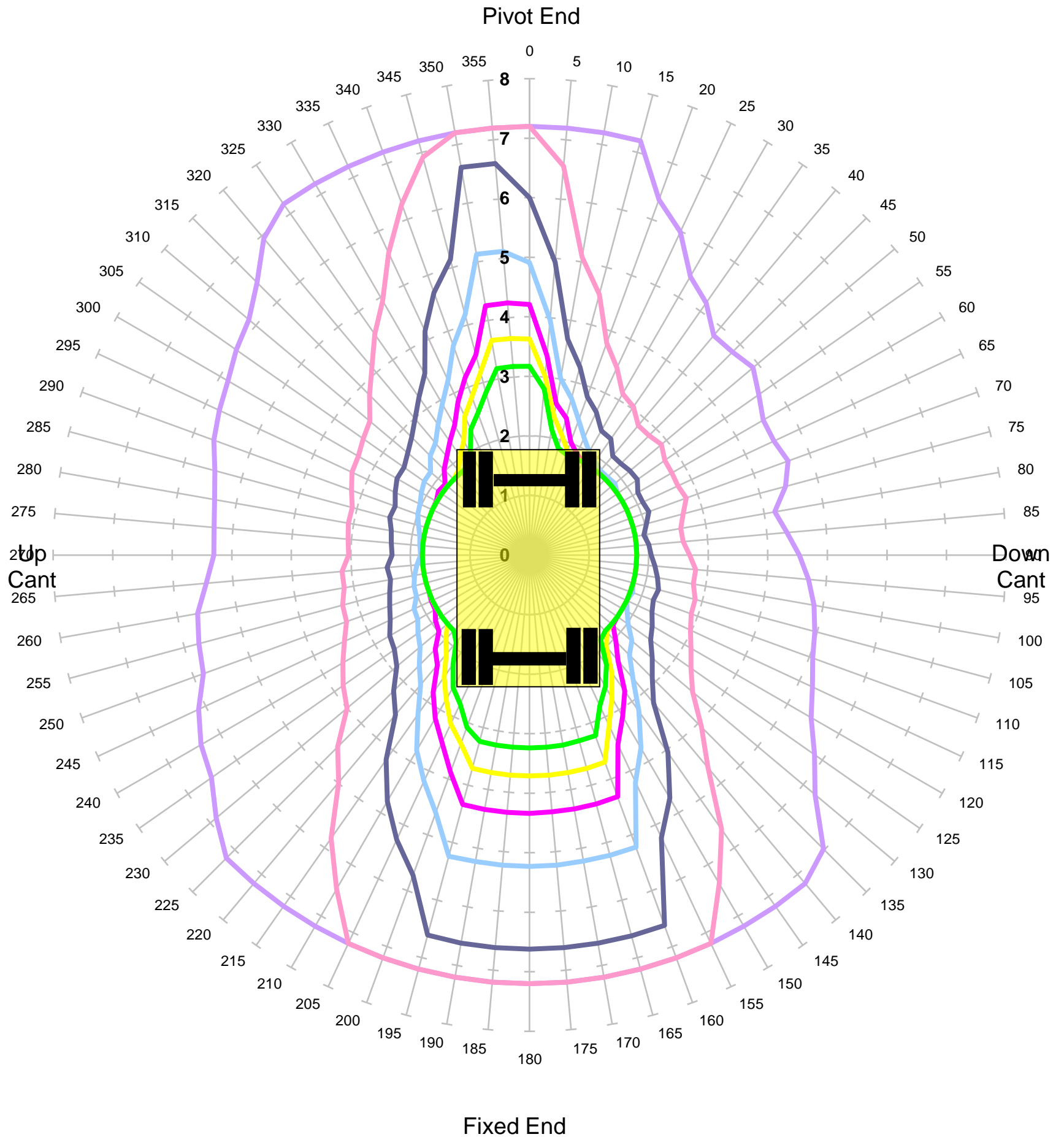

Units in Tonnes

- 1
- 2
- 3
- 4
- 5
- 6
- 7

MACHINE & MODEL:	Komatsu PW160-11	REFERENCE:	3.00m Jib
SERIAL No:	H65493	DATE OF CHART:	12-Sep-2022
EQUIPMENT:	2.00m + 3.47m + 2.50m	SAFETY FACTOR:	44.0%
COMMENT:			

Komatsu PW160-11

**Max Capacity Contours of Radius(m) Plots 2.5m Dipper
Gradient 1 in -25 Height 2m Lift ALP1
Unlocked Rail Cant 50mm - Tandem Lift**

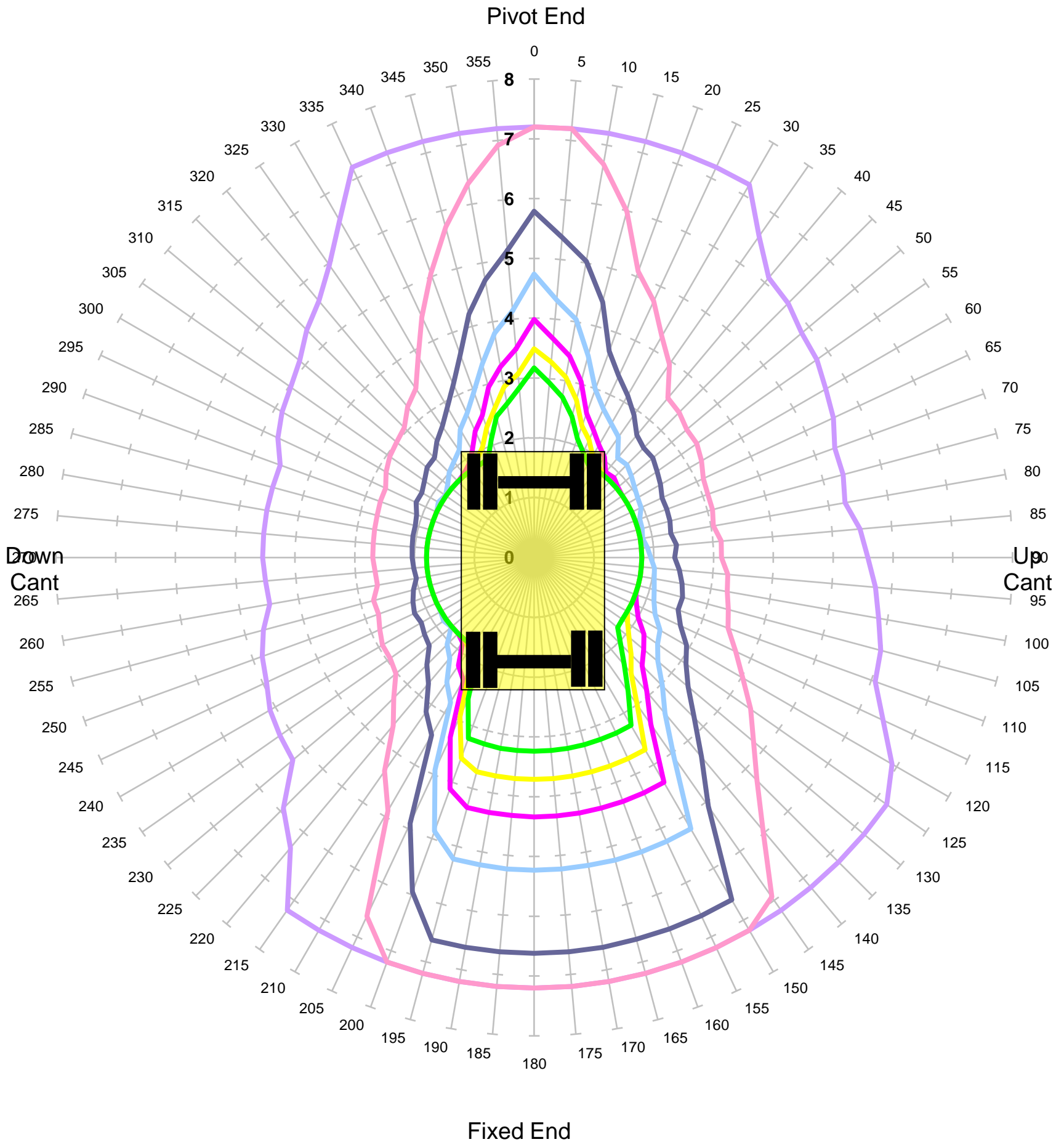

Units in Tonnes

- 1
- 2
- 3
- 4
- 5
- 6
- 7

MACHINE & MODEL:	Komatsu PW160-11	REFERENCE:	3.00m Jib
SERIAL No:	H65493	DATE OF CHART:	12-Sep-2022
EQUIPMENT:	2.00m + 3.47m + 2.50m	SAFETY FACTOR:	44.0%
COMMENT:			

Komatsu PW160-11

**Max Capacity Contours of Radius(m) Plots 2.5m Dipper
Gradient 1 in -25 Height 2m Lift ALP1
Unlocked Rail Cant 150mm - Tandem Lift**

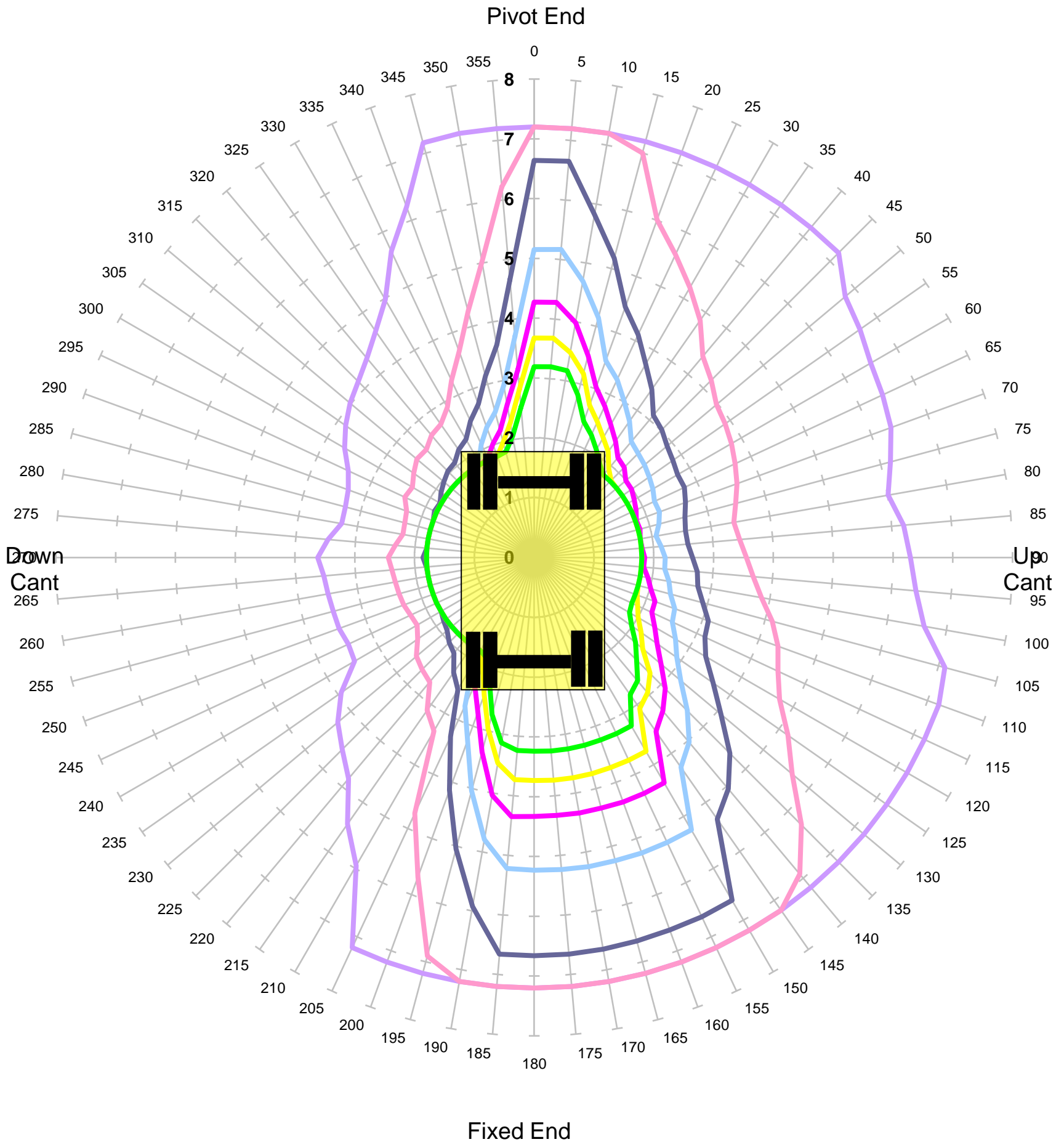

Units in Tonnes

- 1
- 2
- 3
- 4
- 5
- 6
- 7

MACHINE & MODEL:	Komatsu PW160-11	REFERENCE:	3.00m Jib
SERIAL No:	H65493	DATE OF CHART:	12-Sep-2022
EQUIPMENT:	2.00m + 3.47m + 2.50m	SAFETY FACTOR:	44.0%
COMMENT:			

Komatsu PW160-11

**Max Capacity Contours of Radius(m) Plots 2.5m Dipper
Gradient 1 in -25 Height 2m Lift ALP1
Locked Rail Cant -150mm - Tandem Lift**

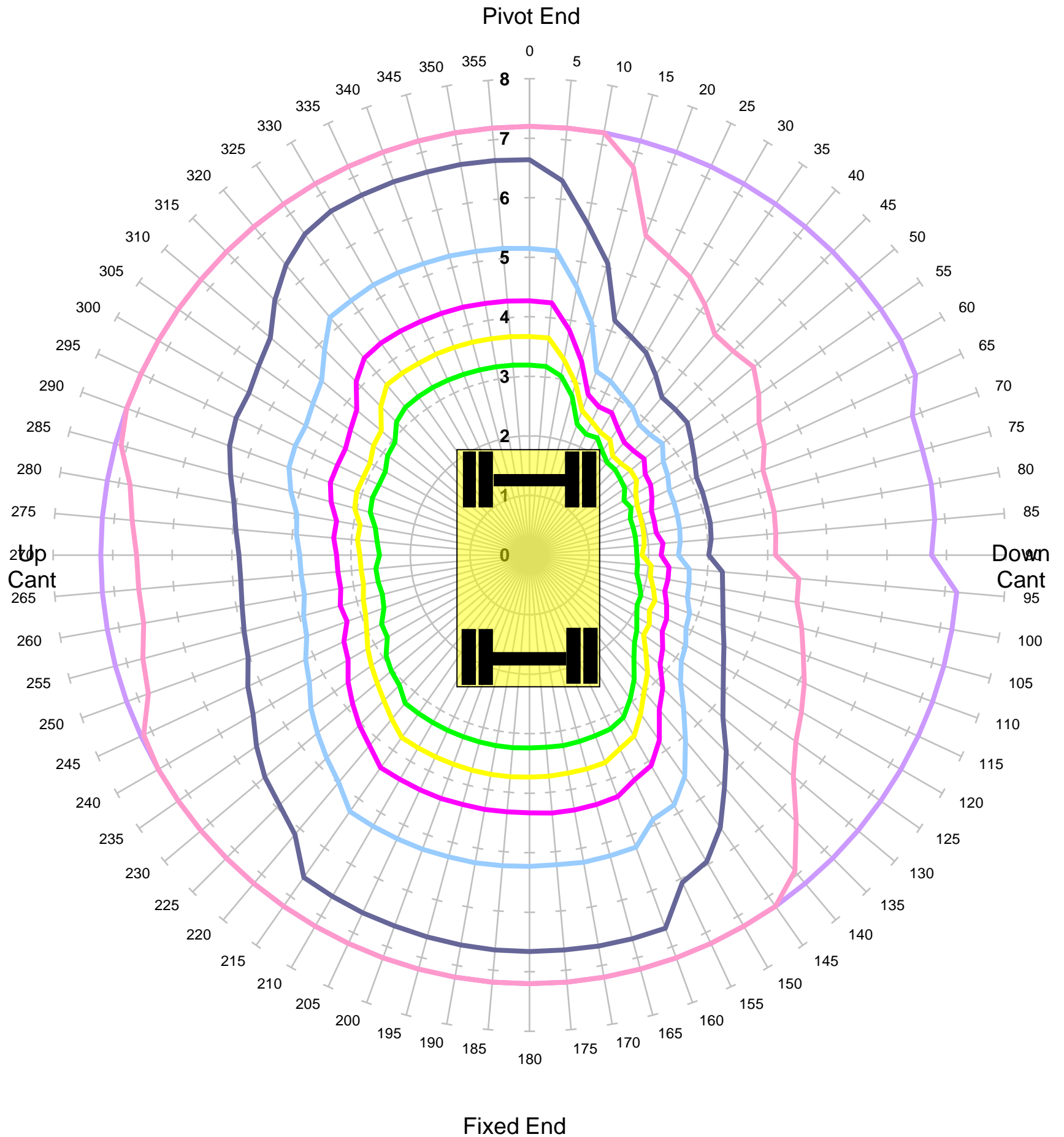

Units in Tonnes

- 1
- 2
- 3
- 4
- 5
- 6
- 7

MACHINE & MODEL:	Komatsu PW160-11	REFERENCE:	3.00m Jib
SERIAL No:	H65493	DATE OF CHART:	12-Sep-2022
EQUIPMENT:	2.00m + 3.47m + 2.50m	SAFETY FACTOR:	59.0%
COMMENT:			

Komatsu PW160-11

**Max Capacity Contours of Radius(m) Plots 2.5m Dipper
Gradient 1 in -25 Height 2m Lift ALP1
Locked Rail Cant -50mm - Tandem Lift**

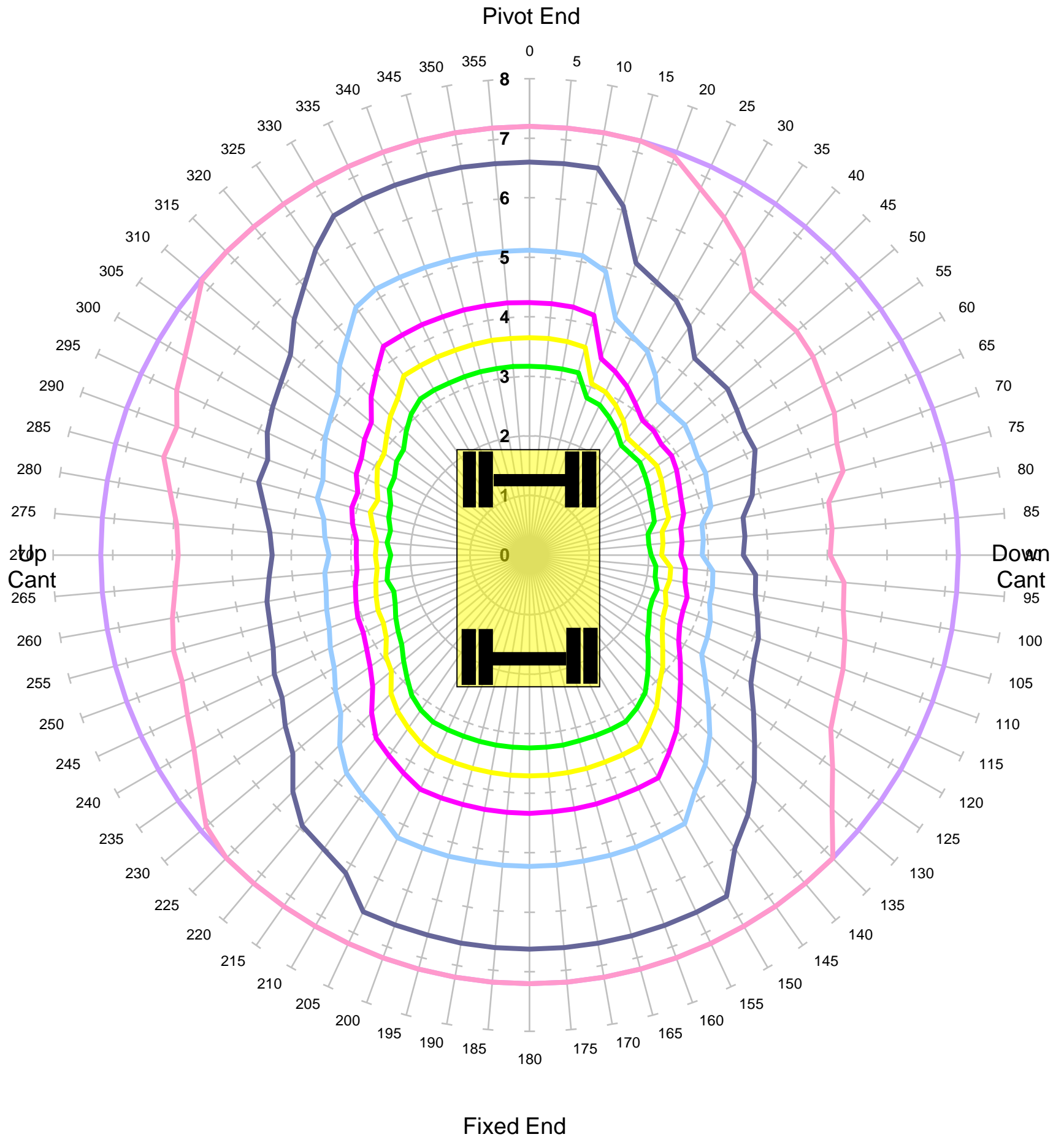

Units in Tonnes

- 1
- 2
- 3
- 4
- 5
- 6
- 7

MACHINE & MODEL:	Komatsu PW160-11	REFERENCE:	3.00m Jib
SERIAL No:	H65493	DATE OF CHART:	12-Sep-2022
EQUIPMENT:	2.00m + 3.47m + 2.50m	SAFETY FACTOR:	59.0%
COMMENT:			

Komatsu PW160-11

**Max Capacity Contours of Radius(m) Plots 2.5m Dipper
Gradient 1 in -25 Height 2m Lift ALP1
Locked Rail Cant 50mm - Tandem Lift**

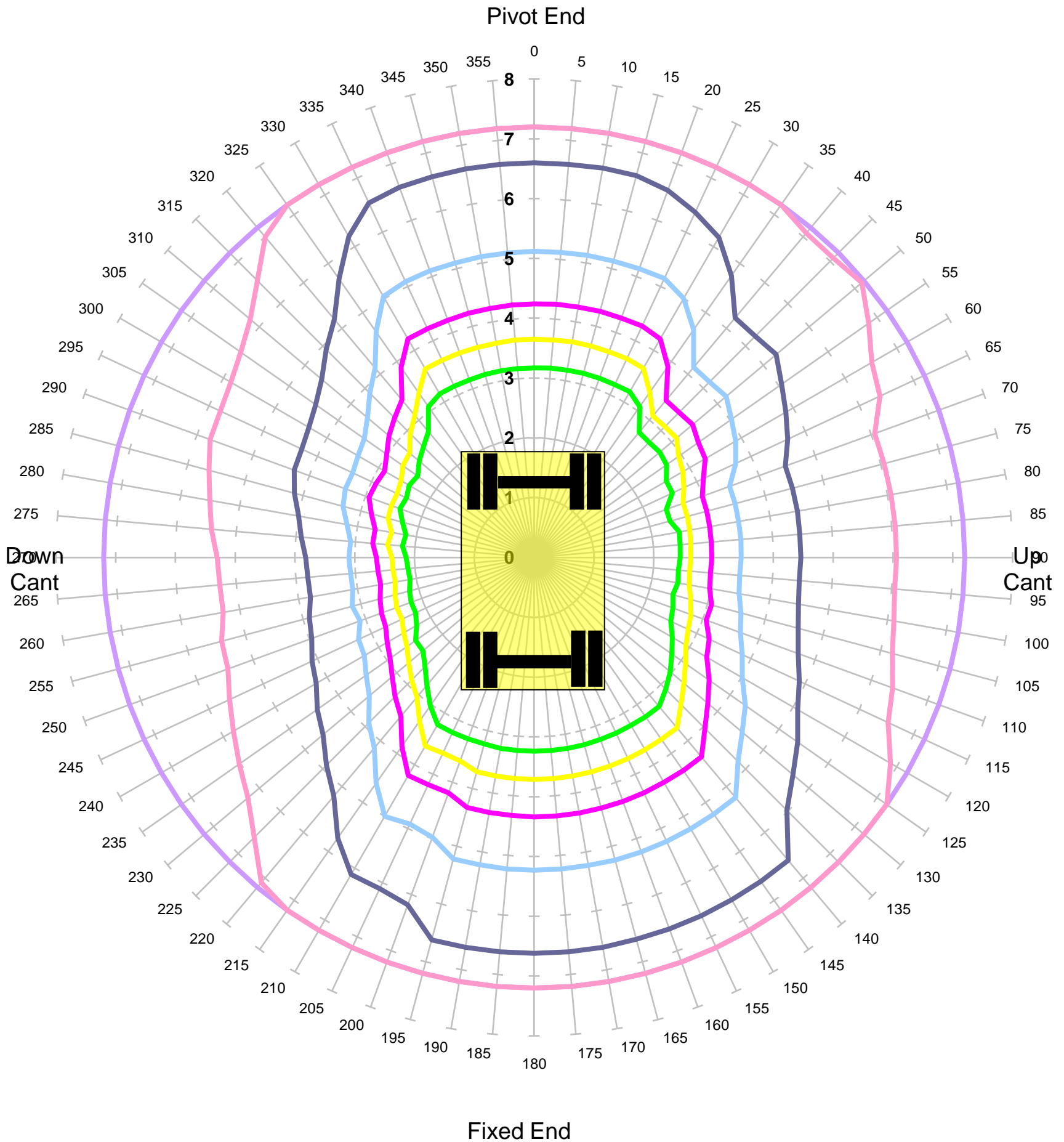

Units in Tonnes

- 1
- 2
- 3
- 4
- 5
- 6
- 7

MACHINE & MODEL:	Komatsu PW160-11	REFERENCE:	3.00m Jib
SERIAL No:	H65493	DATE OF CHART:	12-Sep-2022
EQUIPMENT:	2.00m + 3.47m + 2.50m	SAFETY FACTOR:	59.0%
COMMENT:			

Komatsu PW160-11

**Max Capacity Contours of Radius(m) Plots 2.5m Dipper
Gradient 1 in -25 Height 2m Lift ALP1
Locked Rail Cant 150mm - Tandem Lift**

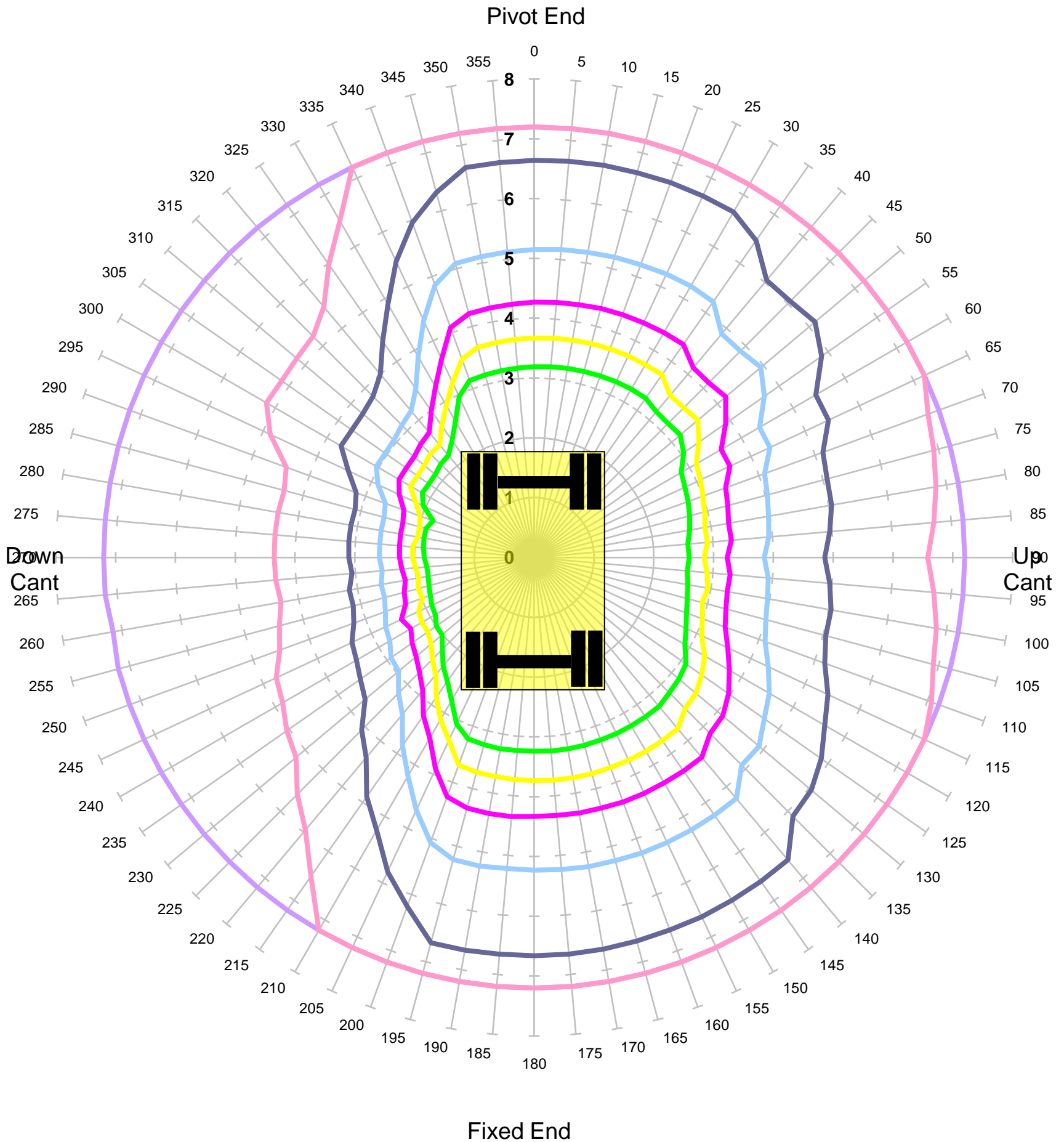

MACHINE & MODEL:	Komatsu PW160-11	REFERENCE:	3.00m Jib
SERIAL No:	H65493	DATE OF CHART:	12-Sep-2022
EQUIPMENT:	2.00m + 3.47m + 2.50m	SAFETY FACTOR:	59.0%
COMMENT:			

Komatsu PW160-11
Max Capacity Contours of Radius(m) Plots 2.5m Dipper
Level Ground Height 2m Lift ALP1
Unlocked Road - Tandem Lift

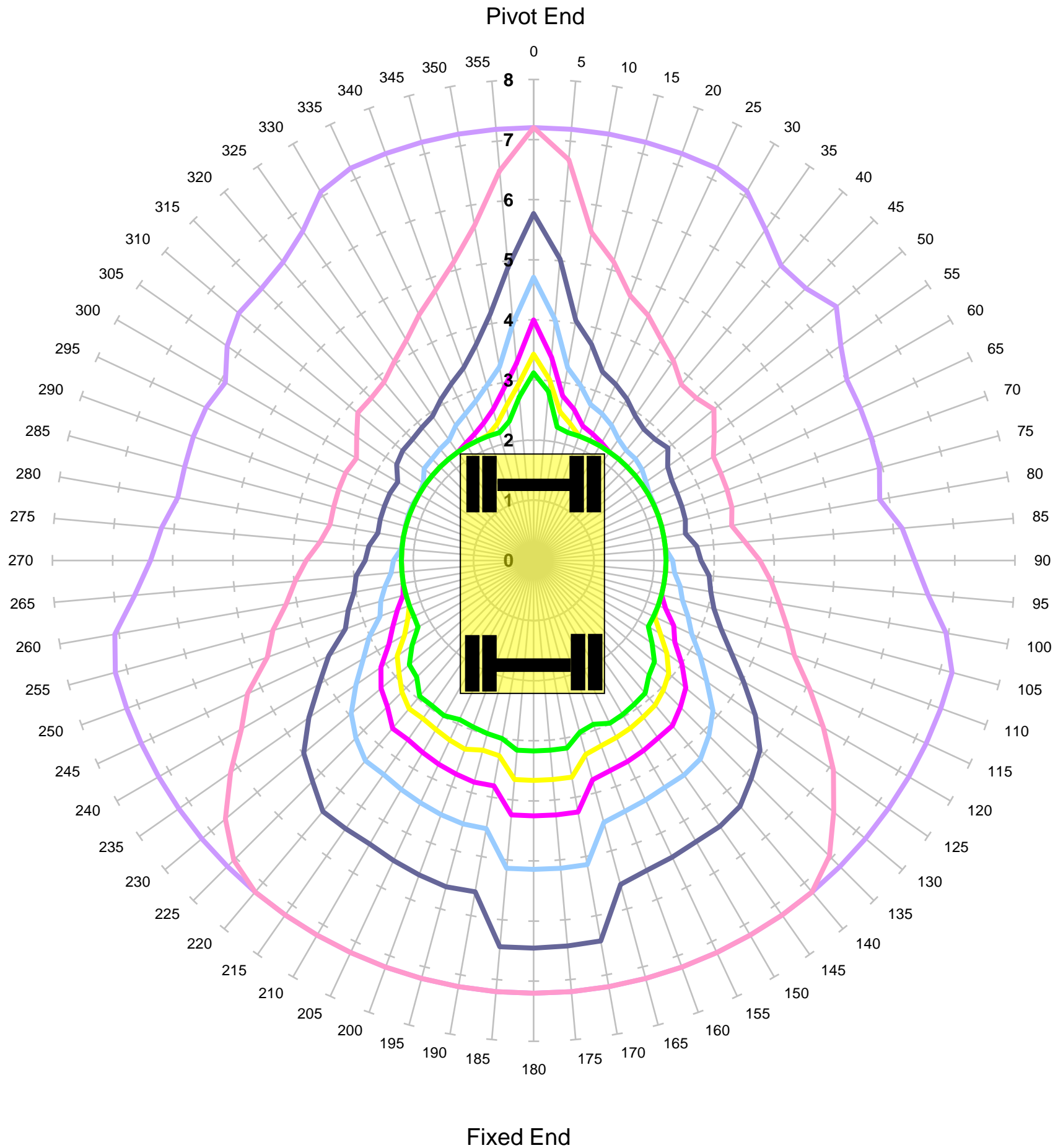

Units in Tonnes

- 1
- 2
- 3
- 4
- 5
- 6
- 7

MACHINE & MODEL:	Komatsu PW160-11	REFERENCE:	3.00m Jib
SERIAL No:	H65493	DATE OF CHART:	12-Sep-2022
EQUIPMENT:	2.00m + 3.47m + 2.50m	SAFETY FACTOR:	47.0%
COMMENT:			

Komatsu PW160-11
Max Capacity Contours of Radius(m) Plots 2.5m Dipper
Level Ground Height 2m Lift ALP1
Locked Road - Tandem Lift

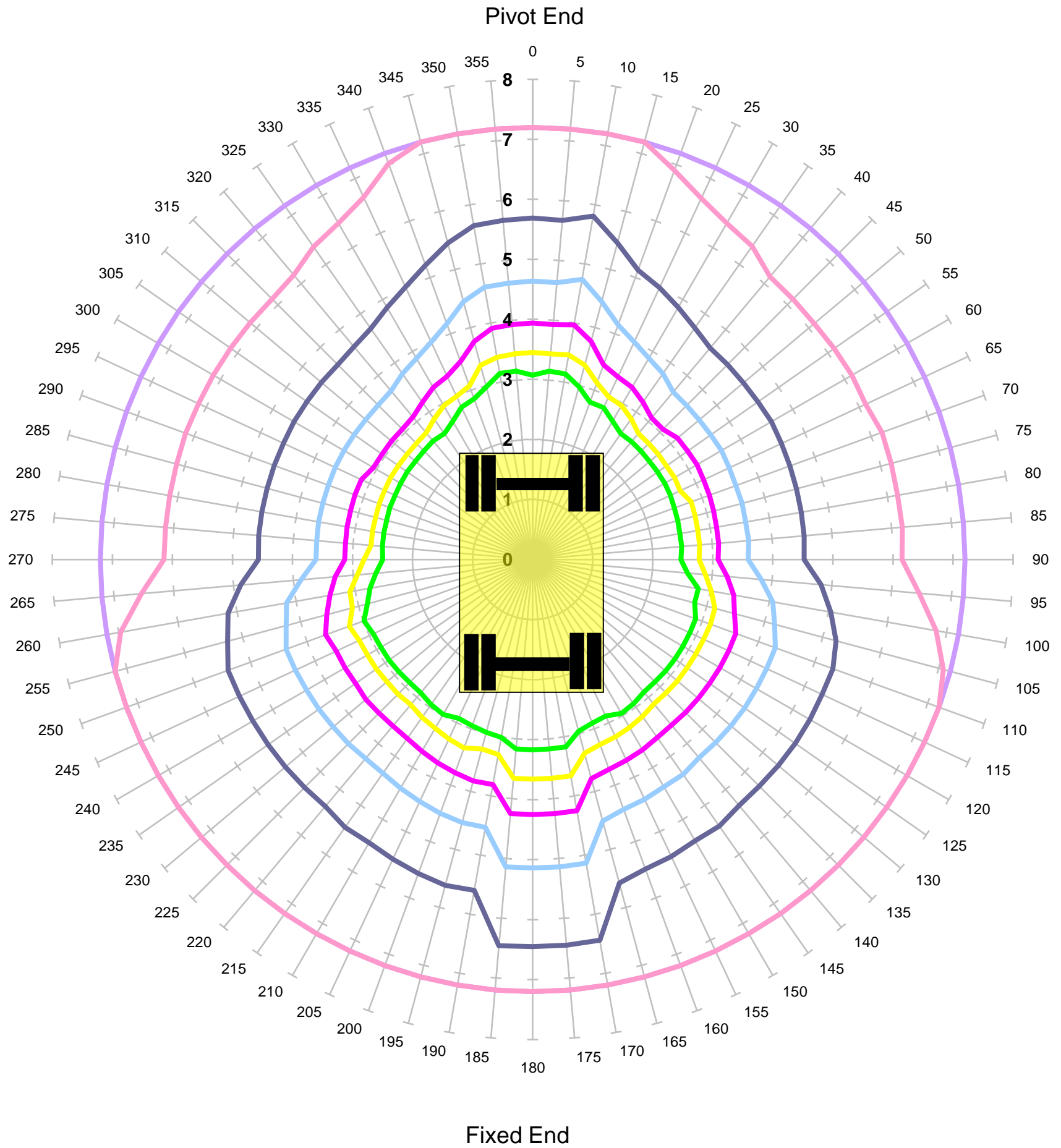

Units in Tonnes

- 1
- 2
- 3
- 4
- 5
- 6
- 7

MACHINE & MODEL:	Komatsu PW160-11	REFERENCE:	3.00m Jib
SERIAL No:	H65493	DATE OF CHART:	12-Sep-2022
EQUIPMENT:	2.00m + 3.47m + 2.50m	SAFETY FACTOR:	47.0%
COMMENT:			

Komatsu PW160-11
Max Capacity Contours of Radius(m) Plots 2.5m Dipper
Gradient 1 in -25 Height 2m Lift QH
Unlocked Rail Cant -150mm

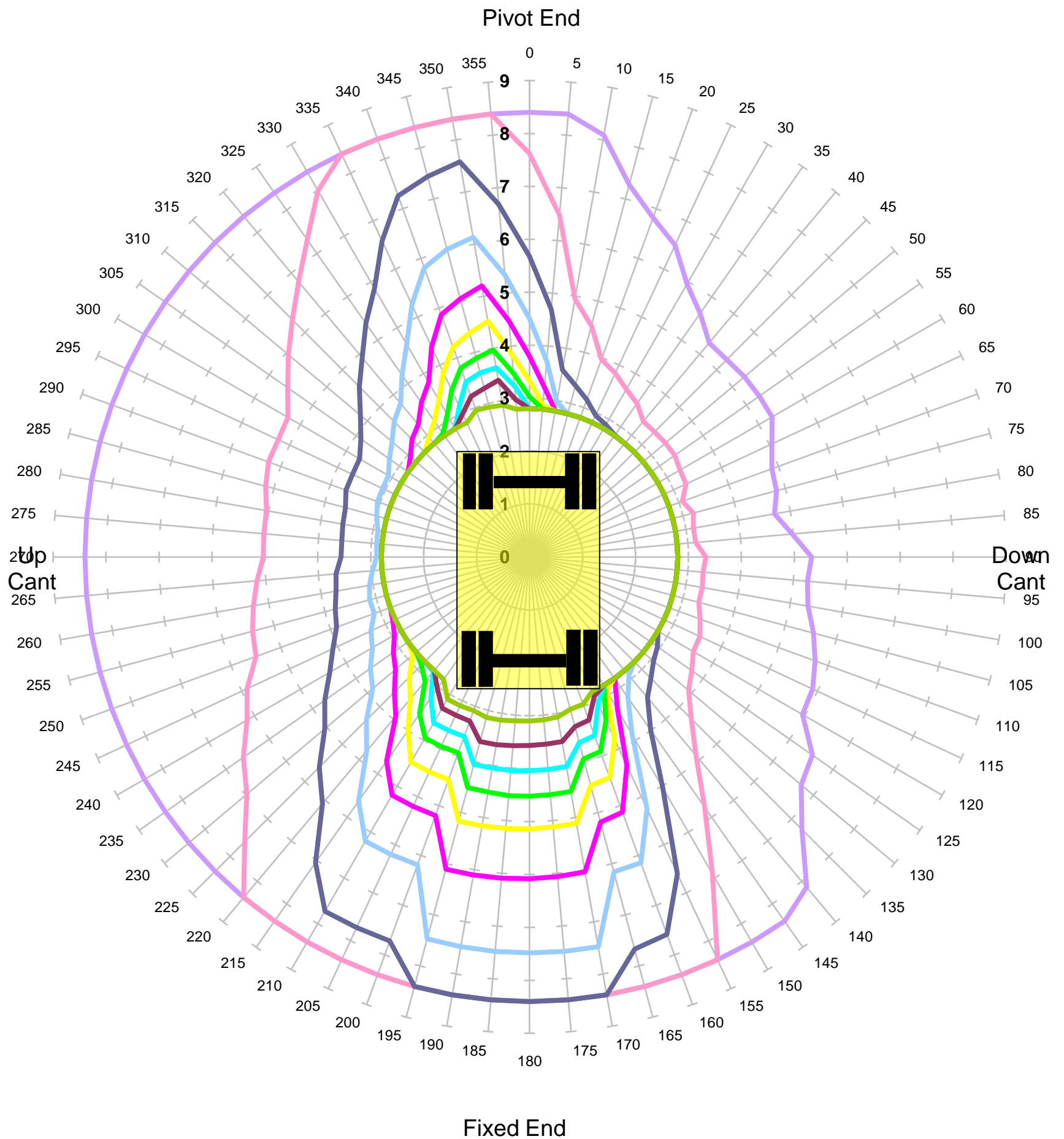

Units in Tonnes

- 1
- 2
- 3
- 4
- 5
- 6
- 7
- 8
- 9
- 10

MACHINE & MODEL:	Komatsu PW160-11	REFERENCE:	3.00m Jib
SERIAL No:	H65493	DATE OF CHART:	12-Sep-2022
EQUIPMENT:	2.00m + 3.47m + 2.50m	SAFETY FACTOR:	67.0%
COMMENT:			

Komatsu PW160-11
Max Capacity Contours of Radius(m) Plots 2.5m Dipper
Gradient 1 in -25 Height 2m Lift QH
Unlocked Rail Cant -50mm

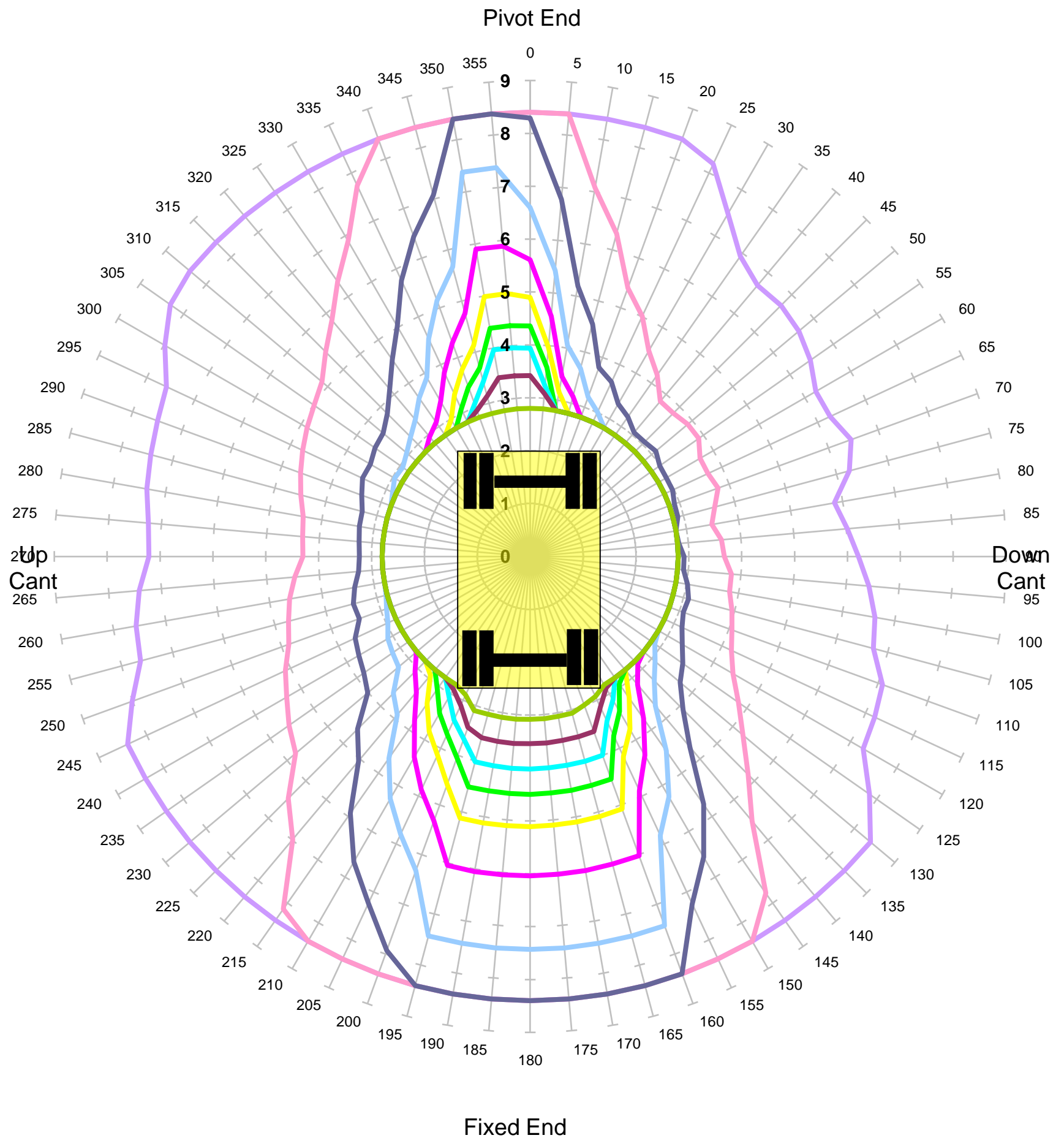

Units in Tonnes

- 1
- 2
- 3
- 4
- 5
- 6
- 7
- 8
- 9
- 10

MACHINE & MODEL:	Komatsu PW160-11	REFERENCE:	3.00m Jib
SERIAL No:	H65493	DATE OF CHART:	12-Sep-2022
EQUIPMENT:	2.00m + 3.47m + 2.50m	SAFETY FACTOR:	67.0%
COMMENT:			

Komatsu PW160-11
Max Capacity Contours of Radius(m) Plots 2.5m Dipper
Gradient 1 in -25 Height 2m Lift QH
Unlocked Rail Cant 50mm

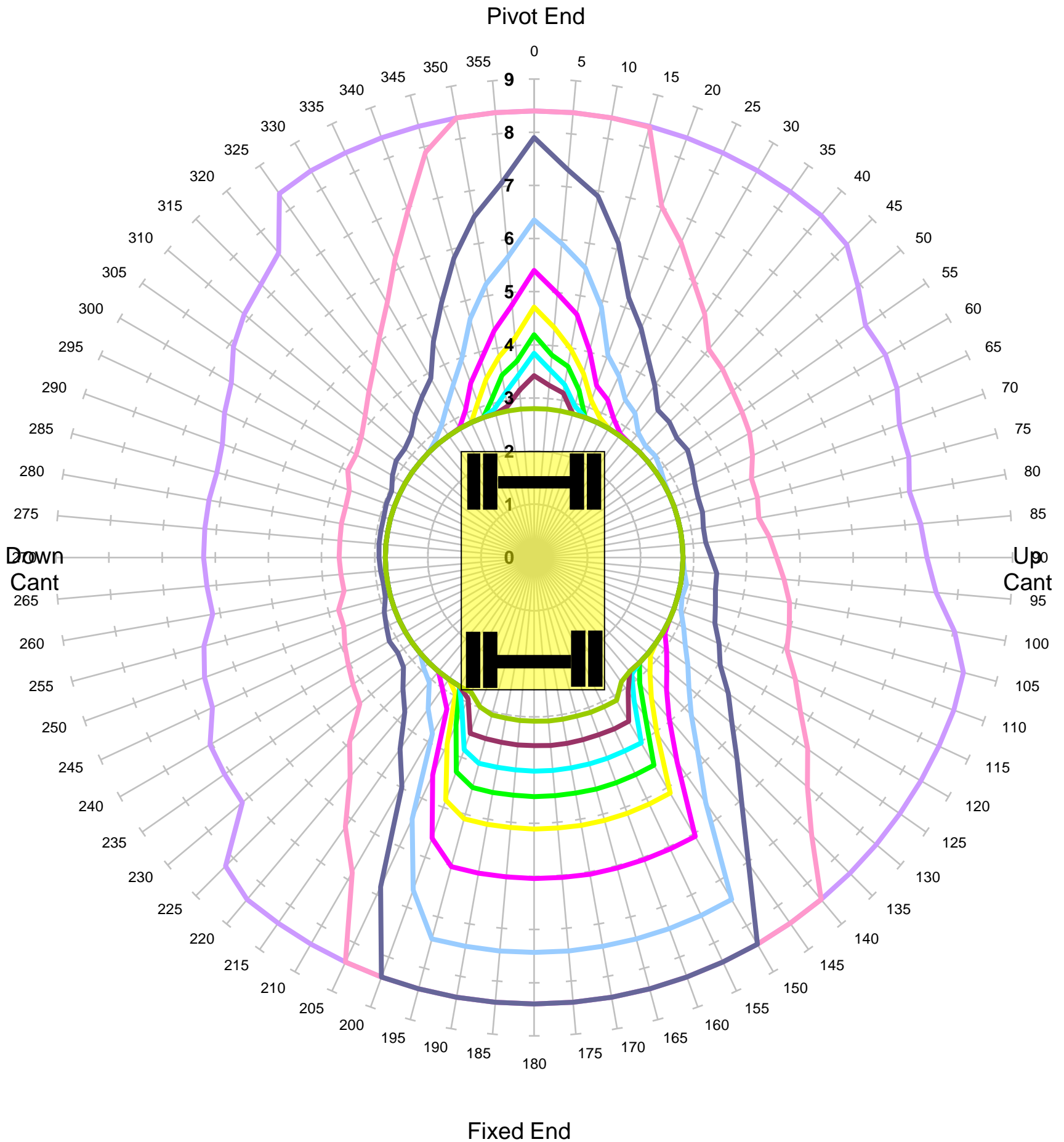

Units in Tonnes

- 1
- 2
- 3
- 4
- 5
- 6
- 7
- 8
- 9
- 10

MACHINE & MODEL:	Komatsu PW160-11	REFERENCE:	3.00m Jib
SERIAL No:	H65493	DATE OF CHART:	12-Sep-2022
EQUIPMENT:	2.00m + 3.47m + 2.50m	SAFETY FACTOR:	67.0%
COMMENT:			

Komatsu PW160-11
Max Capacity Contours of Radius(m) Plots 2.5m Dipper
Gradient 1 in -25 Height 2m Lift QH
Unlocked Rail Cant 150mm

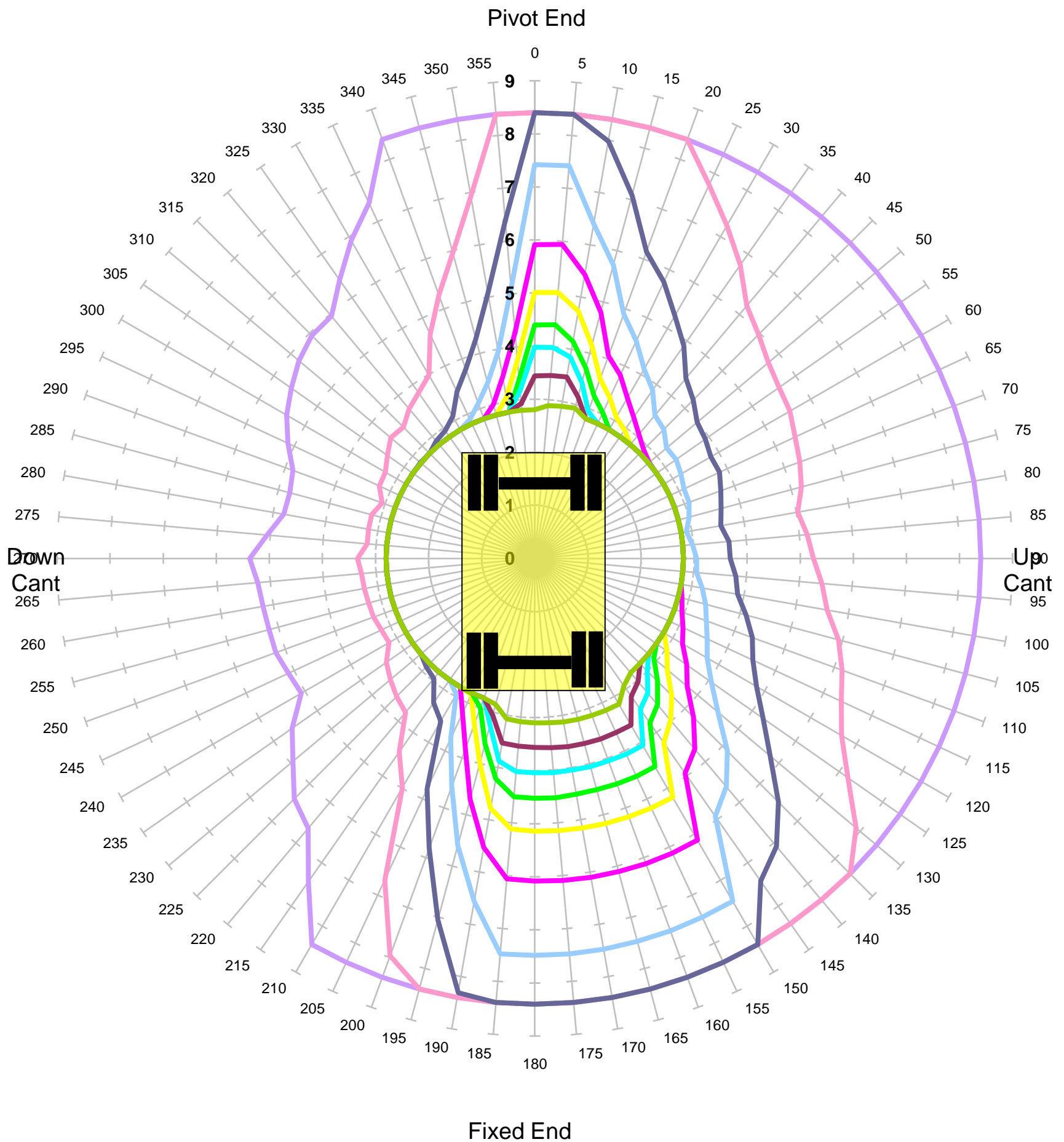

Units in Tonnes

- 1
- 2
- 3
- 4
- 5
- 6
- 7
- 8
- 9
- 10

MACHINE & MODEL:	Komatsu PW160-11	REFERENCE:	3.00m Jib
SERIAL No:	H65493	DATE OF CHART:	12-Sep-2022
EQUIPMENT:	2.00m + 3.47m + 2.50m	SAFETY FACTOR:	67.0%
COMMENT:			

Komatsu PW160-11
Max Capacity Contours of Radius(m) Plots 2.5m Dipper
Gradient 1 in -25 Height 2m Lift QH
Locked Rail Cant -150mm

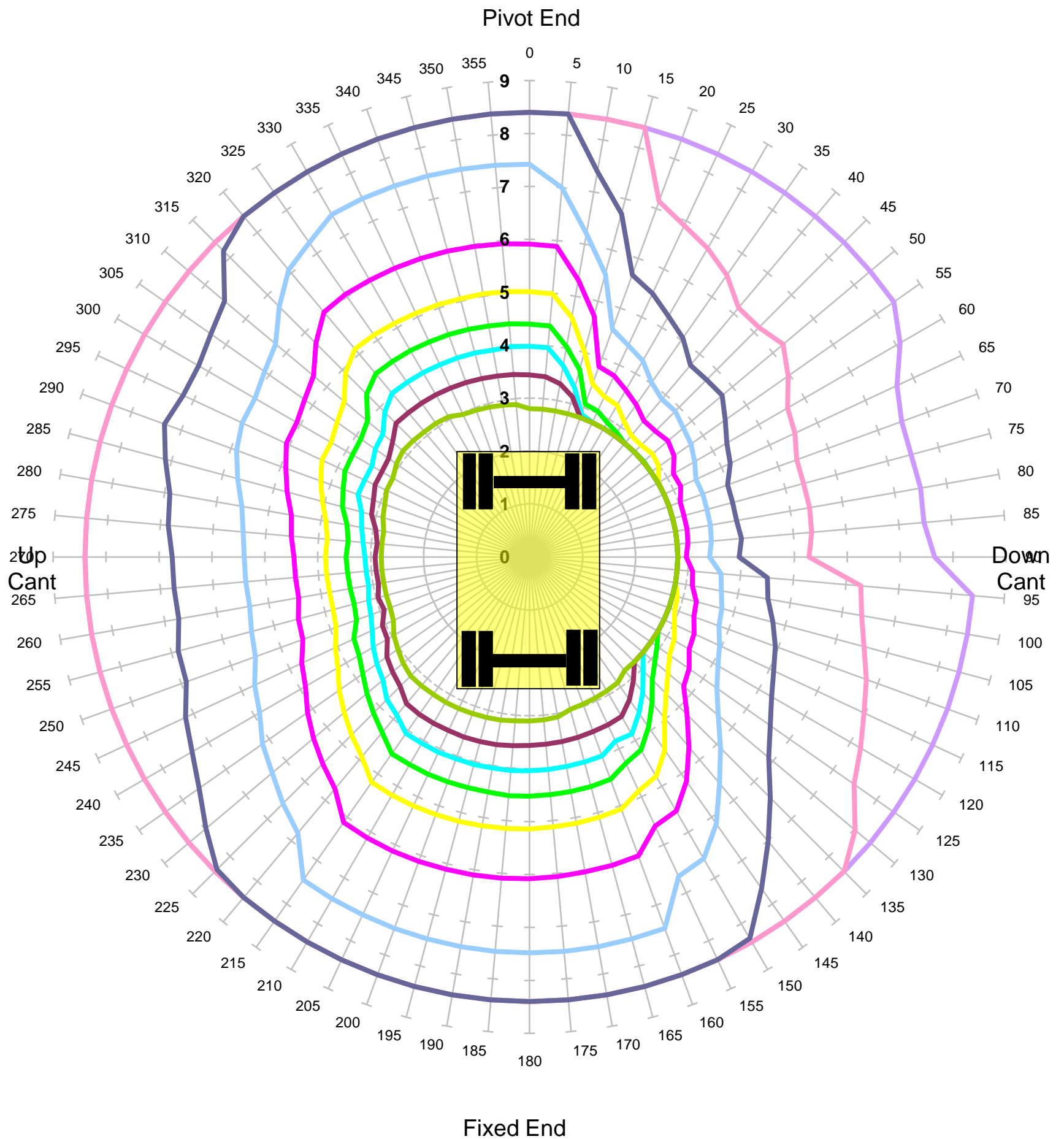

Units in Tonnes

- 1
- 2
- 3
- 4
- 5
- 6
- 7
- 8
- 9
- 10

MACHINE & MODEL:	Komatsu PW160-11	REFERENCE:	3.00m Jib
SERIAL No:	H65493	DATE OF CHART:	12-Sep-2022
EQUIPMENT:	2.00m + 3.47m + 2.50m	SAFETY FACTOR:	90.0%
COMMENT:			

Komatsu PW160-11

**Max Capacity Contours of Radius(m) Plots 2.5m Dipper
Gradient 1 in -25 Height 2m Lift QH
Locked Rail Cant -50mm**

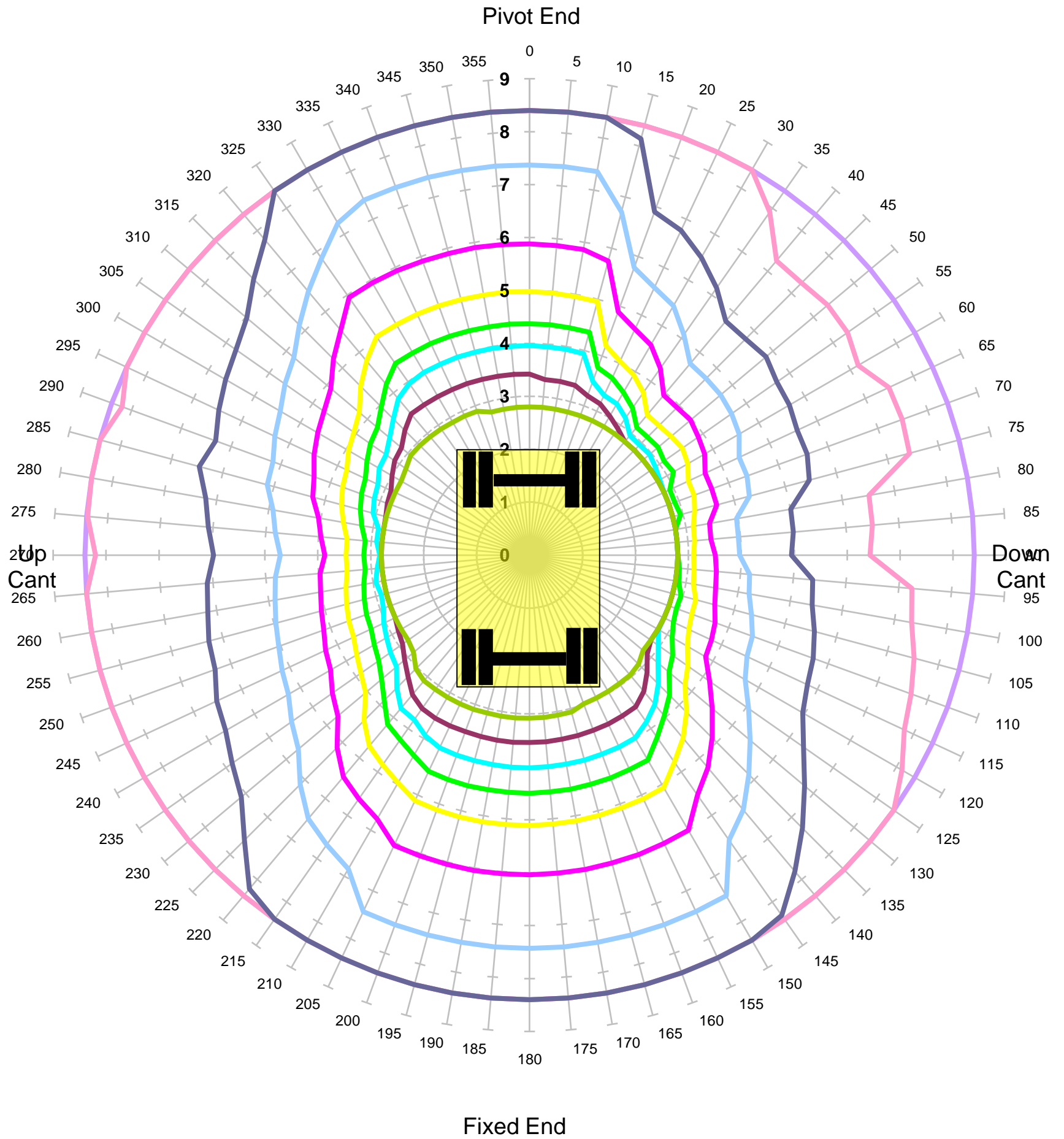

Units in Tonnes

- 1
- 2
- 3
- 4
- 5
- 6
- 7
- 8
- 9
- 10

MACHINE & MODEL:	Komatsu PW160-11	REFERENCE:	3.00m Jib
SERIAL No:	H65493	DATE OF CHART:	12-Sep-2022
EQUIPMENT:	2.00m + 3.47m + 2.50m	SAFETY FACTOR:	90.0%
COMMENT:			

Komatsu PW160-11
Max Capacity Contours of Radius(m) Plots 2.5m Dipper
Gradient 1 in -25 Height 2m Lift QH
Locked Rail Cant 50mm

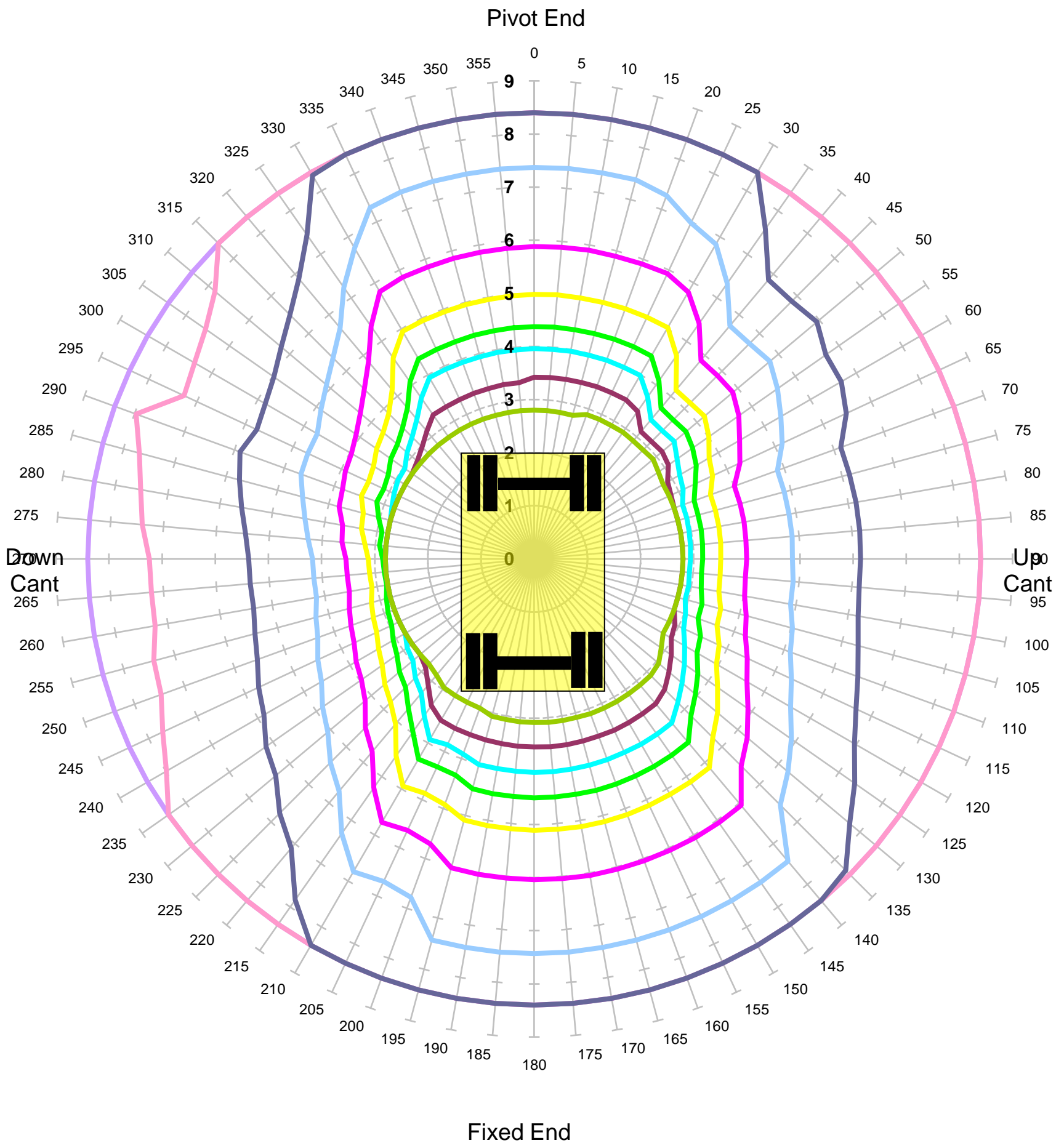

Units in Tonnes

- 1
- 2
- 3
- 4
- 5
- 6
- 7
- 8
- 9
- 10

MACHINE & MODEL:	Komatsu PW160-11	REFERENCE:	3.00m Jib
SERIAL No:	H65493	DATE OF CHART:	12-Sep-2022
EQUIPMENT:	2.00m + 3.47m + 2.50m	SAFETY FACTOR:	90.0%
COMMENT:			

Komatsu PW160-11
Max Capacity Contours of Radius(m) Plots 2.5m Dipper
Gradient 1 in -25 Height 2m Lift QH
Locked Rail Cant 150mm

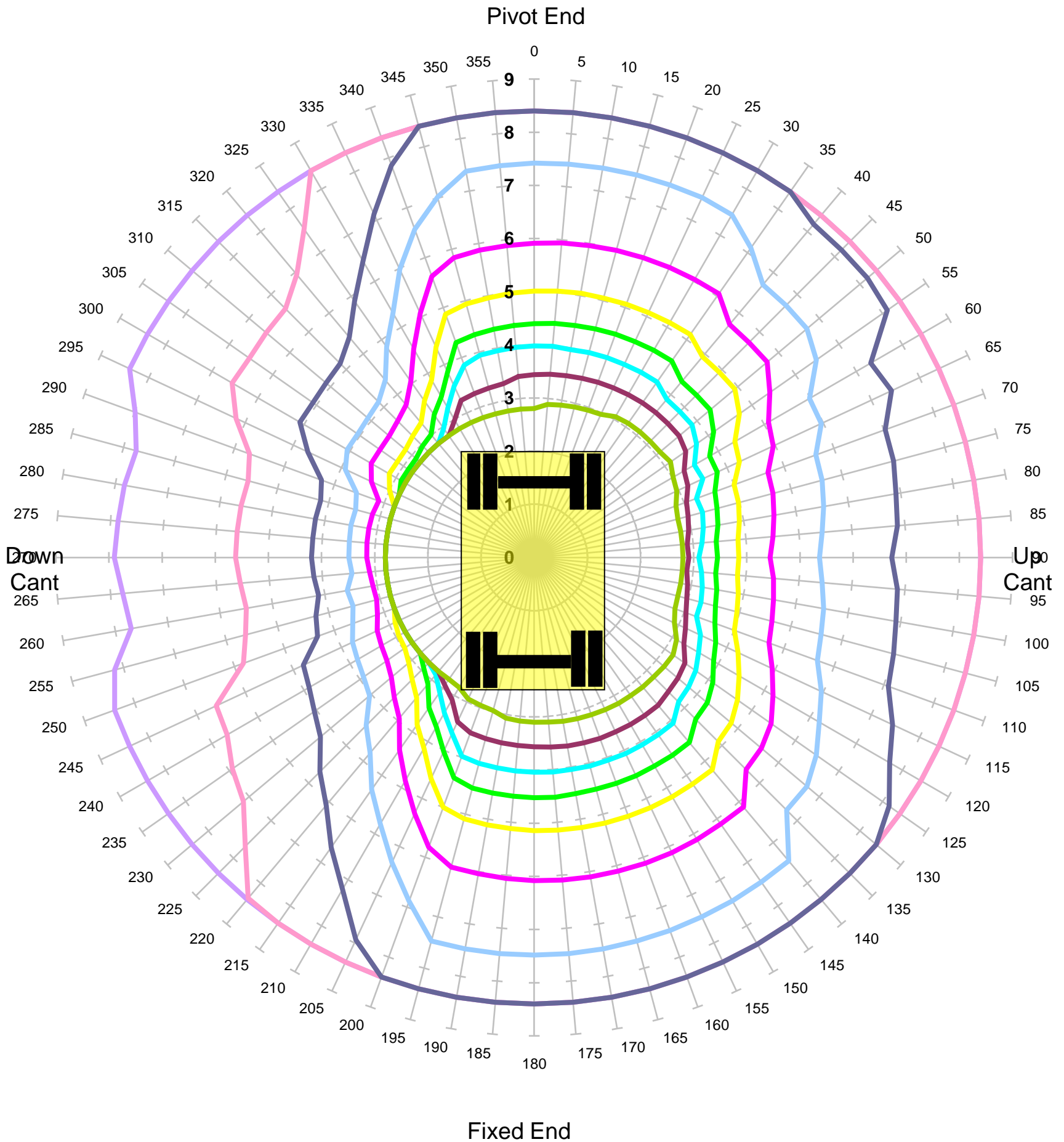

Units in Tonnes

- 1
- 2
- 3
- 4
- 5
- 6
- 7
- 8
- 9
- 10

MACHINE & MODEL:	Komatsu PW160-11	REFERENCE:	3.00m Jib
SERIAL No:	H65493	DATE OF CHART:	12-Sep-2022
EQUIPMENT:	2.00m + 3.47m + 2.50m	SAFETY FACTOR:	90.0%
COMMENT:			

Komatsu PW160-11
Max Capacity Contours of Radius(m) Plots 2.5m Dipper
Level Ground Height 2m Lift QH
Unlocked Road

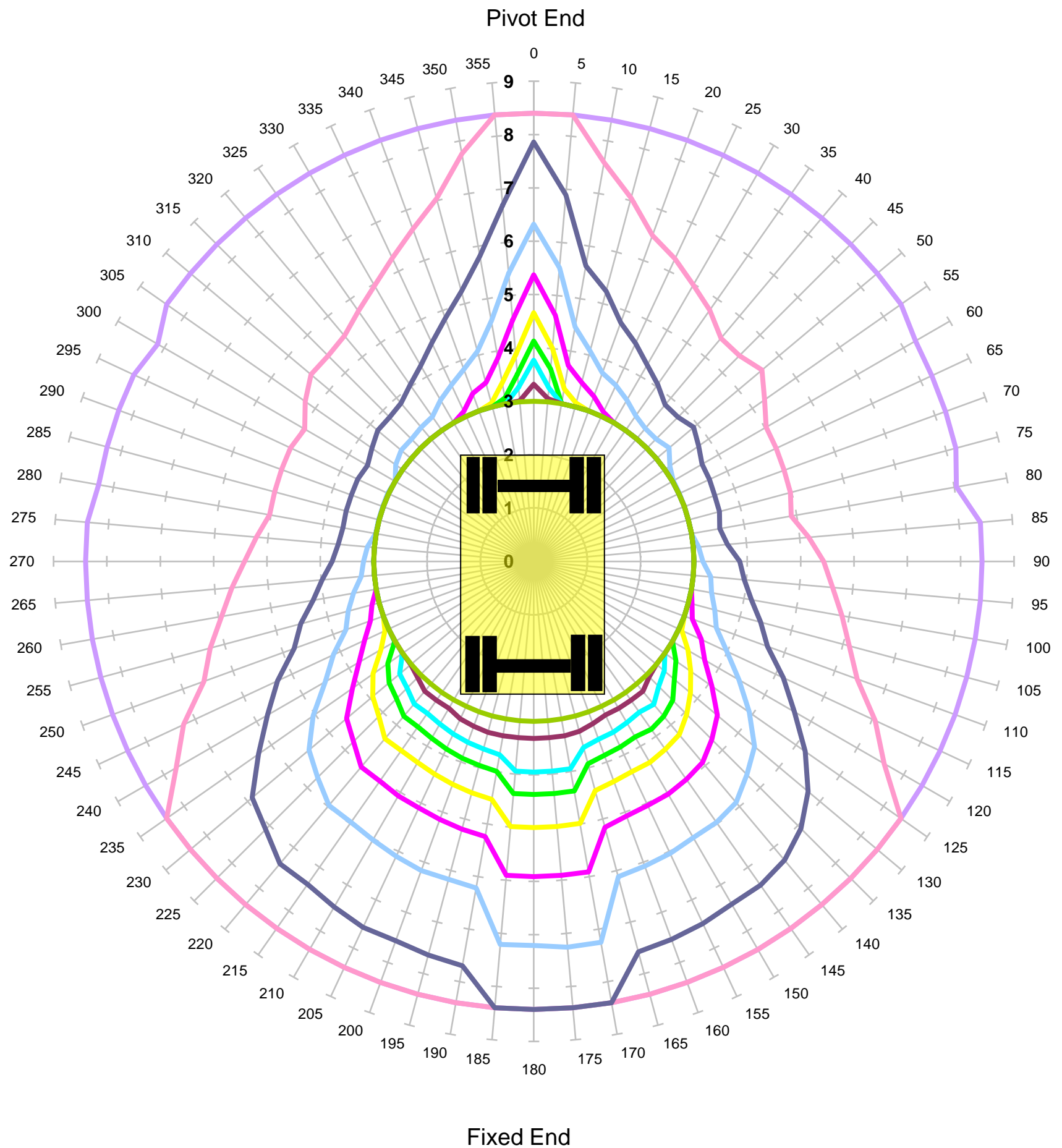

Units in Tonnes

- 1
- 2
- 3
- 4
- 5
- 6
- 7
- 8
- 9
- 10

MACHINE & MODEL:	Komatsu PW160-11	REFERENCE:	3.00m Jib
SERIAL No:	H65493	DATE OF CHART:	12-Sep-2022
EQUIPMENT:	2.00m + 3.47m + 2.50m	SAFETY FACTOR:	71.0%
COMMENT:			

Komatsu PW160-11

**Max Capacity Contours of Radius(m) Plots 2.5m Dipper
Level Ground Height 2m Lift QH
Locked Road**

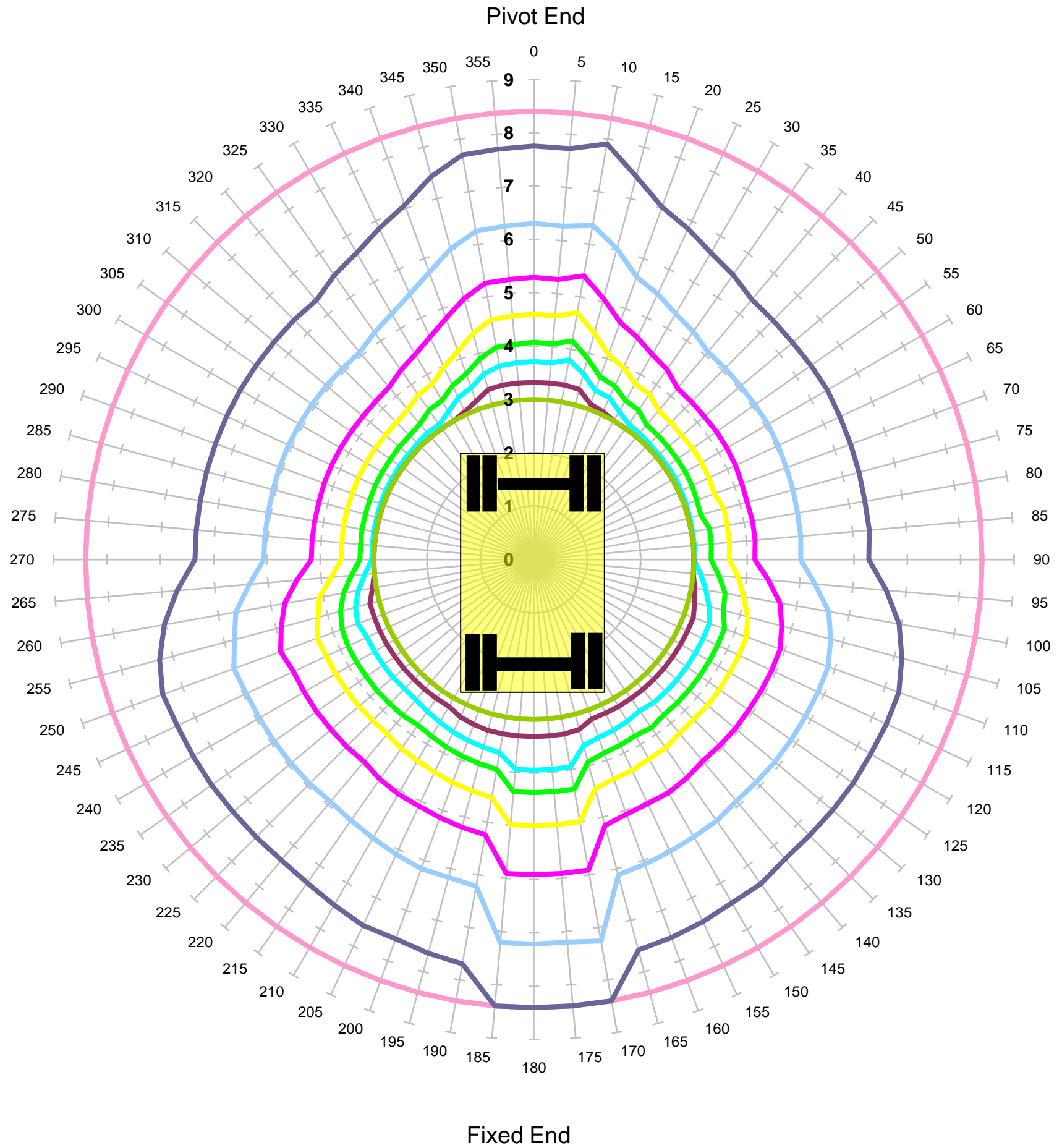

Units in Tonnes

- 1
- 2
- 3
- 4
- 5
- 6
- 7
- 8
- 9
- 10

MACHINE & MODEL:	Komatsu PW160-11	REFERENCE:	3.00m Jib
SERIAL No:	H65493	DATE OF CHART:	12-Sep-2022
EQUIPMENT:	2.00m + 3.47m + 2.50m	SAFETY FACTOR:	71.0%
COMMENT:			

Komatsu PW160-11

**Max Capacity Contours of Radius(m) Plots 2.5m Dipper
Gradient 1 in -25 Height 2m Lift QH
Unlocked Rail Cant -150mm - Tandem Lift**

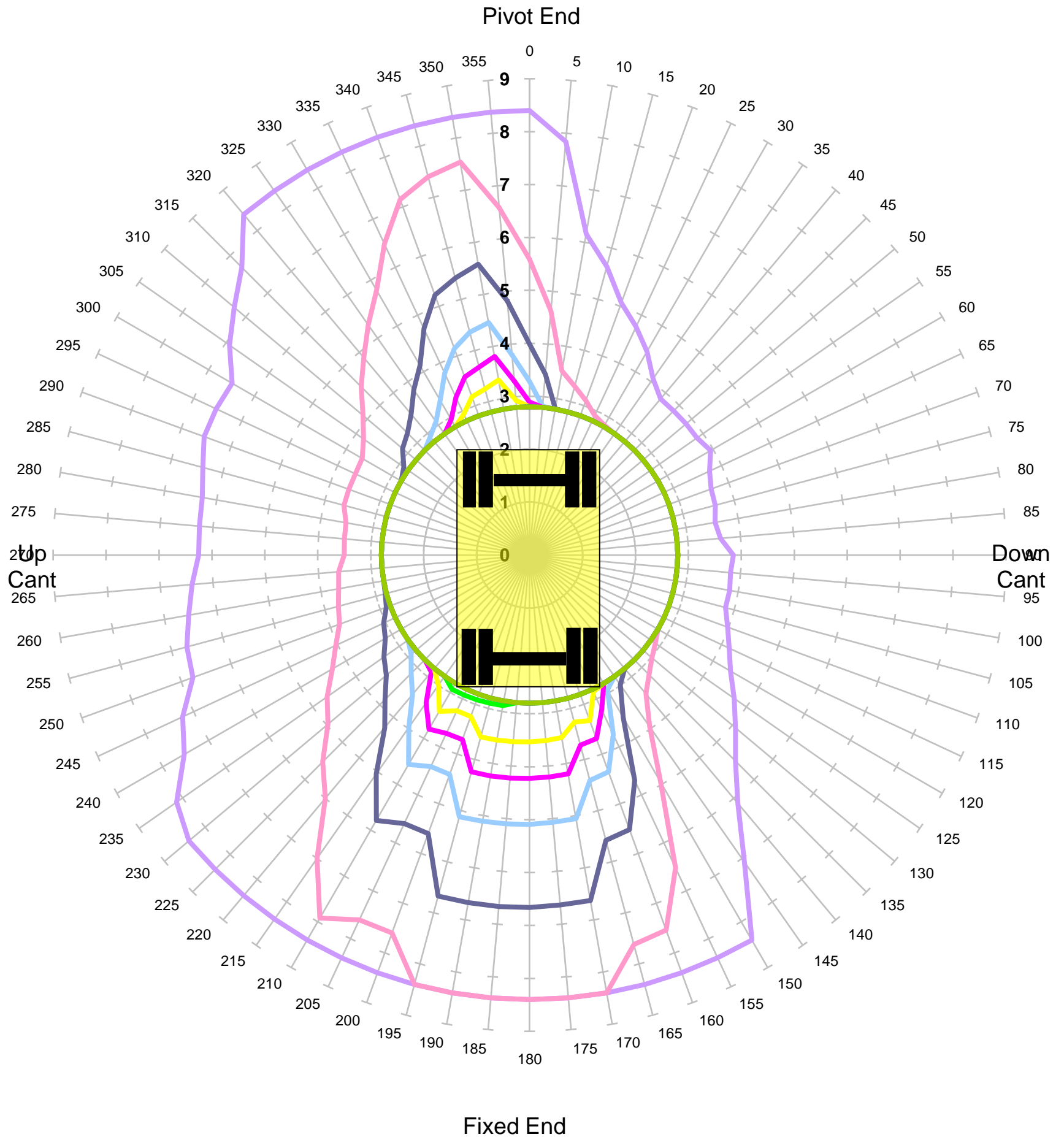

Units in Tonnes

- 1
- 2
- 3
- 4
- 5
- 6
- 7
- 8
- 9
- 10

MACHINE & MODEL:	Komatsu PW160-11	REFERENCE:	3.00m Jib
SERIAL No:	H65493	DATE OF CHART:	12-Sep-2022
EQUIPMENT:	2.00m + 3.47m + 2.50m	SAFETY FACTOR:	44.0%
COMMENT:			

Komatsu PW160-11
Max Capacity Contours of Radius(m) Plots 2.5m Dipper
Gradient 1 in -25 Height 2m Lift QH
Unlocked Rail Cant -50mm - Tandem Lift

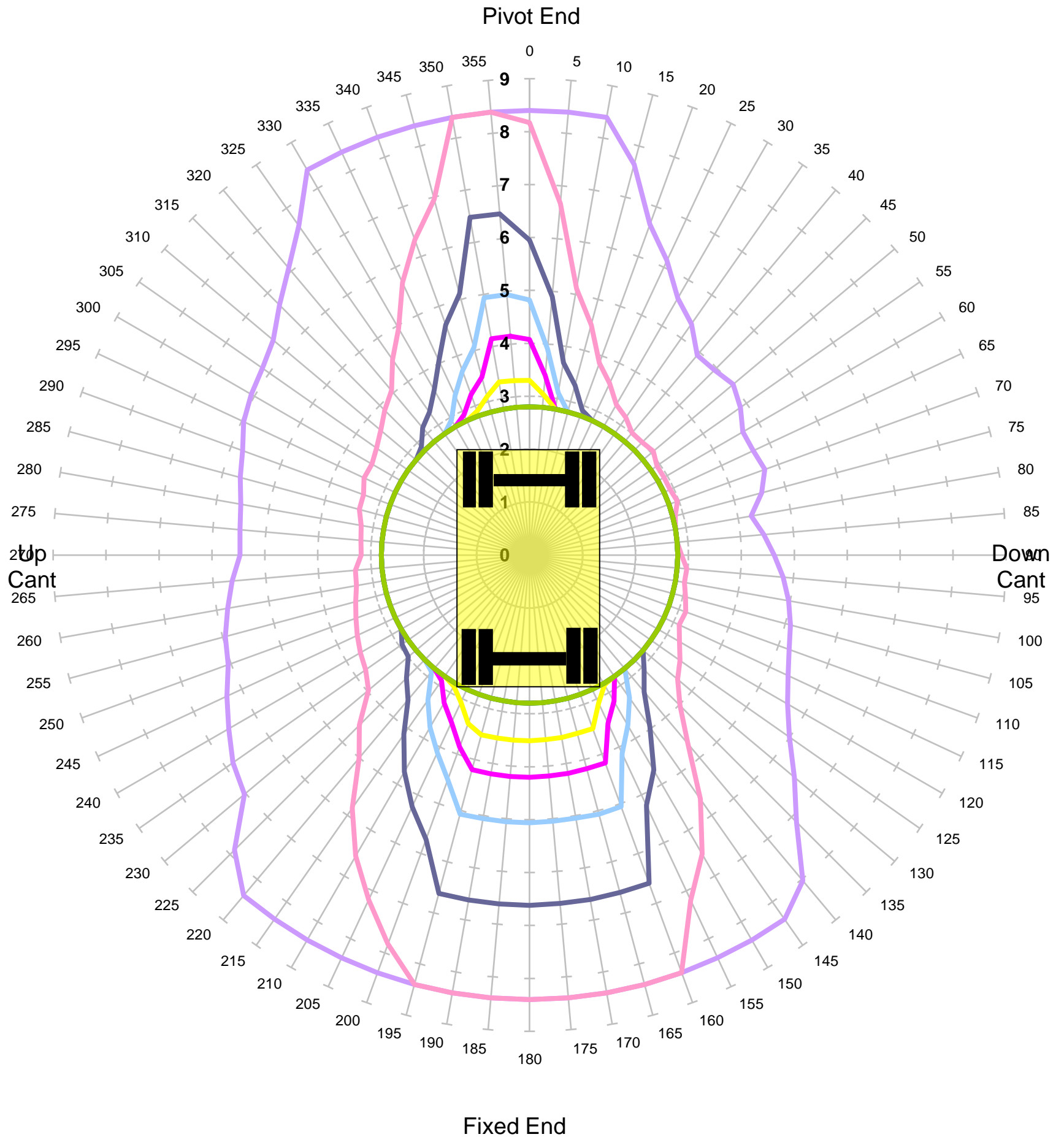

MACHINE & MODEL:	Komatsu PW160-11	REFERENCE:	3.00m Jib
SERIAL No:	H65493	DATE OF CHART:	12-Sep-2022
EQUIPMENT:	2.00m + 3.47m + 2.50m	SAFETY FACTOR:	44.0%
COMMENT:			

Komatsu PW160-11
Max Capacity Contours of Radius(m) Plots 2.5m Dipper
Gradient 1 in -25 Height 2m Lift QH
Unlocked Rail Cant 50mm - Tandem Lift

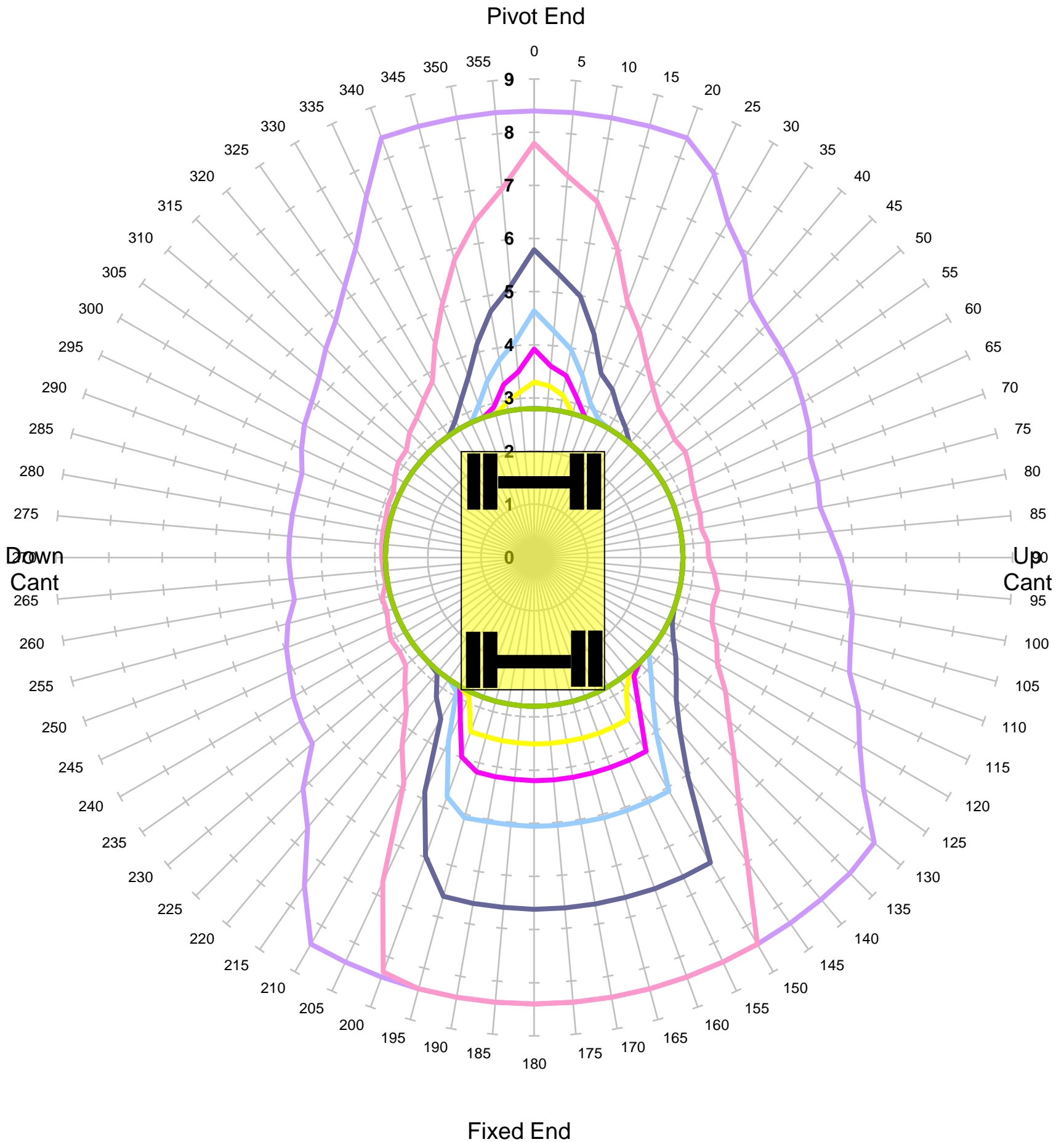

Units in Tonnes

- 1
- 2
- 3
- 4
- 5
- 6
- 7
- 8
- 9
- 10

MACHINE & MODEL:	Komatsu PW160-11	REFERENCE:	3.00m Jib
SERIAL No:	H65493	DATE OF CHART:	12-Sep-2022
EQUIPMENT:	2.00m + 3.47m + 2.50m	SAFETY FACTOR:	44.0%
COMMENT:			

Komatsu PW160-11

**Max Capacity Contours of Radius(m) Plots 2.5m Dipper
Gradient 1 in -25 Height 2m Lift QH
Unlocked Rail Cant 150mm - Tandem Lift**

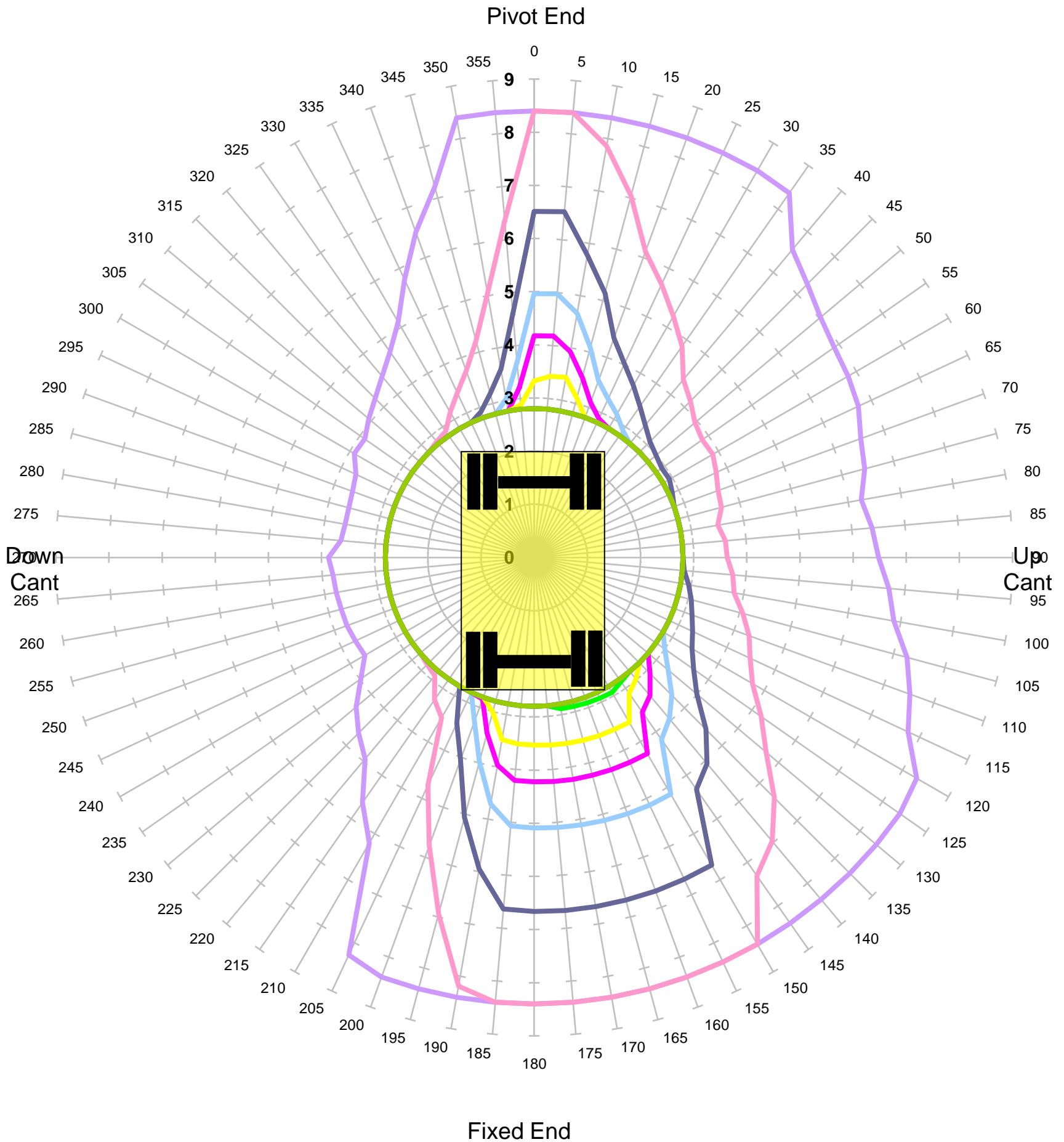

Units in Tonnes

- 1
- 2
- 3
- 4
- 5
- 6
- 7
- 8
- 9
- 10

MACHINE & MODEL:	Komatsu PW160-11	REFERENCE:	3.00m Jib
SERIAL No:	H65493	DATE OF CHART:	12-Sep-2022
EQUIPMENT:	2.00m + 3.47m + 2.50m	SAFETY FACTOR:	44.0%
COMMENT:			

Komatsu PW160-11

**Max Capacity Contours of Radius(m) Plots 2.5m Dipper
Gradient 1 in -25 Height 2m Lift QH
Locked Rail Cant -150mm - Tandem Lift**

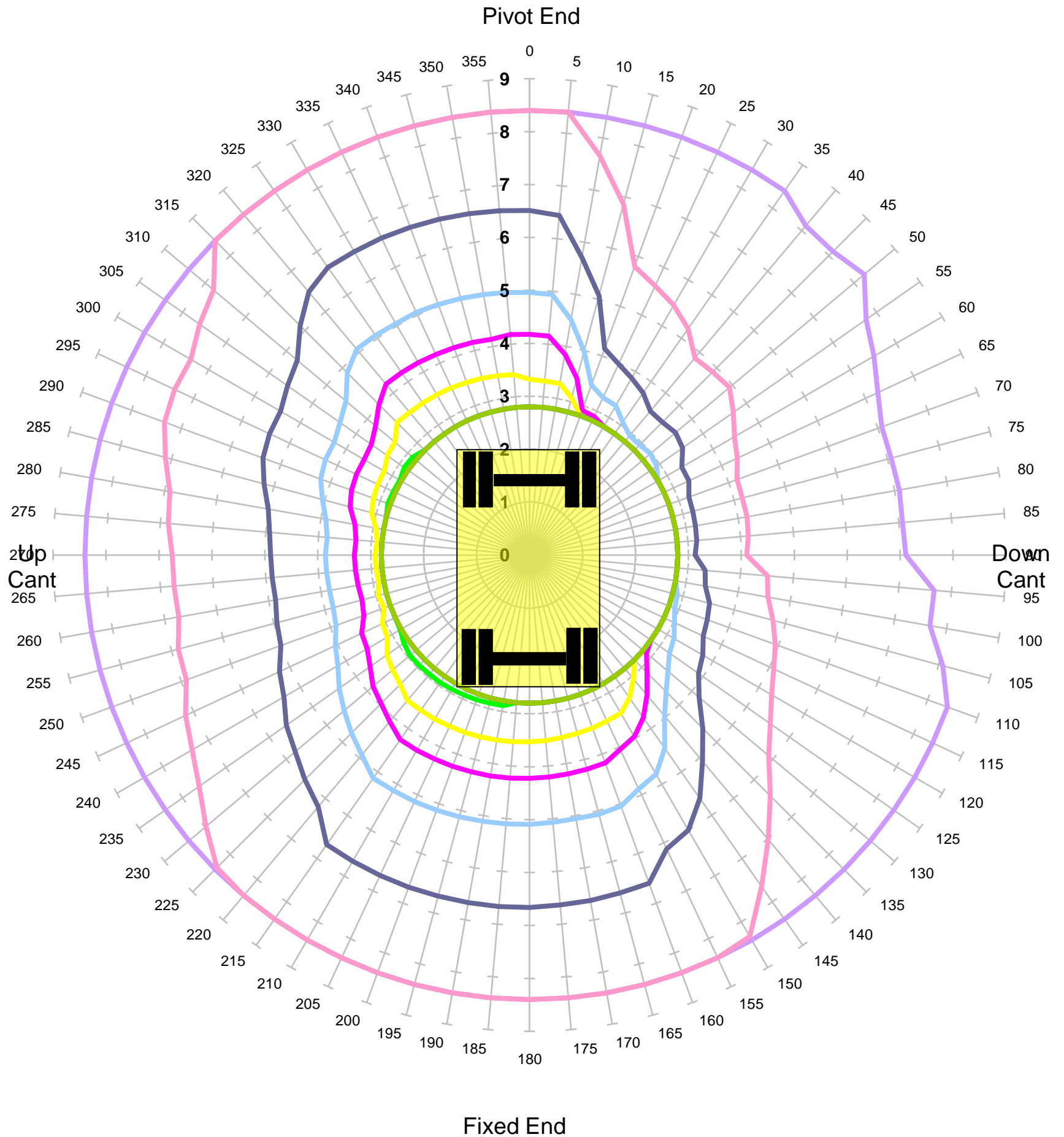

Units in Tonnes

- 1
- 2
- 3
- 4
- 5
- 6
- 7
- 8
- 9
- 10

MACHINE & MODEL:	Komatsu PW160-11	REFERENCE:	3.00m Jib
SERIAL No:	H65493	DATE OF CHART:	12-Sep-2022
EQUIPMENT:	2.00m + 3.47m + 2.50m	SAFETY FACTOR:	59.0%
COMMENT:			

Komatsu PW160-11

**Max Capacity Contours of Radius(m) Plots 2.5m Dipper
Gradient 1 in -25 Height 2m Lift QH
Locked Rail Cant -50mm - Tandem Lift**

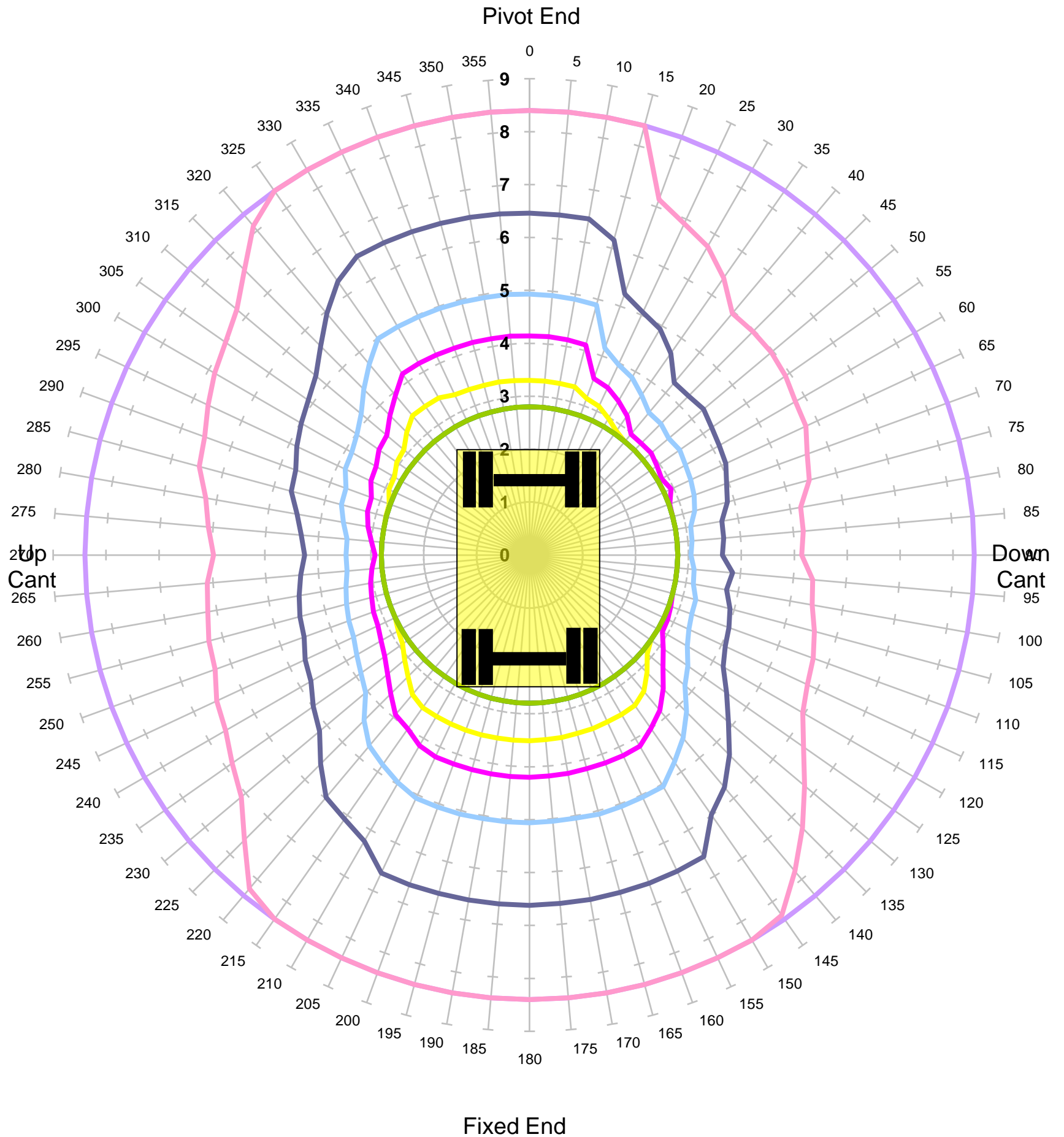

Units in Tonnes

- 1
- 2
- 3
- 4
- 5
- 6
- 7
- 8
- 9
- 10

MACHINE & MODEL:	Komatsu PW160-11	REFERENCE:	3.00m Jib
SERIAL No:	H65493	DATE OF CHART:	12-Sep-2022
EQUIPMENT:	2.00m + 3.47m + 2.50m	SAFETY FACTOR:	59.0%
COMMENT:			

Komatsu PW160-11

**Max Capacity Contours of Radius(m) Plots 2.5m Dipper
Gradient 1 in -25 Height 2m Lift QH
Locked Rail Cant 50mm - Tandem Lift**

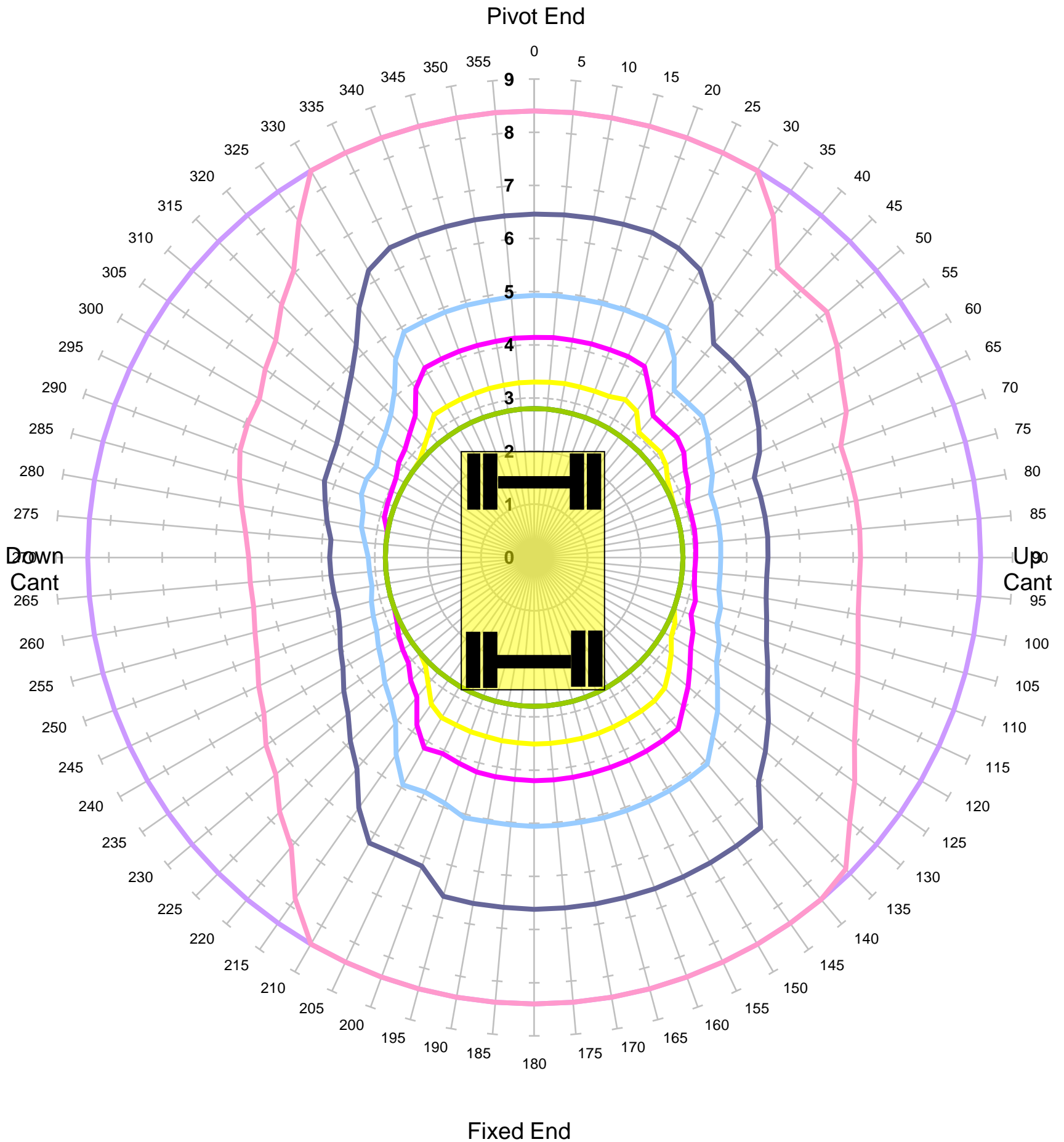

Units in Tonnes

- 1
- 2
- 3
- 4
- 5
- 6
- 7
- 8
- 9
- 10

MACHINE & MODEL:	Komatsu PW160-11	REFERENCE:	3.00m Jib
SERIAL No:	H65493	DATE OF CHART:	12-Sep-2022
EQUIPMENT:	2.00m + 3.47m + 2.50m	SAFETY FACTOR:	59.0%
COMMENT:			

Komatsu PW160-11

**Max Capacity Contours of Radius(m) Plots 2.5m Dipper
Gradient 1 in -25 Height 2m Lift QH
Locked Rail Cant 150mm - Tandem Lift**

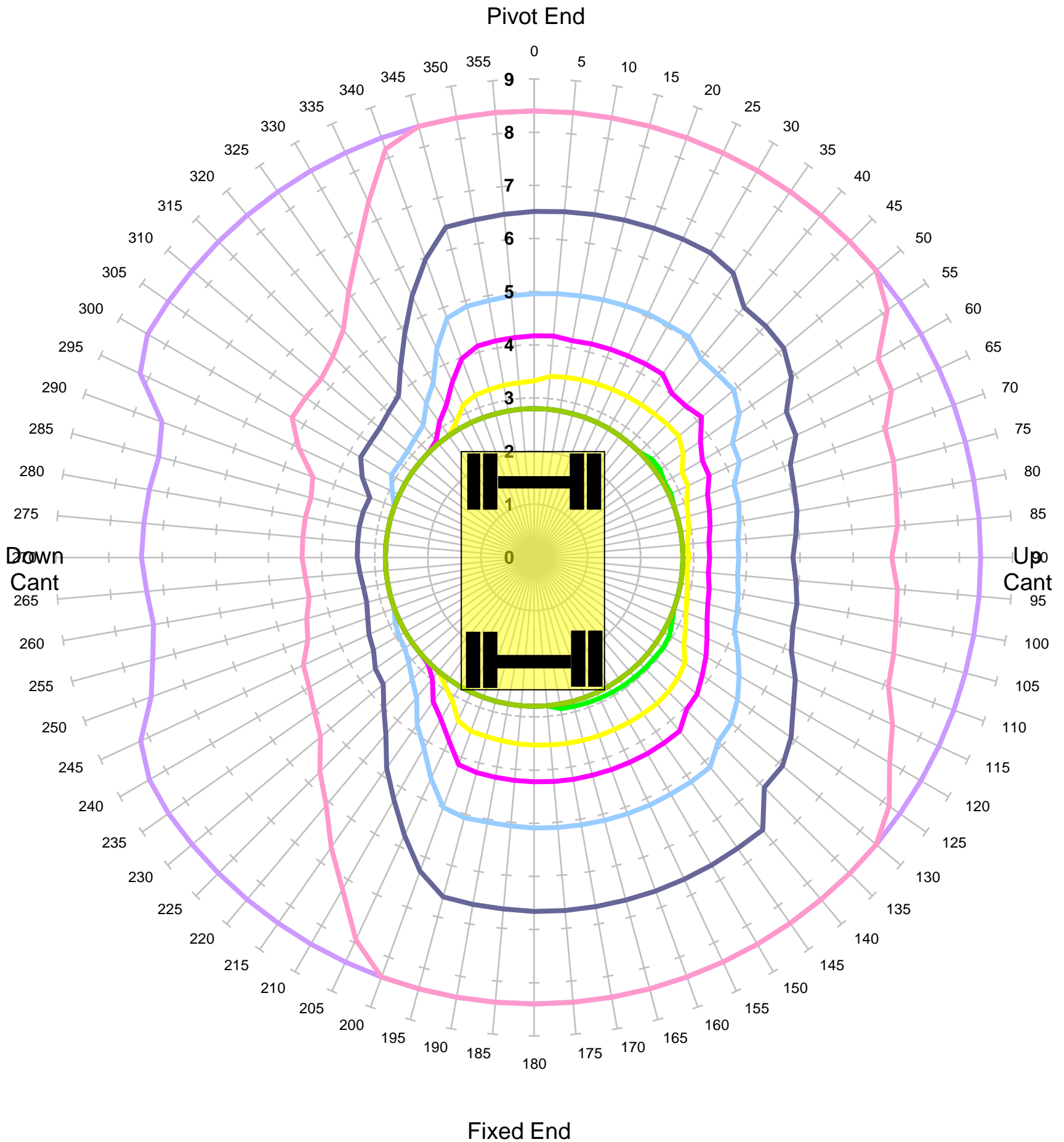

Units in Tonnes

- 1
- 2
- 3
- 4
- 5
- 6
- 7
- 8
- 9
- 10

MACHINE & MODEL:	Komatsu PW160-11	REFERENCE:	3.00m Jib
SERIAL No:	H65493	DATE OF CHART:	12-Sep-2022
EQUIPMENT:	2.00m + 3.47m + 2.50m	SAFETY FACTOR:	59.0%
COMMENT:			

Komatsu PW160-11

**Max Capacity Contours of Radius(m) Plots 2.5m Dipper
Level Ground Height 2m Lift QH
Unlocked Road - Tandem Lift**

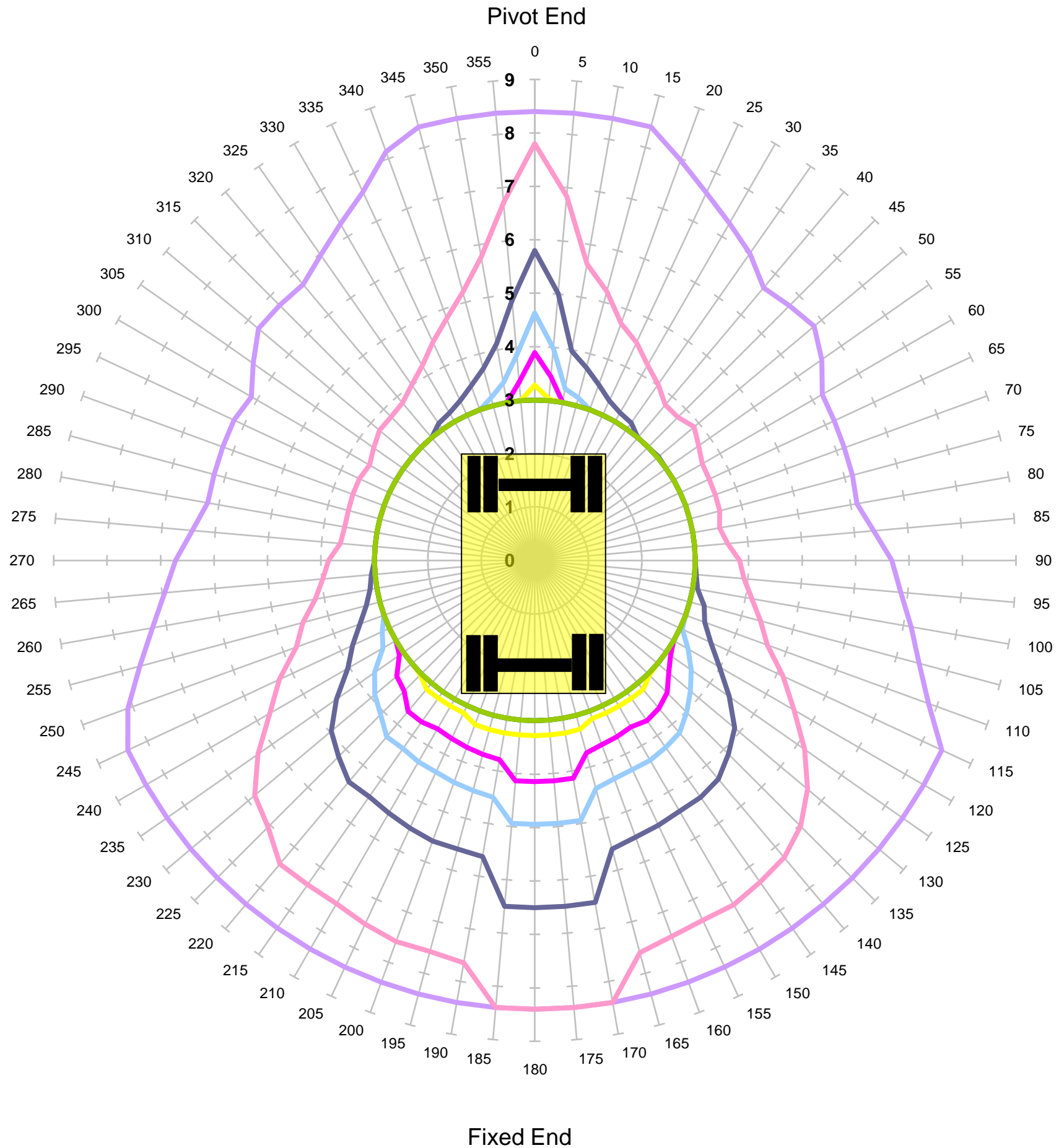

Units in Tonnes

- 1
- 2
- 3
- 4
- 5
- 6
- 7
- 8
- 9
- 10

MACHINE & MODEL:	Komatsu PW160-11	REFERENCE:	3.00m Jib
SERIAL No:	H65493	DATE OF CHART:	12-Sep-2022
EQUIPMENT:	2.00m + 3.47m + 2.50m	SAFETY FACTOR:	47.0%
COMMENT:			

Komatsu PW160-11
Max Capacity Contours of Radius(m) Plots 2.5m Dipper
Level Ground Height 2m Lift QH
Locked Road - Tandem Lift

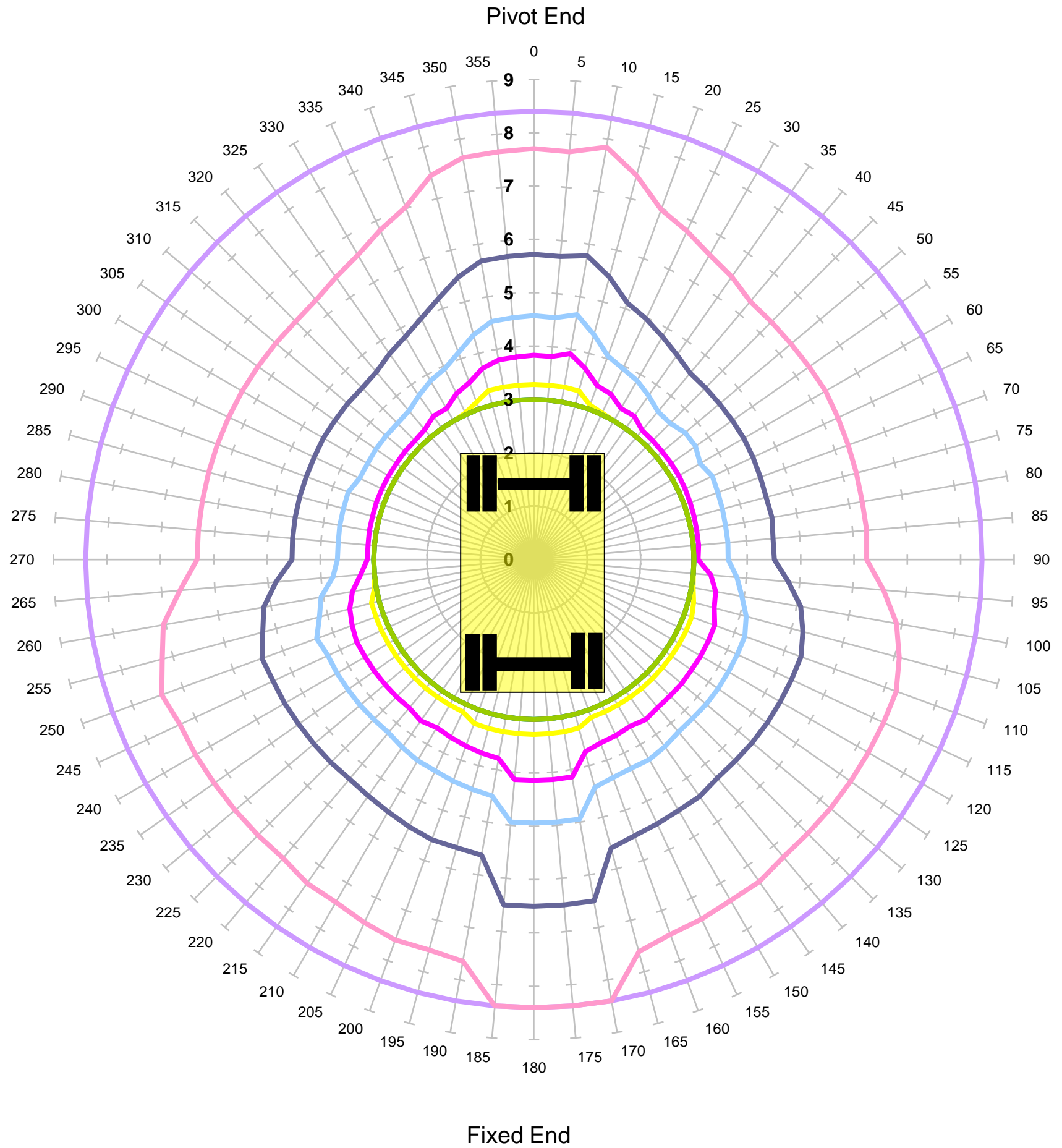

Units in Tonnes

- 1
- 2
- 3
- 4
- 5
- 6
- 7
- 8
- 9
- 10

MACHINE & MODEL:	Komatsu PW160-11	REFERENCE:	3.00m Jib
SERIAL No:	H65493	DATE OF CHART:	12-Sep-2022
EQUIPMENT:	2.00m + 3.47m + 2.50m	SAFETY FACTOR:	47.0%
COMMENT:			

Komatsu PW160-11

**Max Capacity Contours of Radius(m) Plots 2.5m Dipper 3.0m Jib
Gradient 1 in -25 Height 2m Lift JIBLP
Unlocked Rail Cant -150mm**

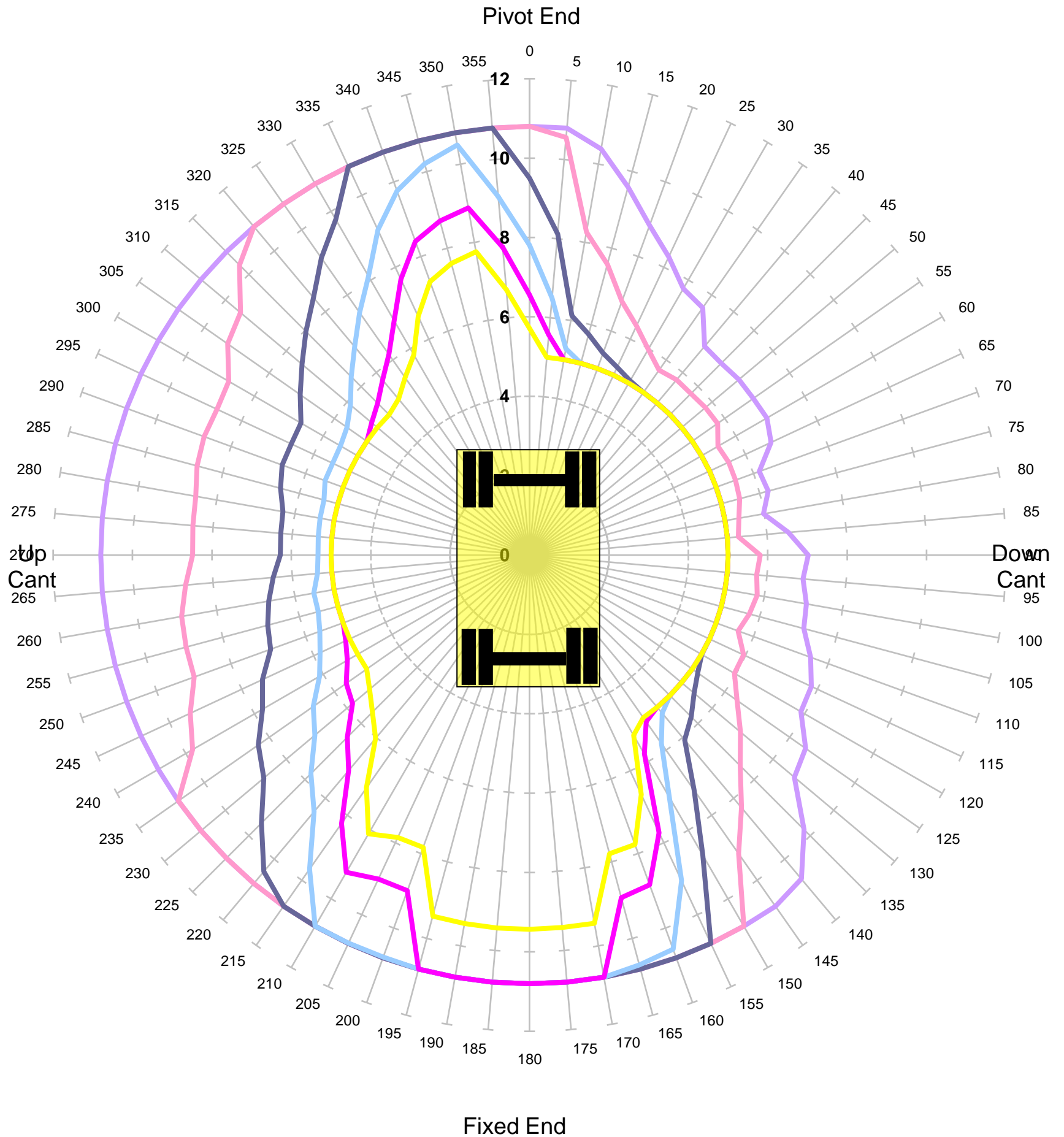

Units in Tonnes

— 0.5
 — 1
 — 1.5
 — 2
 — 2.5
 — 3

MACHINE & MODEL:	Komatsu PW160-11	REFERENCE:	3.00m Jib
SERIAL No:	H65493	DATE OF CHART:	12-Sep-2022
EQUIPMENT:	2.00m + 3.47m + 2.50m	SAFETY FACTOR:	67.0%
COMMENT:			

Komatsu PW160-11

**Max Capacity Contours of Radius(m) Plots 2.5m Dipper 3.0m Jib
Gradient 1 in -25 Height 2m Lift JIBLP
Unlocked Rail Cant -50mm**

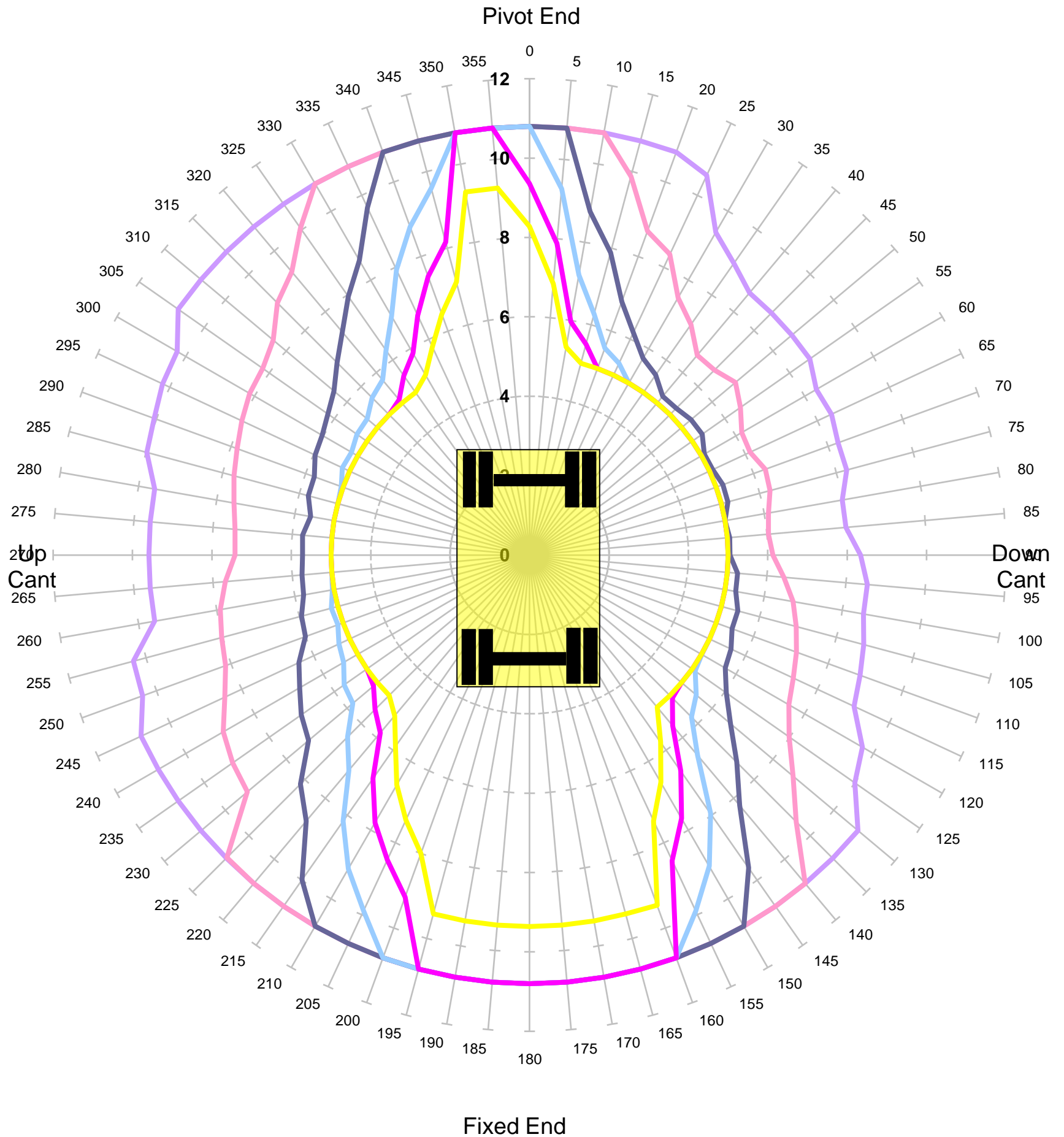

Units in Tonnes

— 0.5
 — 1
 — 1.5
 — 2
 — 2.5
 — 3

MACHINE & MODEL:	Komatsu PW160-11	REFERENCE:	3.00m Jib
SERIAL No:	H65493	DATE OF CHART:	12-Sep-2022
EQUIPMENT:	2.00m + 3.47m + 2.50m	SAFETY FACTOR:	67.0%
COMMENT:			

Komatsu PW160-11

**Max Capacity Contours of Radius(m) Plots 2.5m Dipper 3.0m Jib
Gradient 1 in -25 Height 2m Lift JIBLP
Unlocked Rail Cant 50mm**

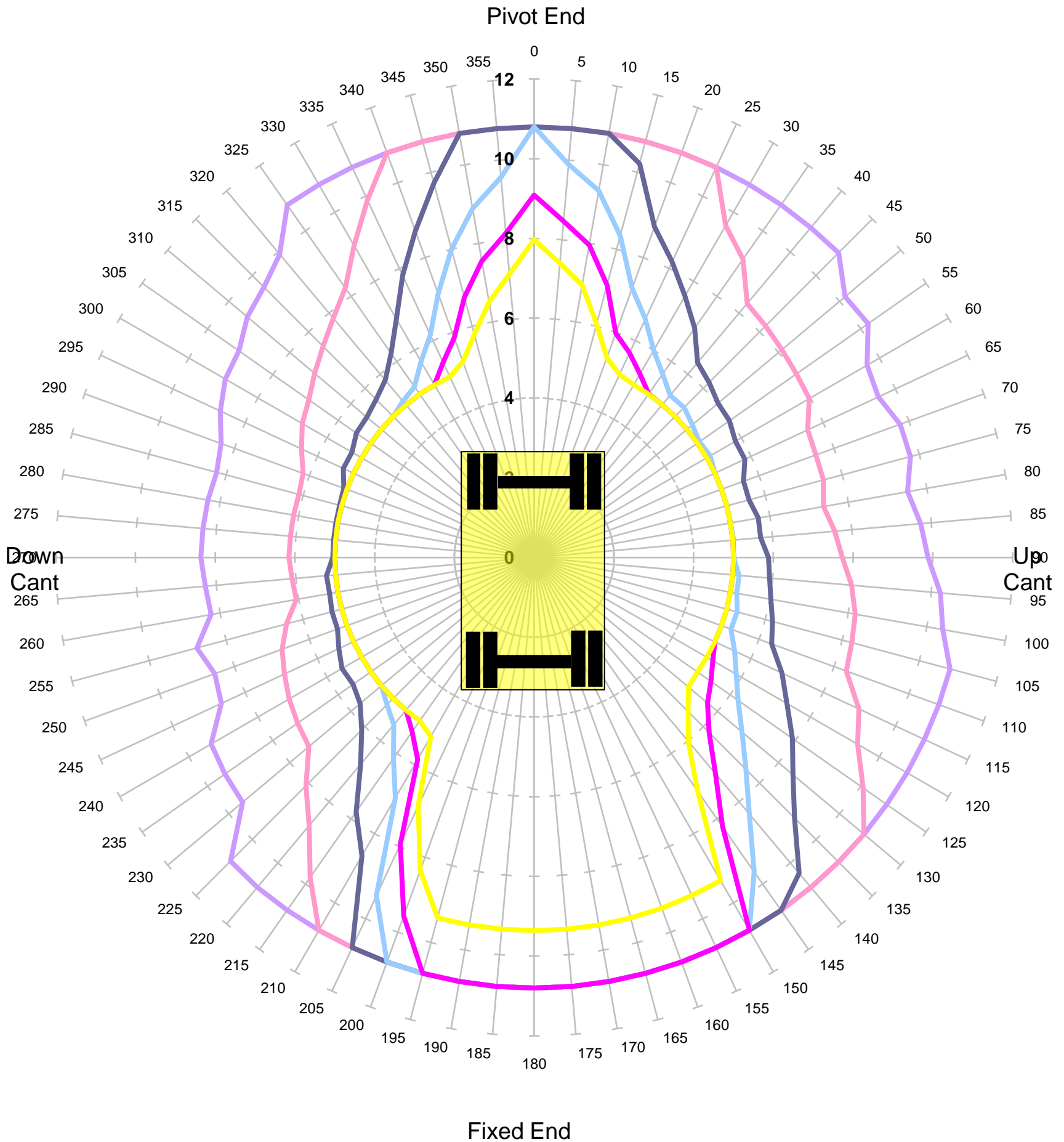

Units in Tonnes

- 0.5
- 1
- 1.5
- 2
- 2.5
- 3

MACHINE & MODEL:	Komatsu PW160-11	REFERENCE:	3.00m Jib
SERIAL No:	H65493	DATE OF CHART:	12-Sep-2022
EQUIPMENT:	2.00m + 3.47m + 2.50m	SAFETY FACTOR:	67.0%
COMMENT:			

Komatsu PW160-11

**Max Capacity Contours of Radius(m) Plots 2.5m Dipper 3.0m Jib
Gradient 1 in -25 Height 2m Lift JIBLP
Unlocked Rail Cant 150mm**

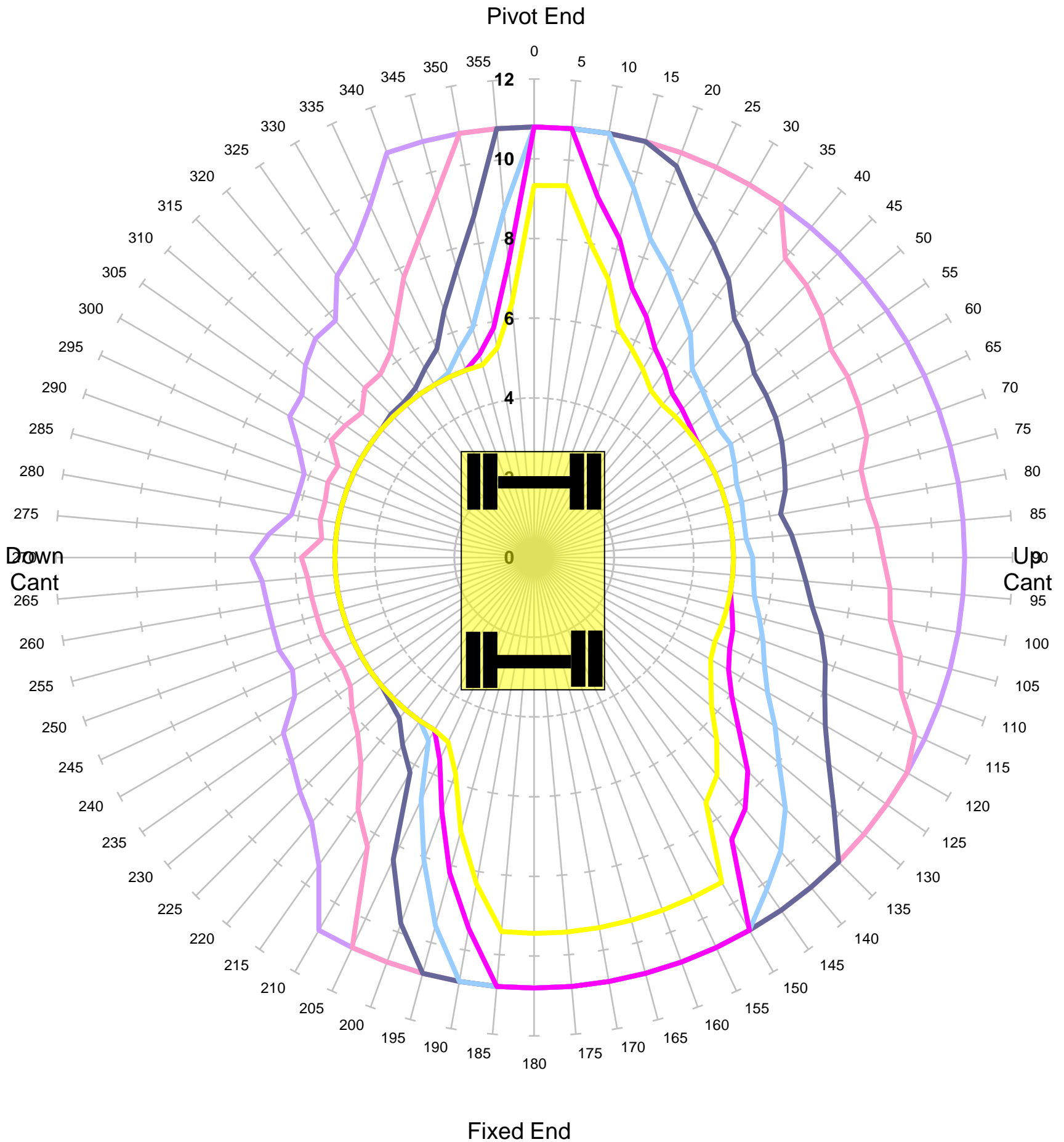

Units in Tonnes

— 0.5
 — 1
 — 1.5
 — 2
 — 2.5
 — 3

MACHINE & MODEL:	Komatsu PW160-11	REFERENCE:	3.00m Jib
SERIAL No:	H65493	DATE OF CHART:	12-Sep-2022
EQUIPMENT:	2.00m + 3.47m + 2.50m	SAFETY FACTOR:	67.0%
COMMENT:			

Komatsu PW160-11

**Max Capacity Contours of Radius(m) Plots 2.5m Dipper 3.0m Jib
Gradient 1 in -25 Height 2m Lift JIBLP
Locked Rail Cant -150mm**

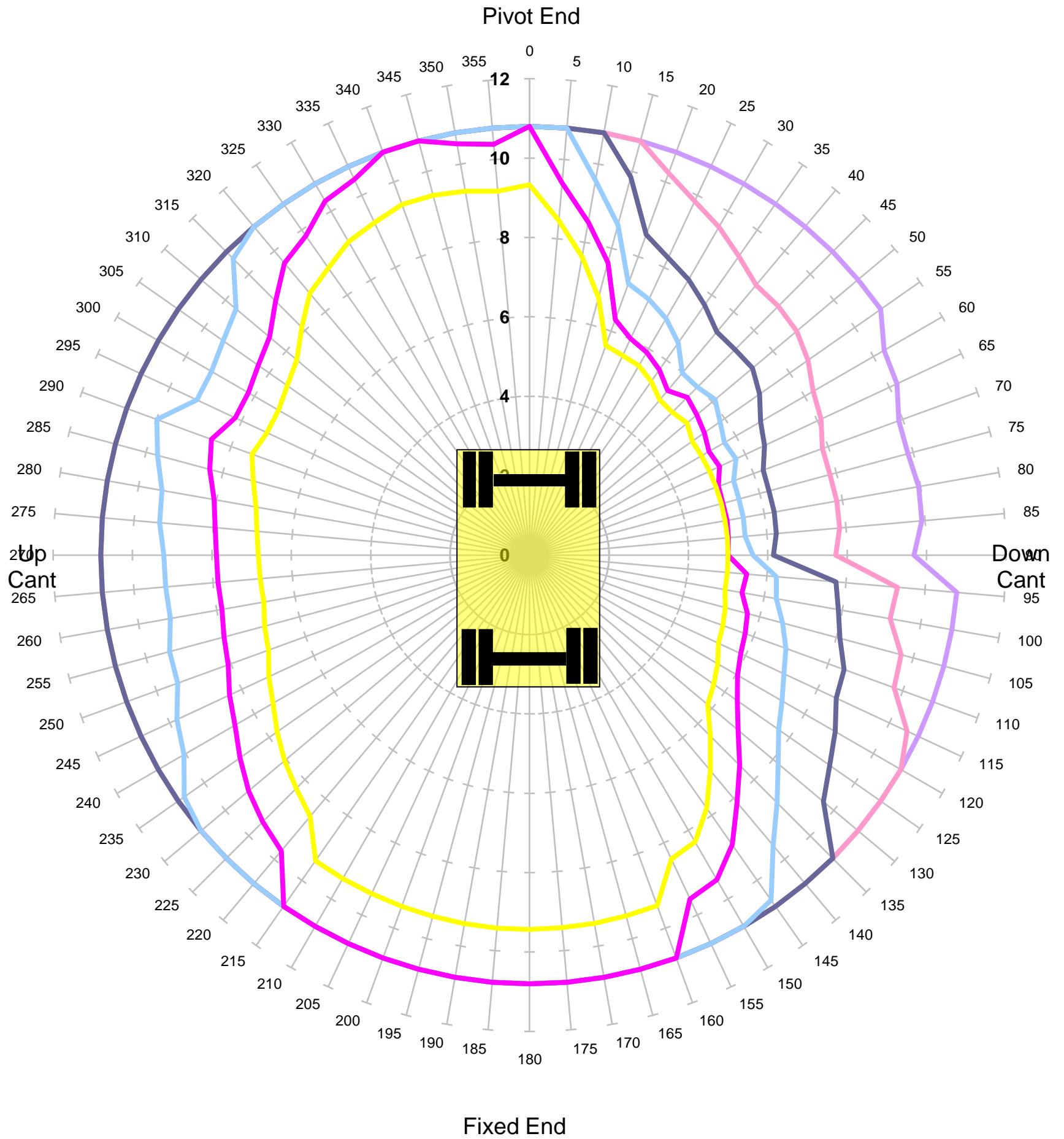

Units in Tonnes

— 0.5 — 1 — 1.5 — 2 — 2.5 — 3

MACHINE & MODEL:	Komatsu PW160-11	REFERENCE:	3.00m Jib
SERIAL No:	H65493	DATE OF CHART:	12-Sep-2022
EQUIPMENT:	2.00m + 3.47m + 2.50m	SAFETY FACTOR:	90.0%
COMMENT:			

Komatsu PW160-11

**Max Capacity Contours of Radius(m) Plots 2.5m Dipper 3.0m Jib
Gradient 1 in -25 Height 2m Lift JIBLP
Locked Rail Cant -50mm**

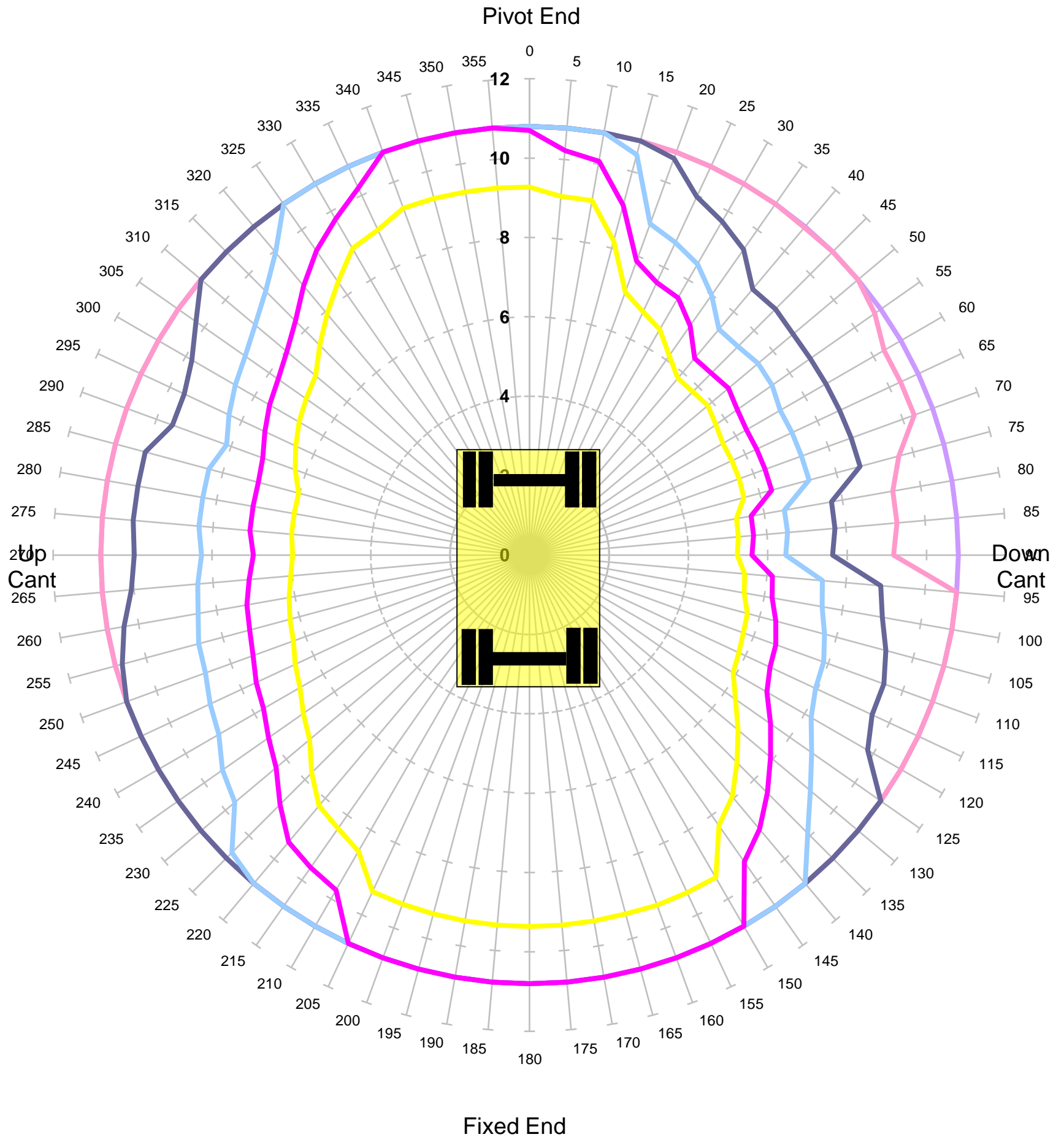

Units in Tonnes

— 0.5
 — 1
 — 1.5
 — 2
 — 2.5
 — 3

MACHINE & MODEL:	Komatsu PW160-11	REFERENCE:	3.00m Jib
SERIAL No:	H65493	DATE OF CHART:	12-Sep-2022
EQUIPMENT:	2.00m + 3.47m + 2.50m	SAFETY FACTOR:	90.0%
COMMENT:			

Komatsu PW160-11

Max Capacity Contours of Radius(m) Plots 2.5m Dipper 3.0m Jib
Gradient 1 in -25 Height 2m Lift JIBLP
Locked Rail Cant 50mm

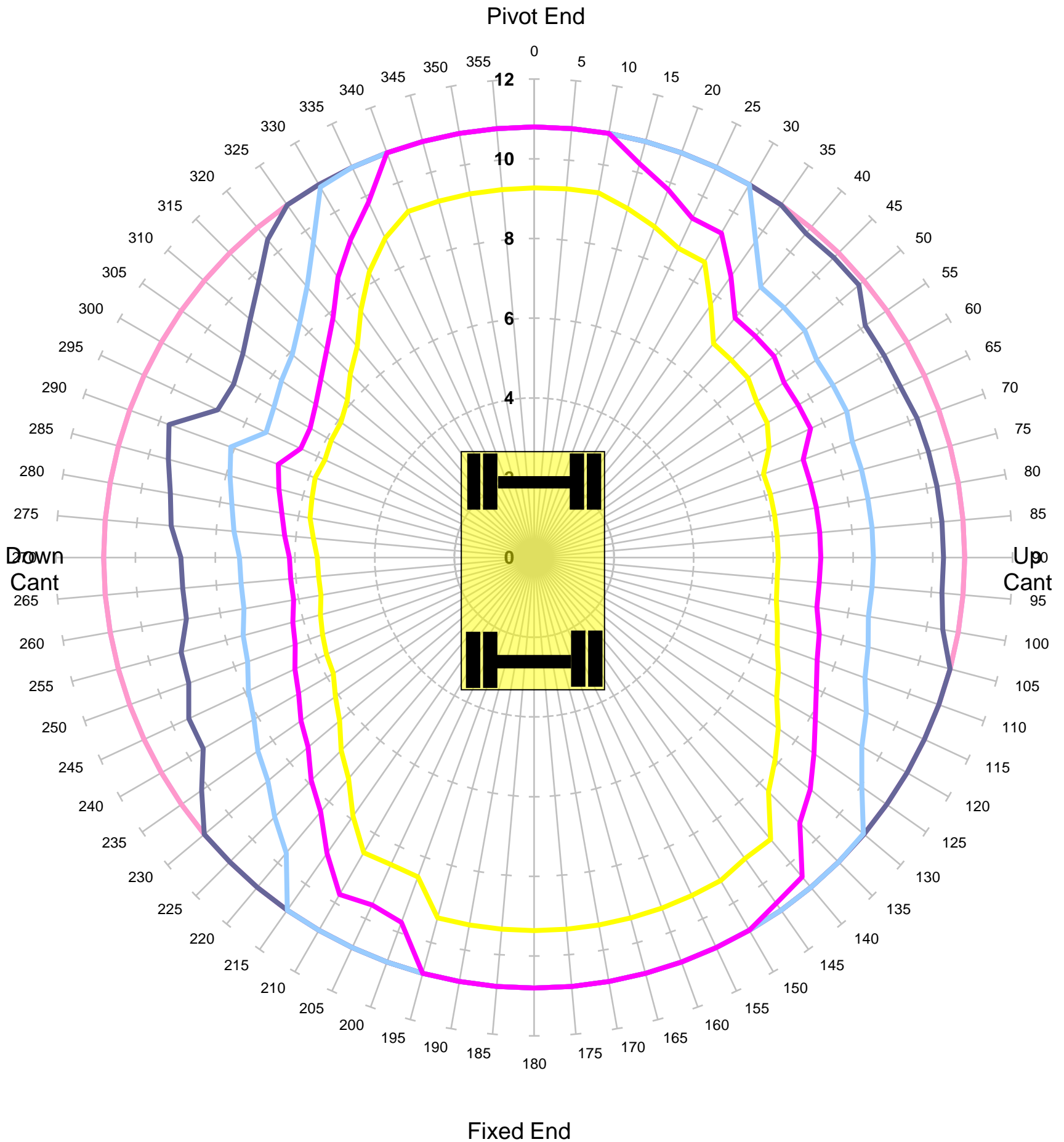

Units in Tonnes

- 0.5
- 1
- 1.5
- 2
- 2.5
- 3

MACHINE & MODEL:	Komatsu PW160-11	REFERENCE:	3.00m Jib
SERIAL No:	H65493	DATE OF CHART:	12-Sep-2022
EQUIPMENT:	2.00m + 3.47m + 2.50m	SAFETY FACTOR:	90.0%
COMMENT:			

Komatsu PW160-11

**Max Capacity Contours of Radius(m) Plots 2.5m Dipper 3.0m Jib
Gradient 1 in -25 Height 2m Lift JIBLP
Locked Rail Cant 150mm**

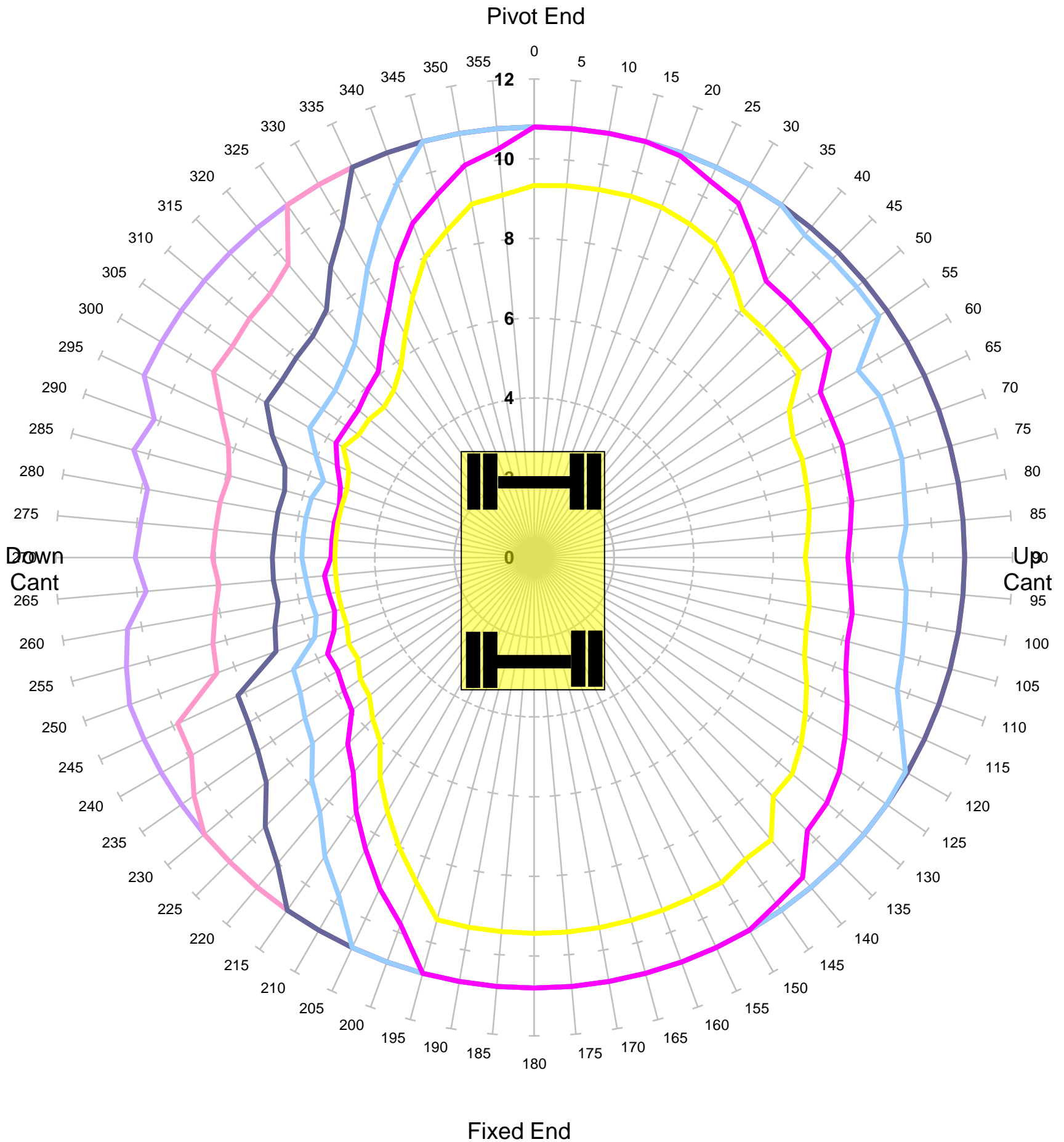

Units in Tonnes

- 0.5
- 1
- 1.5
- 2
- 2.5
- 3

MACHINE & MODEL:	Komatsu PW160-11	REFERENCE:	3.00m Jib
SERIAL No:	H65493	DATE OF CHART:	12-Sep-2022
EQUIPMENT:	2.00m + 3.47m + 2.50m	SAFETY FACTOR:	90.0%
COMMENT:			

Komatsu PW160-11

**Max Capacity Contours of Radius(m) Plots 2.5m Dipper 3.0m Jib
Level Ground Height 2m Lift JIBLP
Unlocked Road**

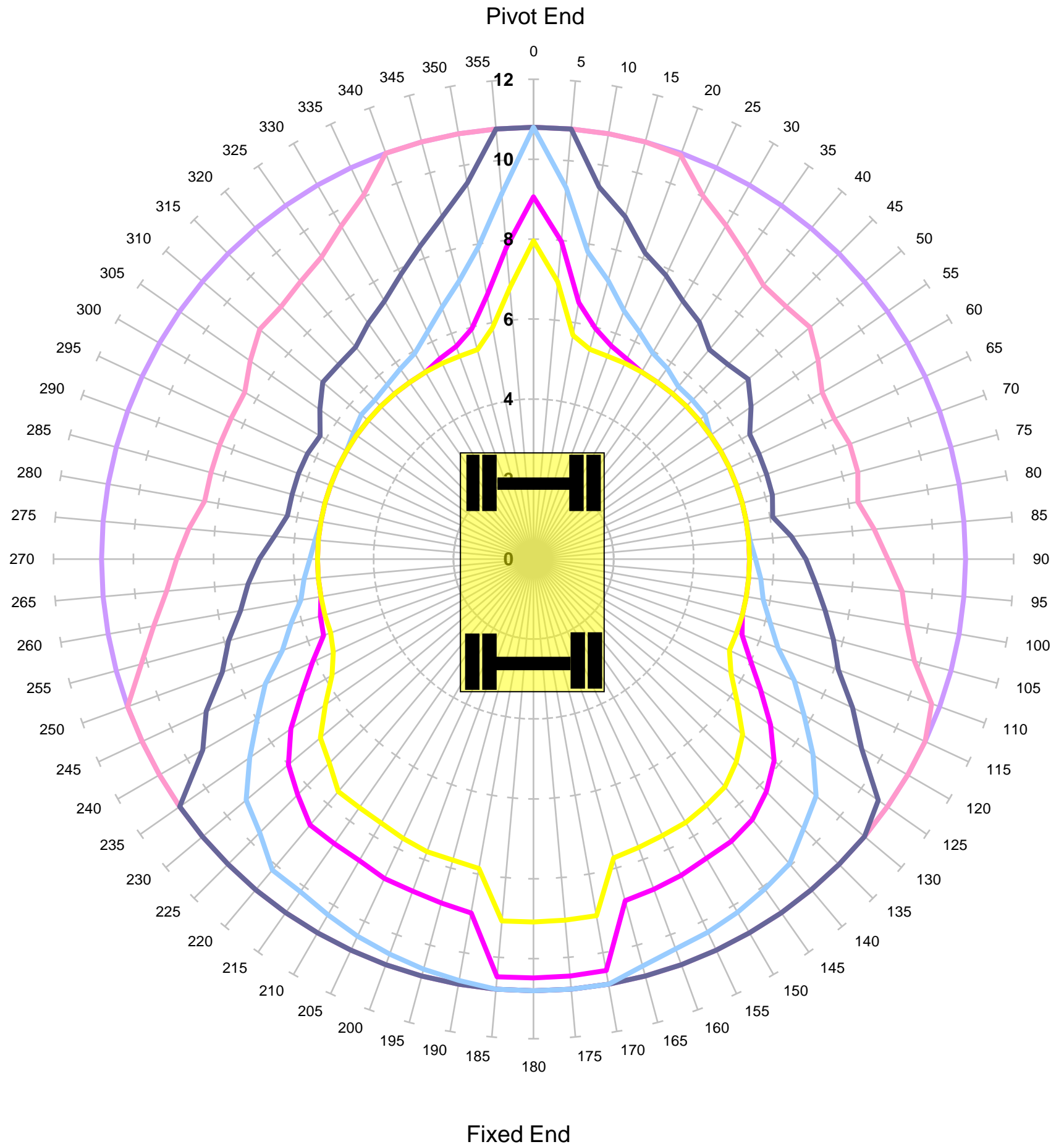

Units in Tonnes

— 0.5
 — 1
 — 1.5
 — 2
 — 2.5
 — 3

MACHINE & MODEL:	Komatsu PW160-11	REFERENCE:	3.00m Jib
SERIAL No:	H65493	DATE OF CHART:	12-Sep-2022
EQUIPMENT:	2.00m + 3.47m + 2.50m	SAFETY FACTOR:	71.0%
COMMENT:			

Komatsu PW160-11

**Max Capacity Contours of Radius(m) Plots 2.5m Dipper 3.0m Jib
Level Ground Height 2m Lift JIBLP
Locked Road**

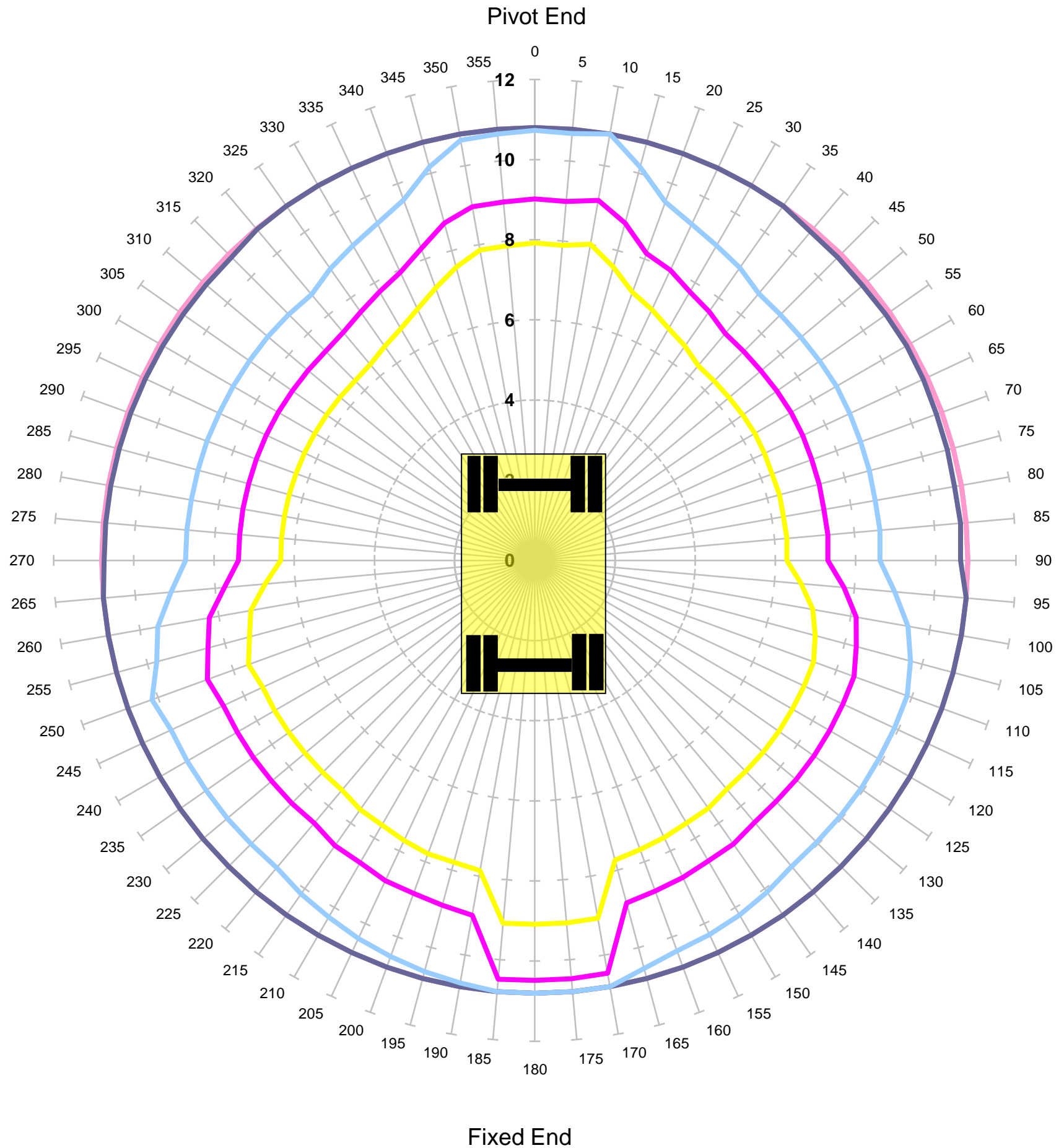

Units in Tonnes

— 0.5
 — 1
 — 1.5
 — 2
 — 2.5
 — 3

MACHINE & MODEL:	Komatsu PW160-11	REFERENCE:	3.00m Jib
SERIAL No:	H65493	DATE OF CHART:	12-Sep-2022
EQUIPMENT:	2.00m + 3.47m + 2.50m	SAFETY FACTOR:	71.0%
COMMENT:			

Komatsu PW160-11

**Max Capacity Contours of Radius(m) Plots 2.5m Dipper 3.0m Jib
Gradient 1 in -25 Height 2m Lift JIBLP
Unlocked Rail Cant -150mm - Tandem Lift**

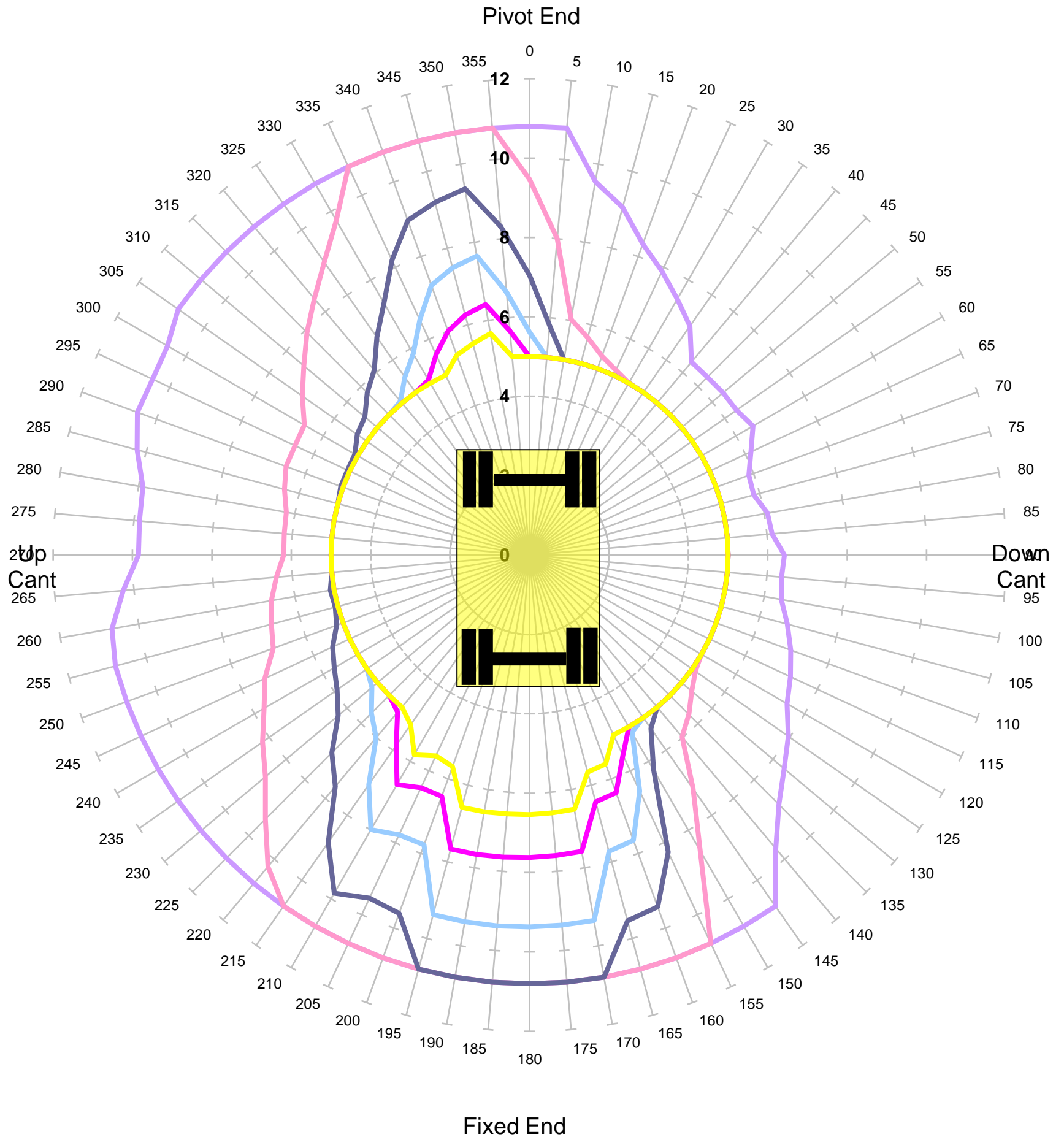

Units in Tonnes

— 0.5
 — 1
 — 1.5
 — 2
 — 2.5
 — 3

MACHINE & MODEL:	Komatsu PW160-11	REFERENCE:	3.00m Jib
SERIAL No:	H65493	DATE OF CHART:	12-Sep-2022
EQUIPMENT:	2.00m + 3.47m + 2.50m	SAFETY FACTOR:	44.0%
COMMENT:			

Komatsu PW160-11

Max Capacity Contours of Radius(m) Plots 2.5m Dipper 3.0m Jib
Gradient 1 in -25 Height 2m Lift JIBLP
Unlocked Rail Cant -50mm - Tandem Lift

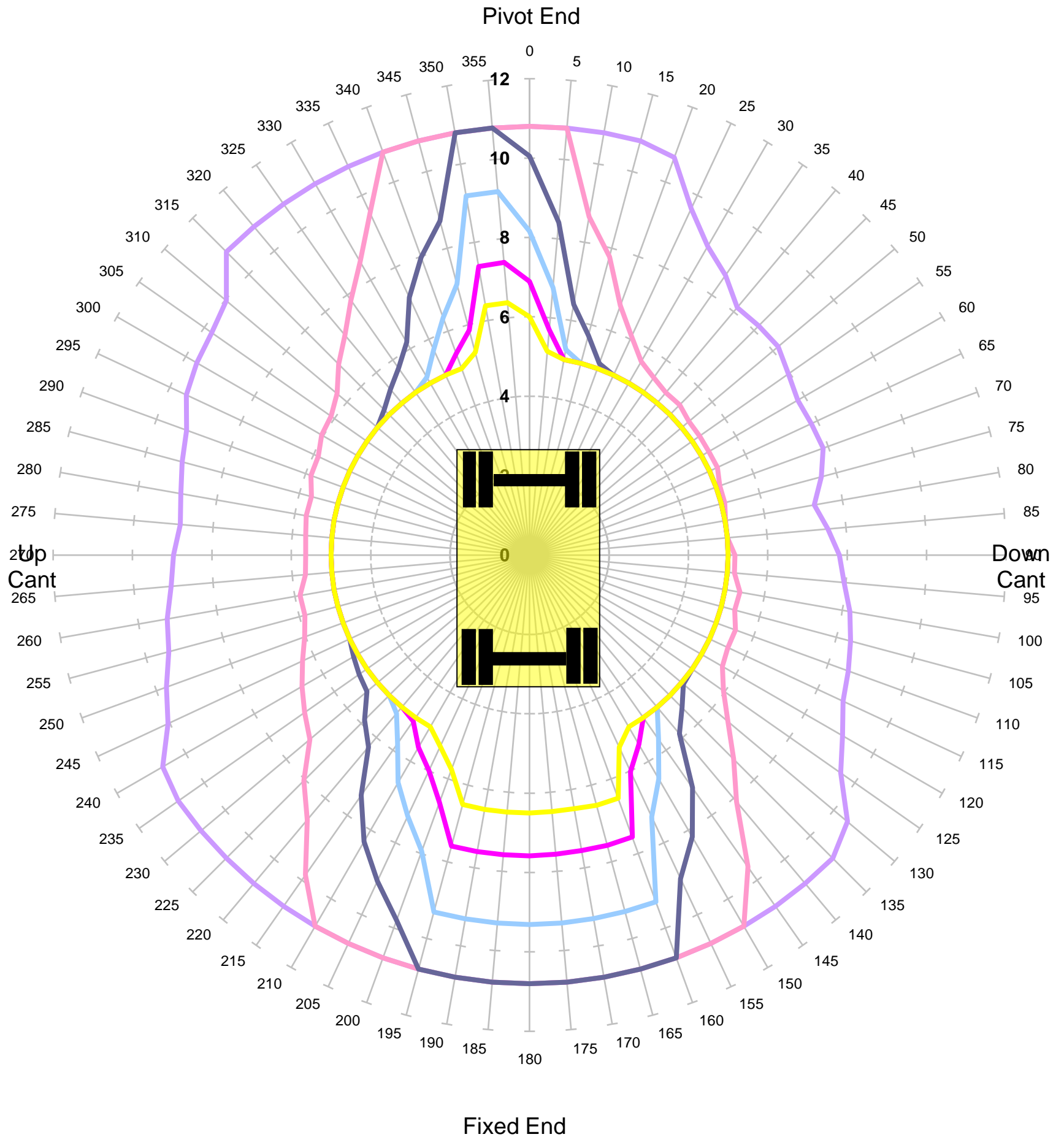

Units in Tonnes

- 0.5
- 1
- 1.5
- 2
- 2.5
- 3

MACHINE & MODEL:	Komatsu PW160-11	REFERENCE:	3.00m Jib
SERIAL No:	H65493	DATE OF CHART:	12-Sep-2022
EQUIPMENT:	2.00m + 3.47m + 2.50m	SAFETY FACTOR:	44.0%
COMMENT:			

Komatsu PW160-11

**Max Capacity Contours of Radius(m) Plots 2.5m Dipper 3.0m Jib
Gradient 1 in -25 Height 2m Lift JIBLP
Unlocked Rail Cant 50mm - Tandem Lift**

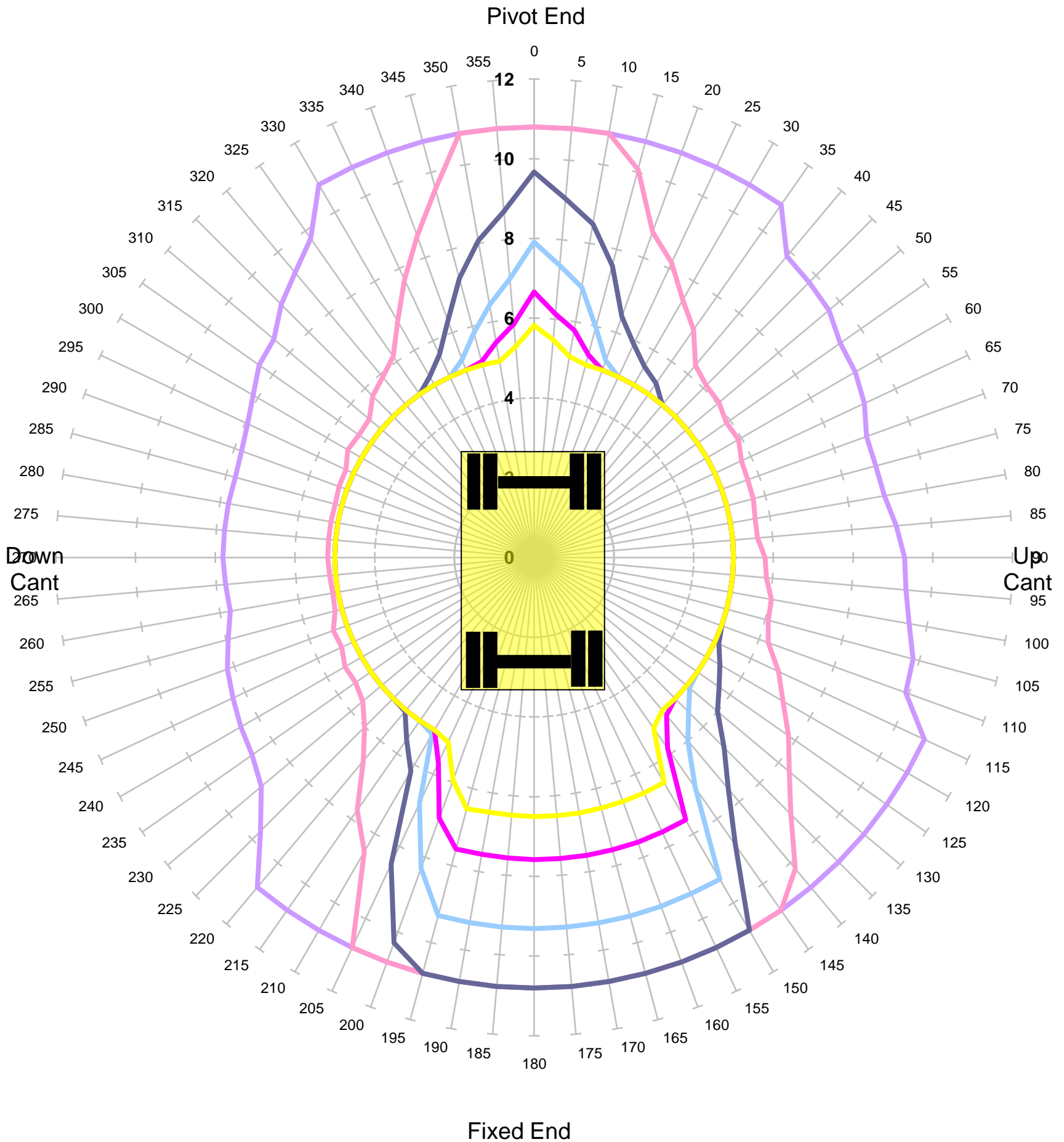

Units in Tonnes

- 0.5
- 1
- 1.5
- 2
- 2.5
- 3

MACHINE & MODEL:	Komatsu PW160-11	REFERENCE:	3.00m Jib
SERIAL No:	H65493	DATE OF CHART:	12-Sep-2022
EQUIPMENT:	2.00m + 3.47m + 2.50m	SAFETY FACTOR:	44.0%
COMMENT:			

Komatsu PW160-11

**Max Capacity Contours of Radius(m) Plots 2.5m Dipper 3.0m Jib
Gradient 1 in -25 Height 2m Lift JIBLP
Unlocked Rail Cant 150mm - Tandem Lift**

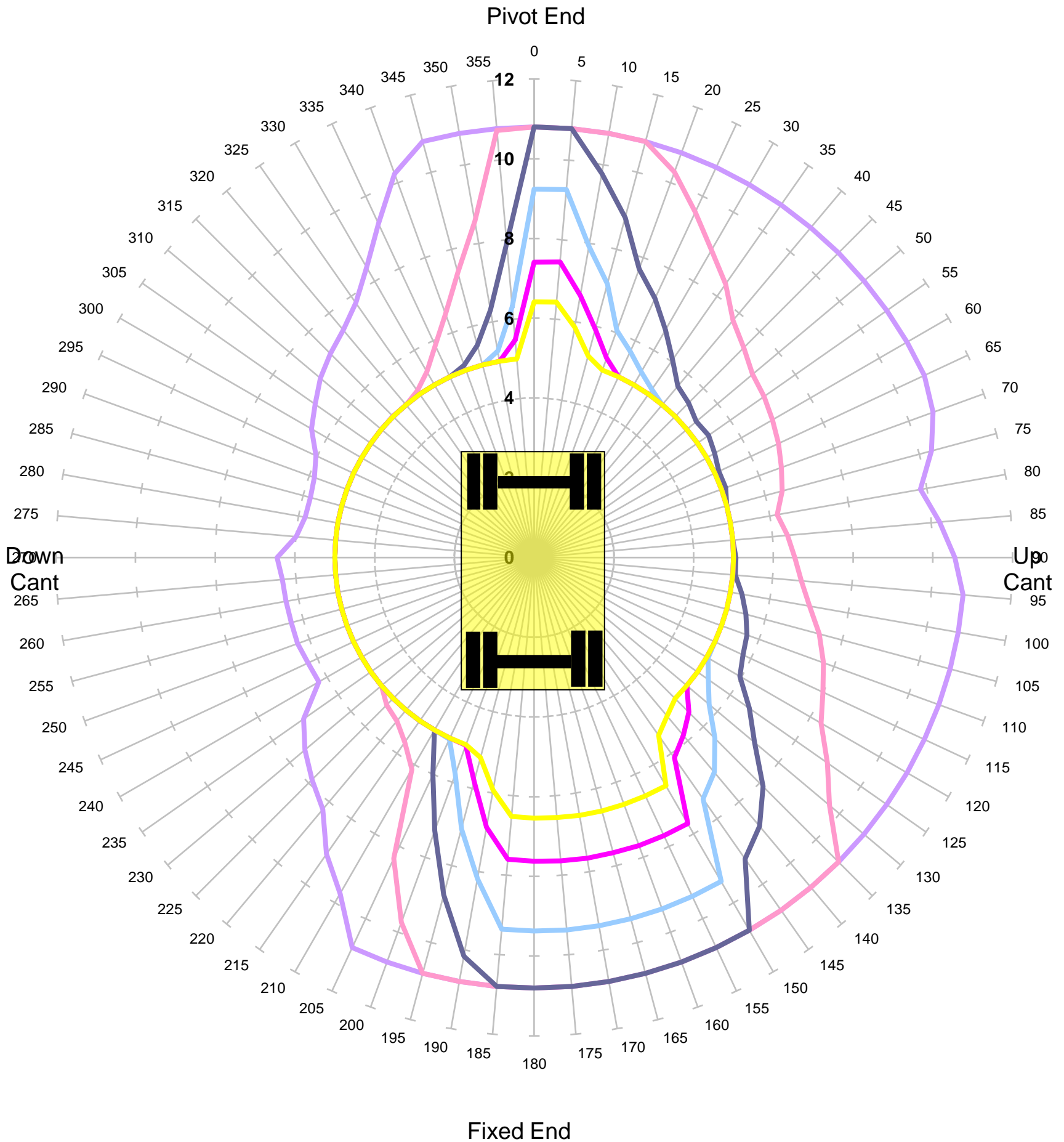

Units in Tonnes

— 0.5
 — 1
 — 1.5
 — 2
 — 2.5
 — 3

MACHINE & MODEL:	Komatsu PW160-11	REFERENCE:	3.00m Jib
SERIAL No:	H65493	DATE OF CHART:	12-Sep-2022
EQUIPMENT:	2.00m + 3.47m + 2.50m	SAFETY FACTOR:	44.0%
COMMENT:			

Komatsu PW160-11

**Max Capacity Contours of Radius(m) Plots 2.5m Dipper 3.0m Jib
Gradient 1 in -25 Height 2m Lift JIBLP
Locked Rail Cant -150mm - Tandem Lift**

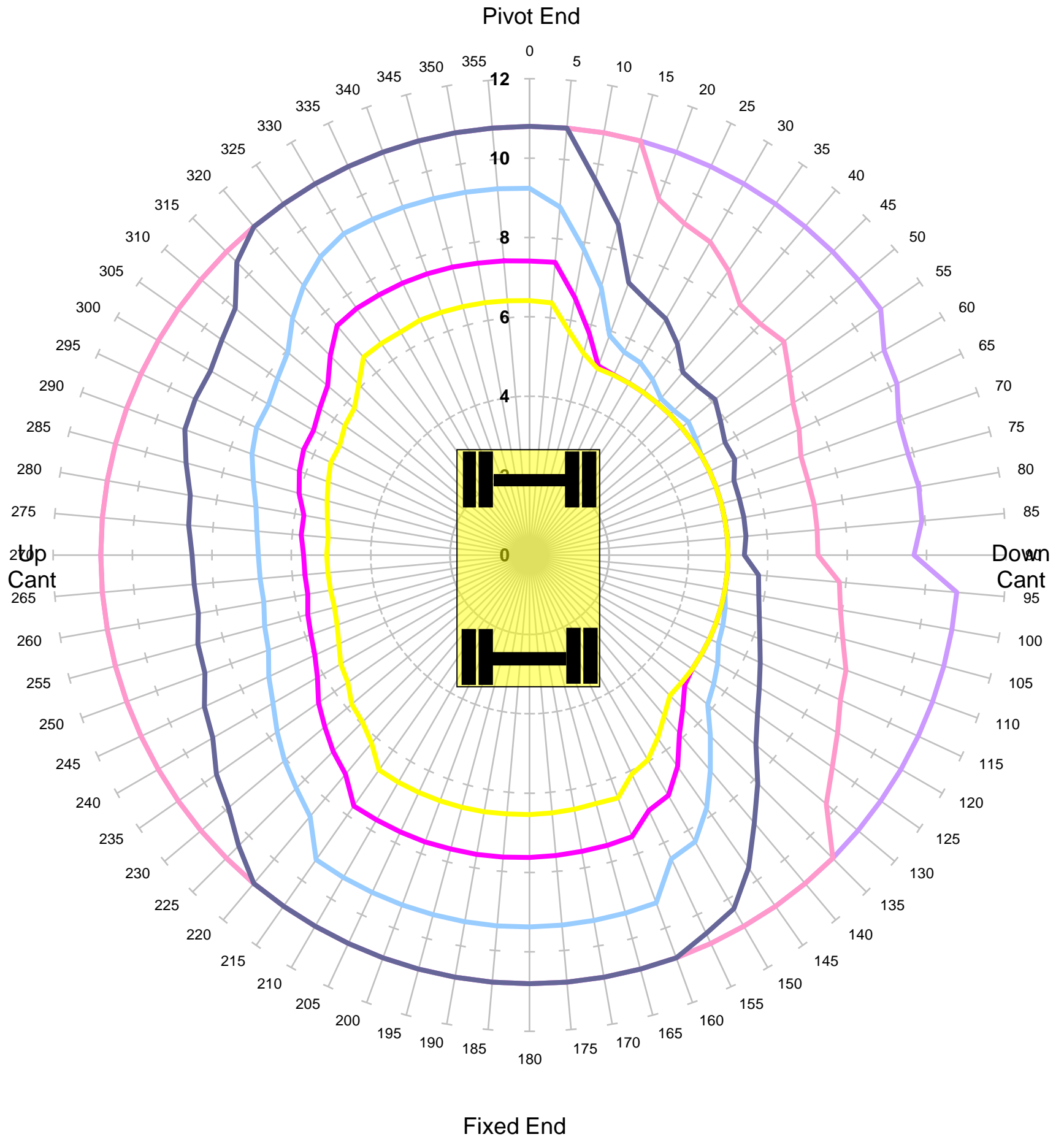

Units in Tonnes

— 0.5
 — 1
 — 1.5
 — 2
 — 2.5
 — 3

MACHINE & MODEL:	Komatsu PW160-11	REFERENCE:	3.00m Jib
SERIAL No:	H65493	DATE OF CHART:	12-Sep-2022
EQUIPMENT:	2.00m + 3.47m + 2.50m	SAFETY FACTOR:	59.0%
COMMENT:			

Komatsu PW160-11

**Max Capacity Contours of Radius(m) Plots 2.5m Dipper 3.0m Jib
Gradient 1 in -25 Height 2m Lift JIBLP
Locked Rail Cant -50mm - Tandem Lift**

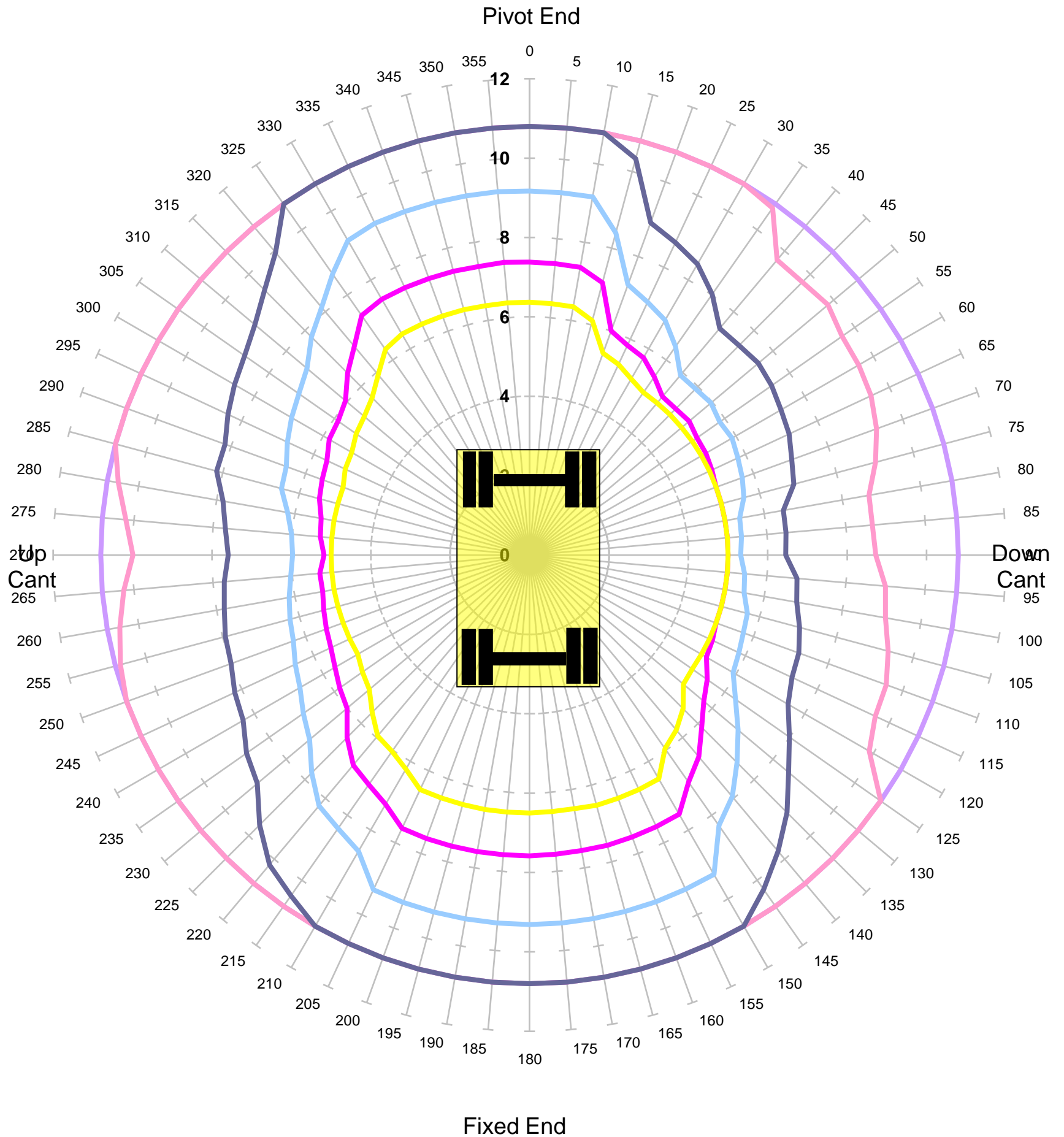

Units in Tonnes

— 0.5
 — 1
 — 1.5
 — 2
 — 2.5
 — 3

MACHINE & MODEL:	Komatsu PW160-11	REFERENCE:	3.00m Jib
SERIAL No:	H65493	DATE OF CHART:	12-Sep-2022
EQUIPMENT:	2.00m + 3.47m + 2.50m	SAFETY FACTOR:	59.0%
COMMENT:			

Komatsu PW160-11

**Max Capacity Contours of Radius(m) Plots 2.5m Dipper 3.0m Jib
Gradient 1 in -25 Height 2m Lift JIBLP
Locked Rail Cant 50mm - Tandem Lift**

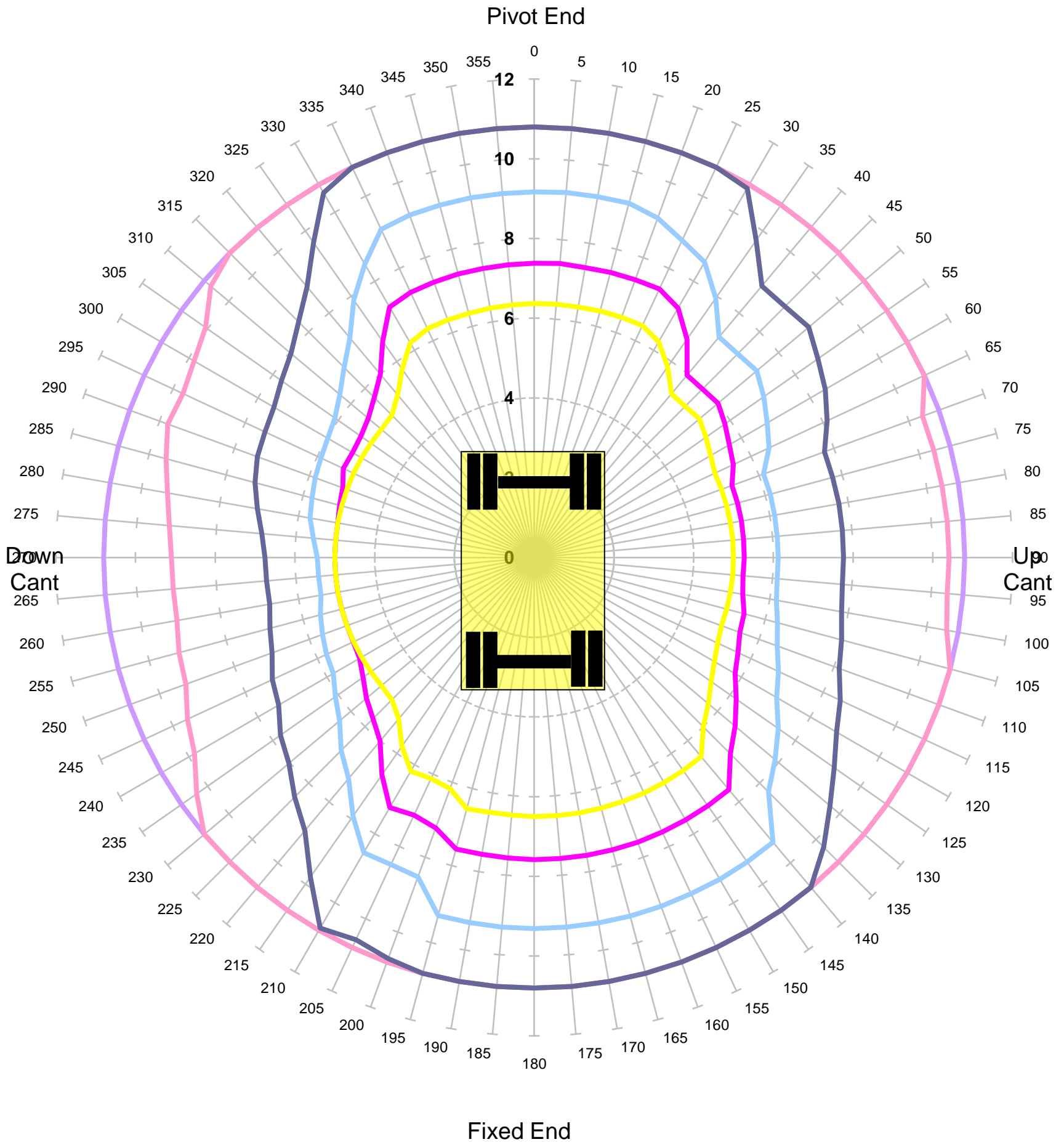

Units in Tonnes

— 0.5 — 1 — 1.5 — 2 — 2.5 — 3

MACHINE & MODEL:	Komatsu PW160-11	REFERENCE:	3.00m Jib
SERIAL No:	H65493	DATE OF CHART:	12-Sep-2022
EQUIPMENT:	2.00m + 3.47m + 2.50m	SAFETY FACTOR:	59.0%
COMMENT:			

Komatsu PW160-11

**Max Capacity Contours of Radius(m) Plots 2.5m Dipper 3.0m Jib
Gradient 1 in -25 Height 2m Lift JIBLP
Locked Rail Cant 150mm - Tandem Lift**

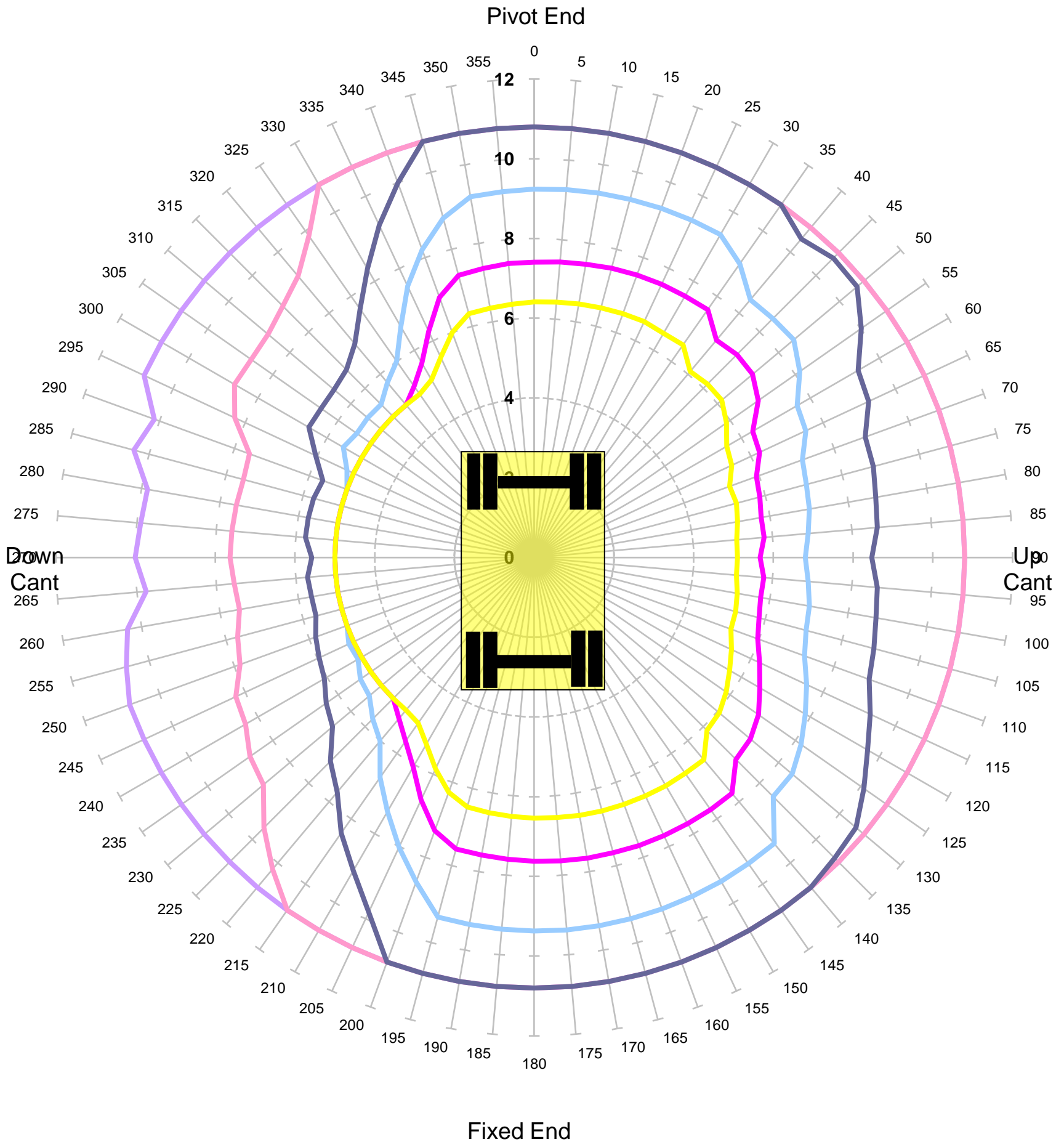

Units in Tonnes

- 0.5
- 1
- 1.5
- 2
- 2.5
- 3

MACHINE & MODEL:	Komatsu PW160-11	REFERENCE:	3.00m Jib
SERIAL No:	H65493	DATE OF CHART:	12-Sep-2022
EQUIPMENT:	2.00m + 3.47m + 2.50m	SAFETY FACTOR:	59.0%
COMMENT:			

Komatsu PW160-11

**Max Capacity Contours of Radius(m) Plots 2.5m Dipper 3.0m Jib
Level Ground Height 2m Lift JIBLP
Unlocked Road - Tandem Lift**

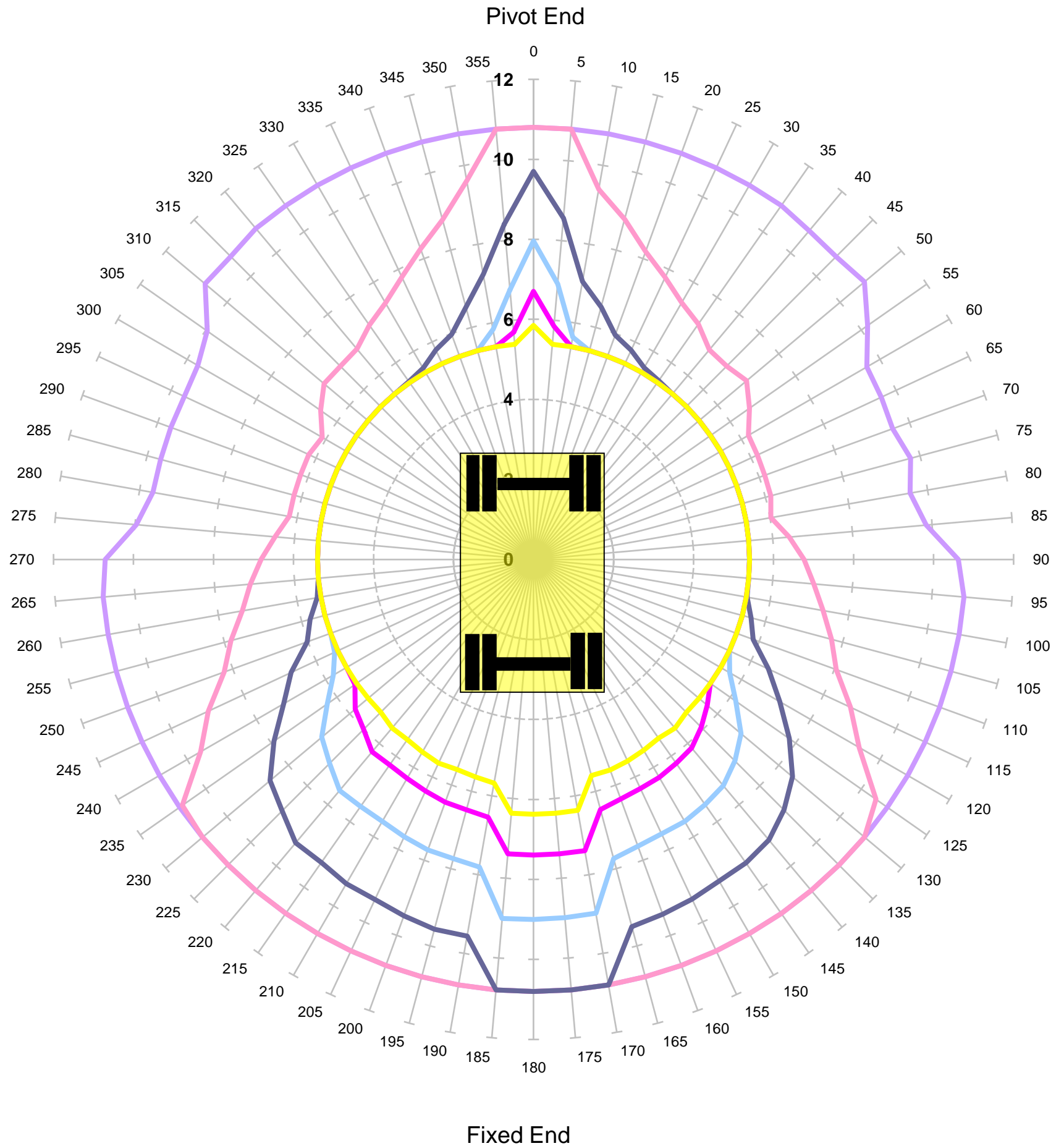

Units in Tonnes

— 0.5
 — 1
 — 1.5
 — 2
 — 2.5
 — 3

MACHINE & MODEL:	Komatsu PW160-11	REFERENCE:	3.00m Jib
SERIAL No:	H65493	DATE OF CHART:	12-Sep-2022
EQUIPMENT:	2.00m + 3.47m + 2.50m	SAFETY FACTOR:	47.0%
COMMENT:			

Komatsu PW160-11

**Max Capacity Contours of Radius(m) Plots 2.5m Dipper 3.0m Jib
Level Ground Height 2m Lift JIBLP
Locked Road - Tandem Lift**

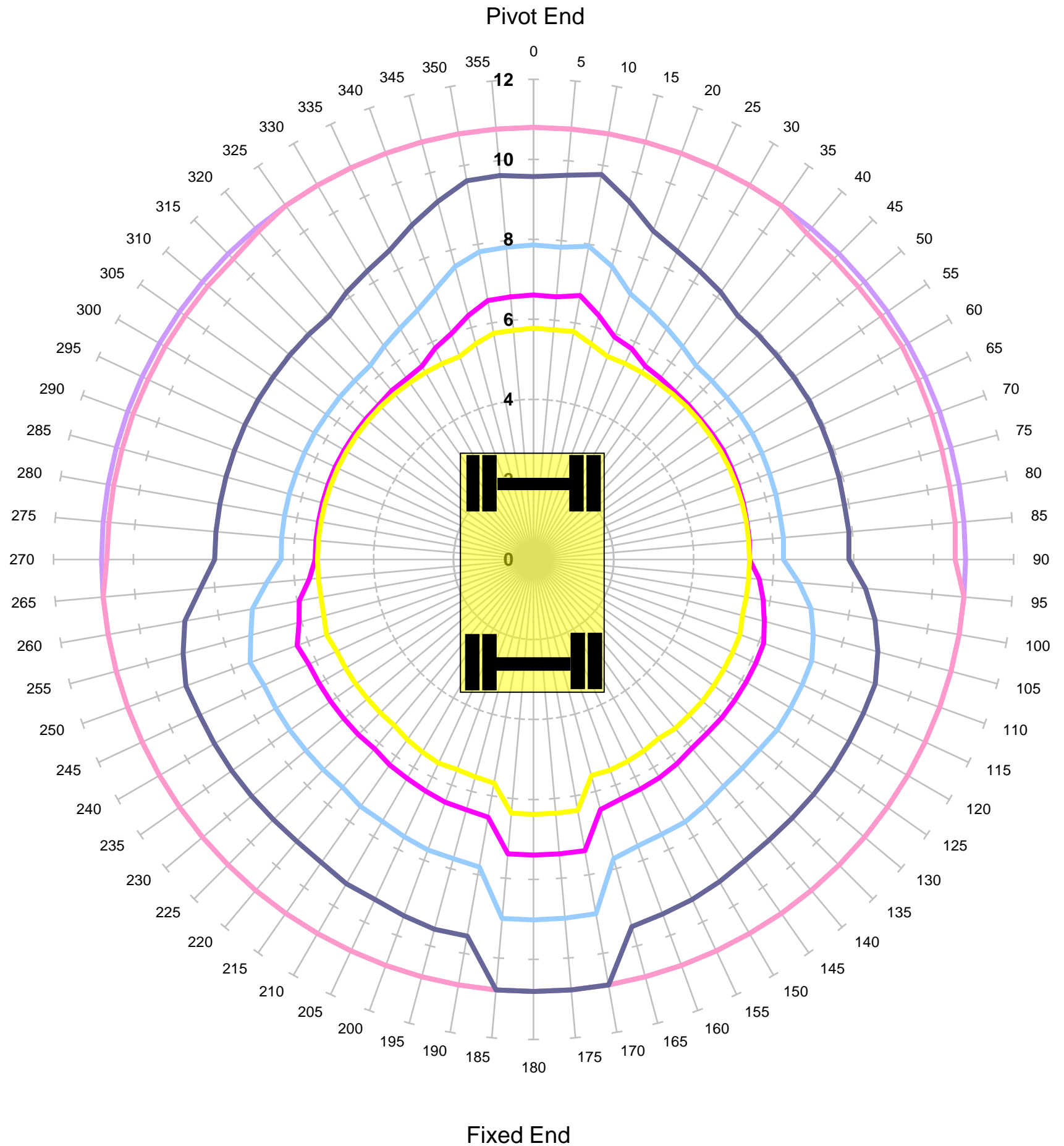

Units in Tonnes

— 0.5
 — 1
 — 1.5
 — 2
 — 2.5
 — 3

MACHINE & MODEL:	Komatsu PW160-11	REFERENCE:	3.00m Jib
SERIAL No:	H65493	DATE OF CHART:	12-Sep-2022
EQUIPMENT:	2.00m + 3.47m + 2.50m	SAFETY FACTOR:	47.0%
COMMENT:			