

Komatsu PW160-7
Max Capacity Contours of Radius(m) Plots 2.1m Dipper
Gradient 1 in -25 Height 2m Lift BP
Unlocked Rail Cant -150mm

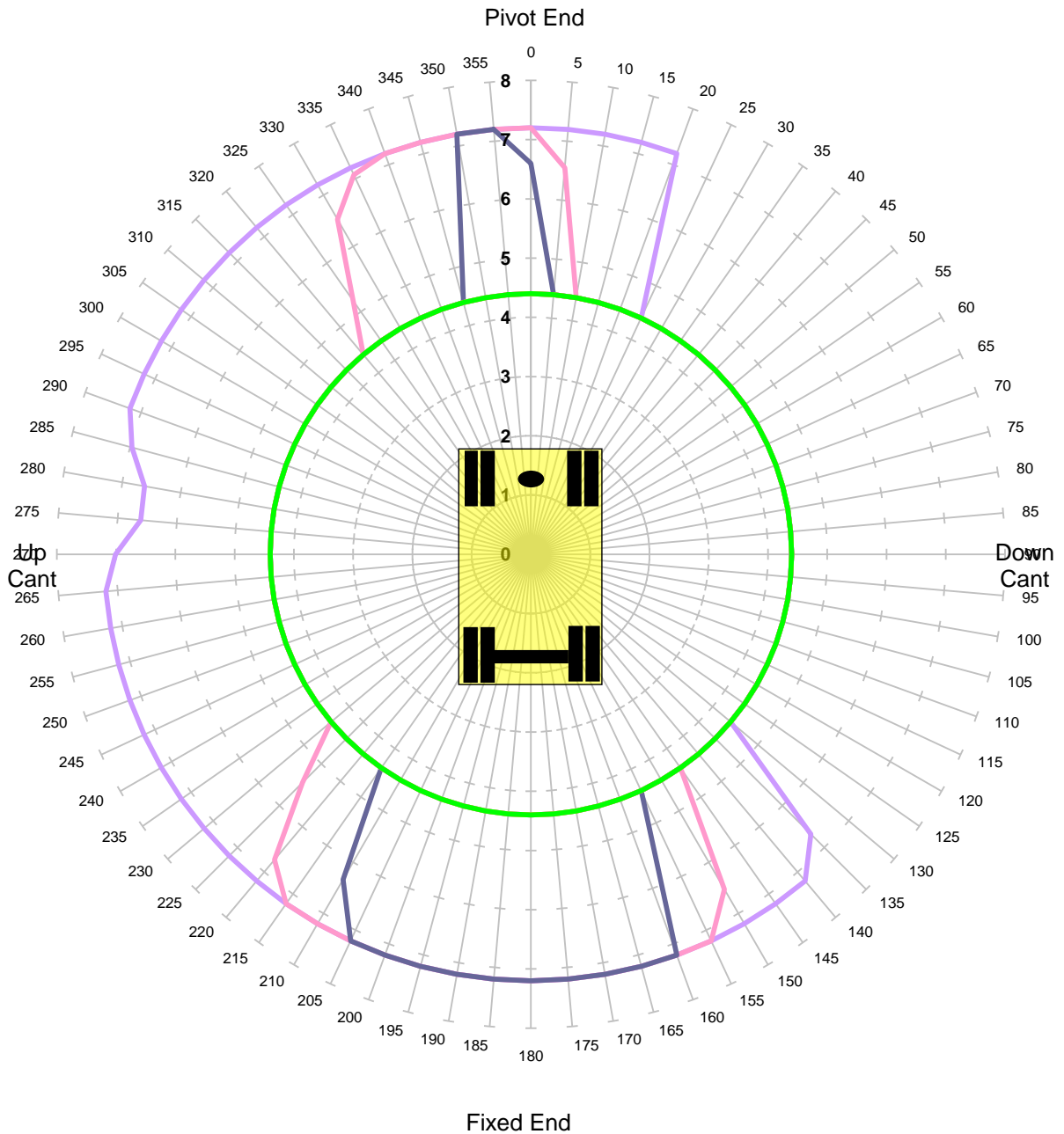

MACHINE & MODEL:	Komatsu PW160-7	REFERENCE:	REXQUOTE
SERIAL No:	2345	DATE OF CHART:	24-Feb-2022
EQUIPMENT:	5.15m+2.1m	SAFETY FACTOR:	63.0%
COMMENT:			

Komatsu PW160-7
Max Capacity Contours of Radius(m) Plots 2.1m Dipper
Gradient 1 in -25 Height 2m Lift BP
Unlocked Rail Cant -50mm

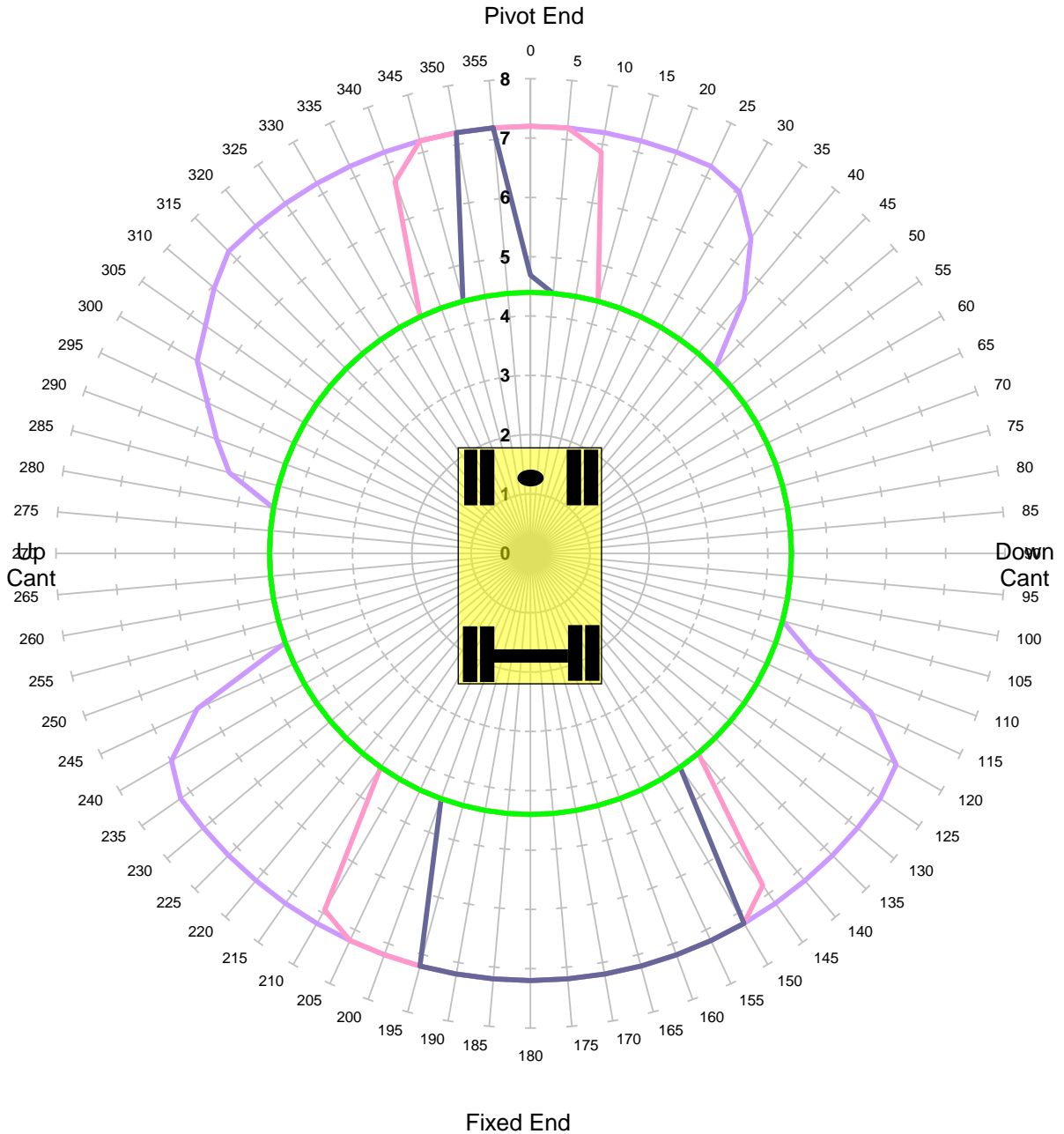

Units in Tonnes

- 1
- 2
- 3
- 4
- 5
- 6
- 7

MACHINE & MODEL:	Komatsu PW160-7	REFERENCE:	REXQUOTE
SERIAL No:	2345	DATE OF CHART:	24-Feb-2022
EQUIPMENT:	5.15m+2.1m	SAFETY FACTOR:	63.0%
COMMENT:			

Komatsu PW160-7
Max Capacity Contours of Radius(m) Plots 2.1m Dipper
Gradient 1 in -25 Height 2m Lift BP
Unlocked Rail Cant 50mm

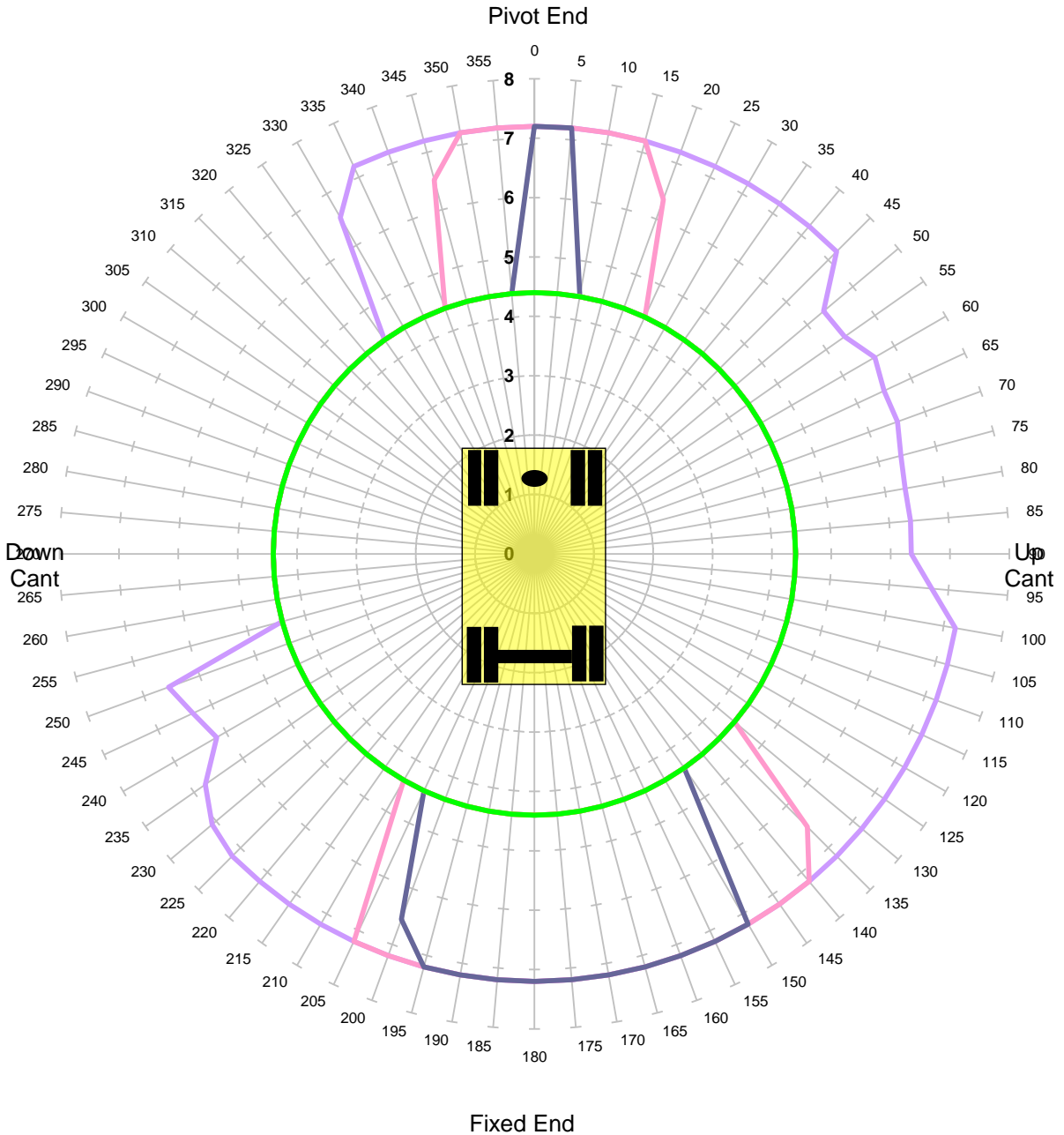

Units in Tonnes

- 1
- 2
- 3
- 4
- 5
- 6
- 7

MACHINE & MODEL:	Komatsu PW160-7	REFERENCE:	REXQUOTE
SERIAL No:	2345	DATE OF CHART:	24-Feb-2022
EQUIPMENT:	5.15m+2.1m	SAFETY FACTOR:	63.0%
COMMENT:			

Komatsu PW160-7
Max Capacity Contours of Radius(m) Plots 2.1m Dipper
Gradient 1 in -25 Height 2m Lift BP
Unlocked Rail Cant 150mm

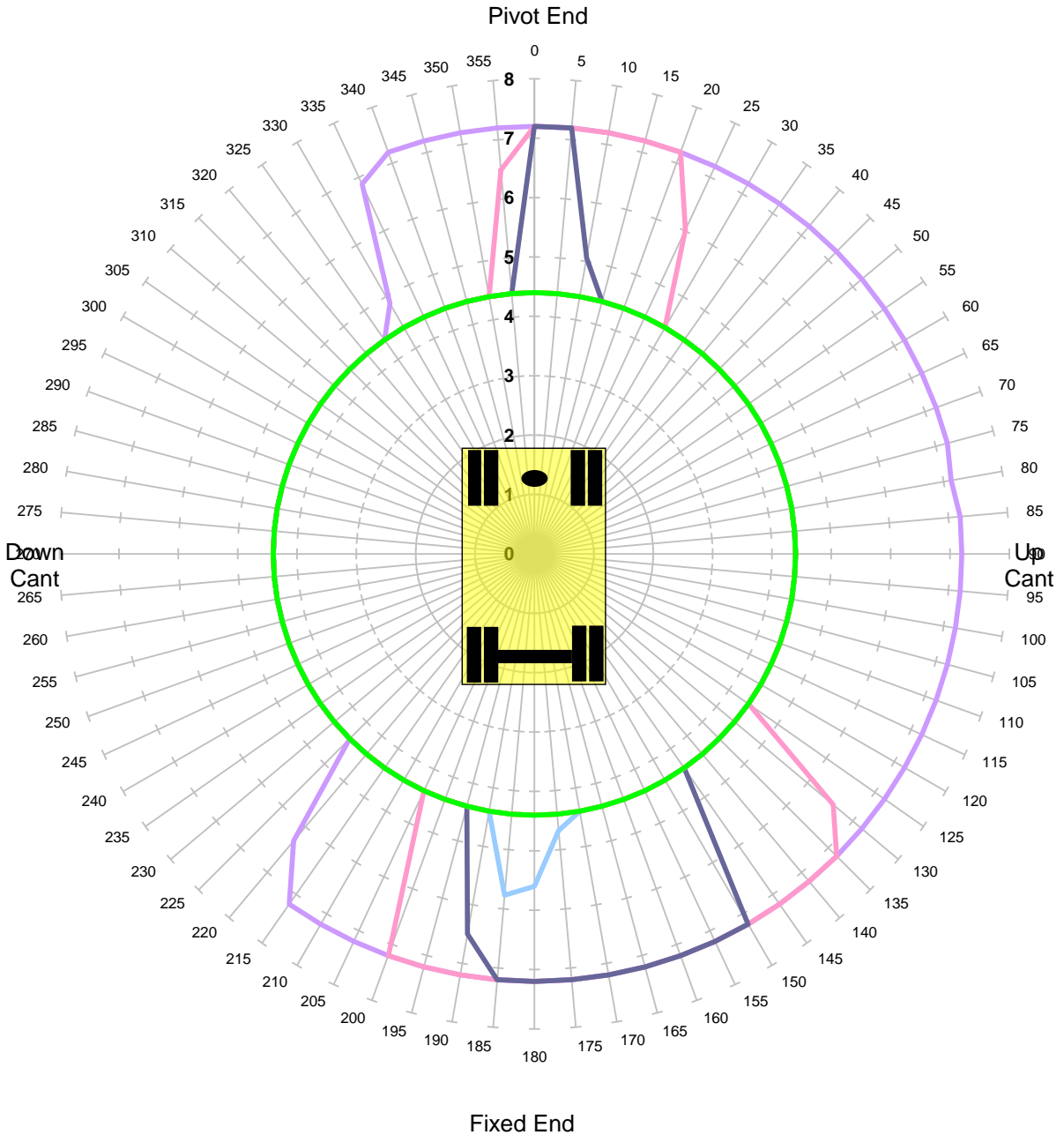

Units in Tonnes

- 1
- 2
- 3
- 4
- 5
- 6
- 7

MACHINE & MODEL:	Komatsu PW160-7	REFERENCE:	REXQUOTE
SERIAL No:	2345	DATE OF CHART:	24-Feb-2022
EQUIPMENT:	5.15m+2.1m	SAFETY FACTOR:	63.0%
COMMENT:			

Komatsu PW160-7
Max Capacity Contours of Radius(m) Plots 2.1m Dipper
Gradient 1 in -25 Height 2m Lift BP
Locked Rail Cant -150mm

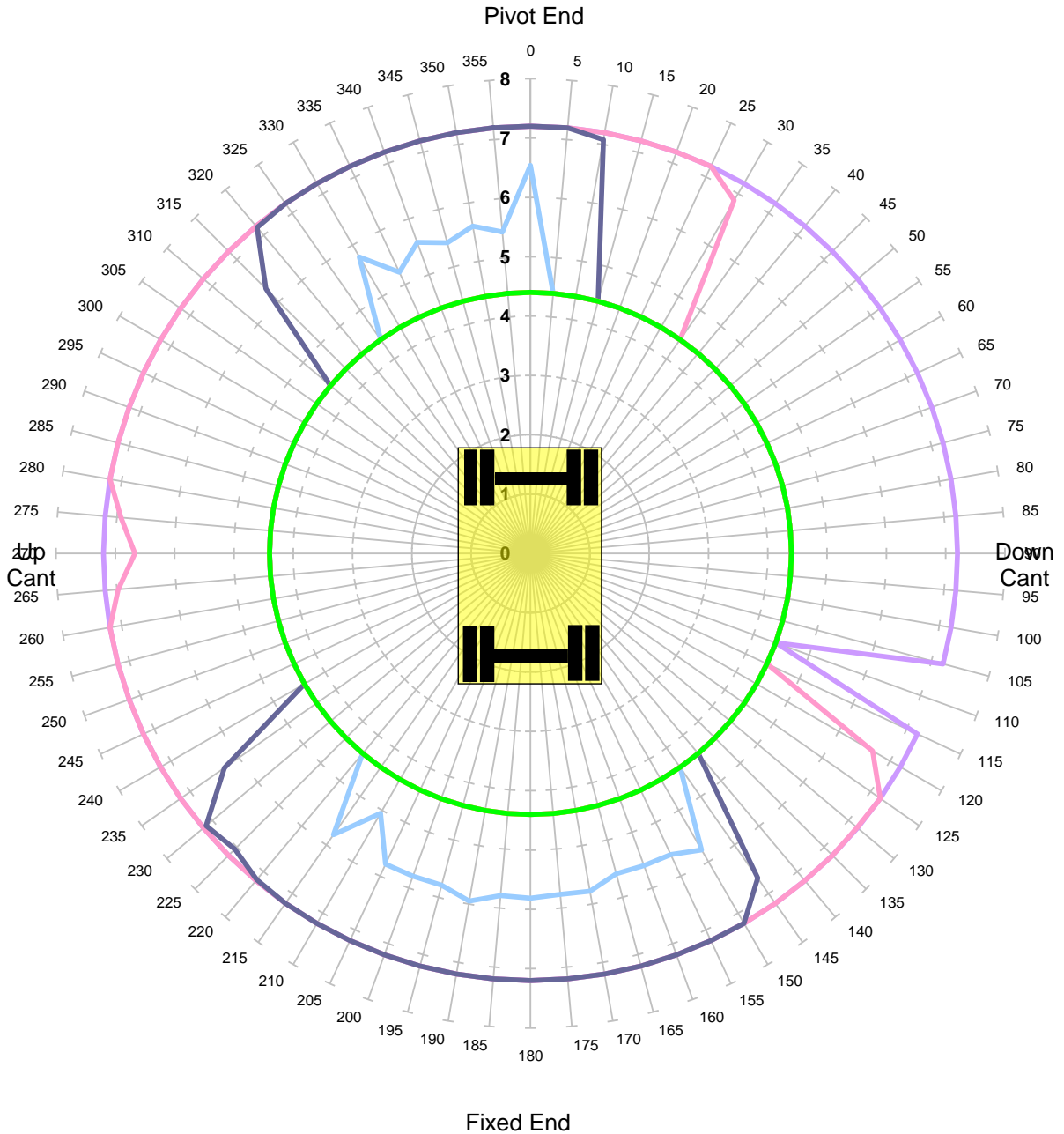

Units in Tonnes

- 1
- 2
- 3
- 4
- 5
- 6
- 7

MACHINE & MODEL:	Komatsu PW160-7	REFERENCE:	REXQUOTE
SERIAL No:	2345	DATE OF CHART:	24-Feb-2022
EQUIPMENT:	5.15m+2.1m	SAFETY FACTOR:	85.0%
COMMENT:			

Komatsu PW160-7
Max Capacity Contours of Radius(m) Plots 2.1m Dipper
Gradient 1 in -25 Height 2m Lift BP
Locked Rail Cant -50mm

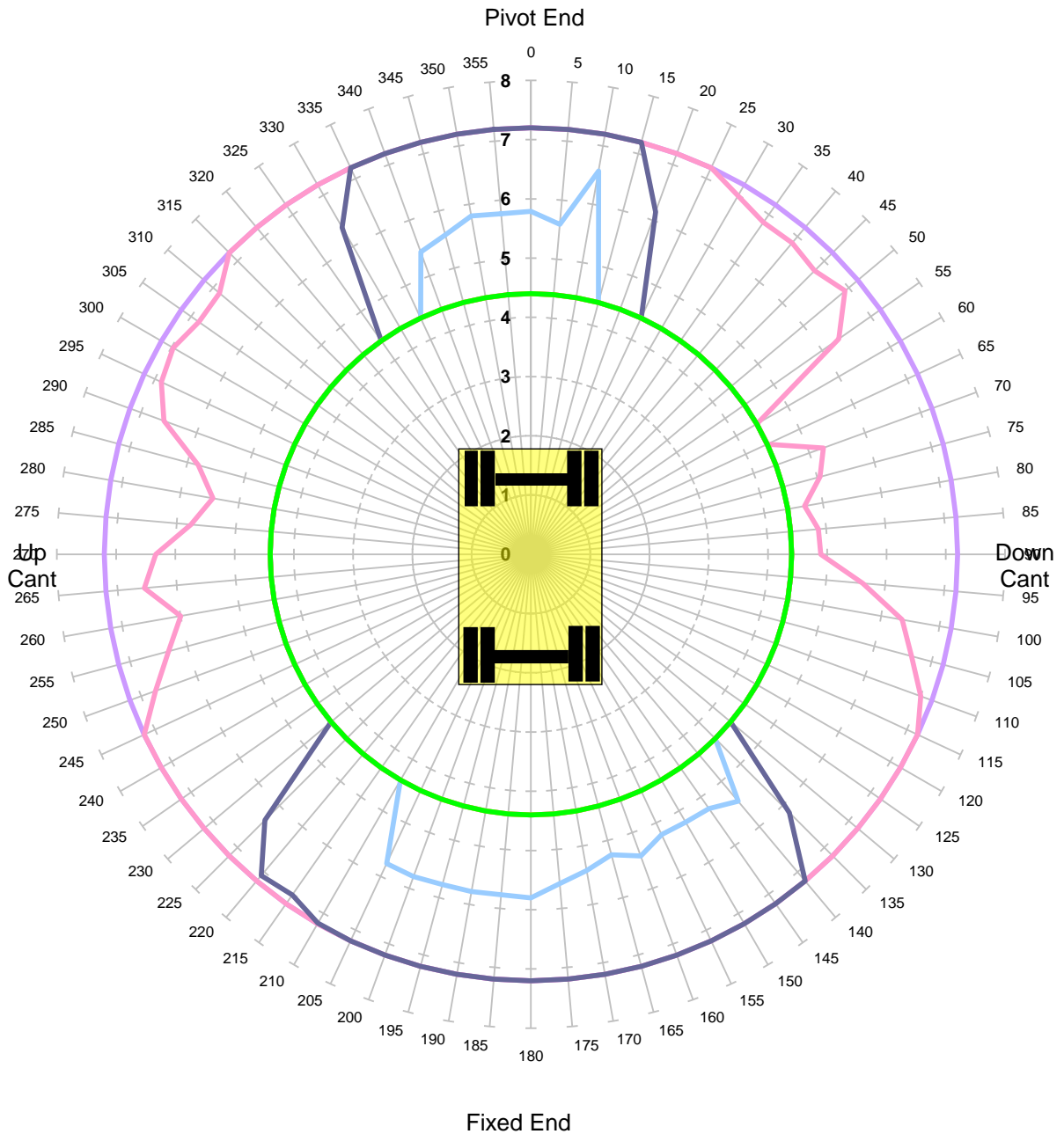

Units in Tonnes

- 1
- 2
- 3
- 4
- 5
- 6
- 7

MACHINE & MODEL:	Komatsu PW160-7	REFERENCE:	REXQUOTE
SERIAL No:	2345	DATE OF CHART:	24-Feb-2022
EQUIPMENT:	5.15m+2.1m	SAFETY FACTOR:	85.0%
COMMENT:			

Komatsu PW160-7
Max Capacity Contours of Radius(m) Plots 2.1m Dipper
Gradient 1 in -25 Height 2m Lift BP
Locked Rail Cant 50mm

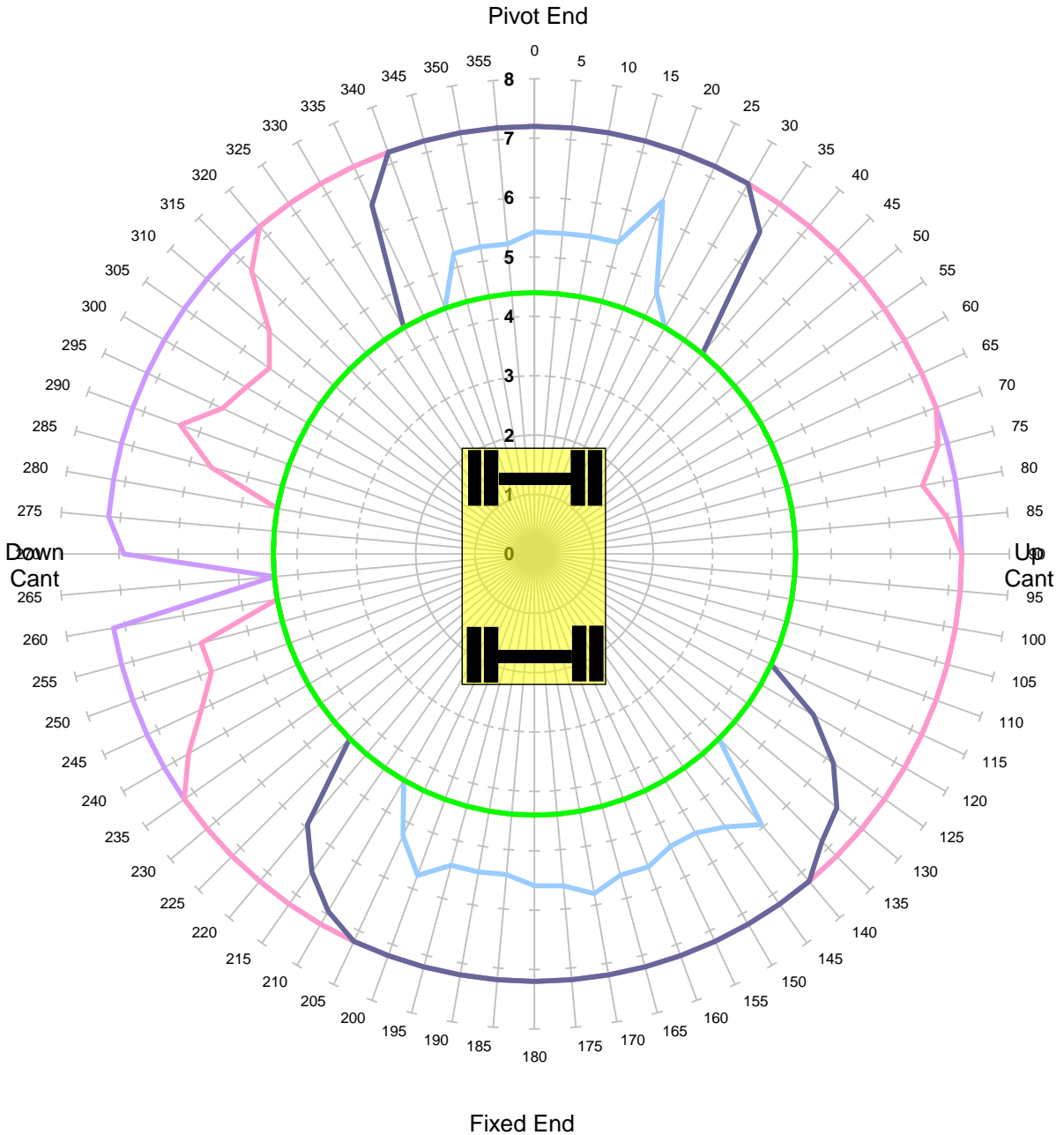

Units in Tonnes

- 1
- 2
- 3
- 4
- 5
- 6
- 7

MACHINE & MODEL:	Komatsu PW160-7	REFERENCE:	REXQUOTE
SERIAL No:	2345	DATE OF CHART:	24-Feb-2022
EQUIPMENT:	5.15m+2.1m	SAFETY FACTOR:	85.0%
COMMENT:			

Komatsu PW160-7
Max Capacity Contours of Radius(m) Plots 2.1m Dipper
Gradient 1 in -25 Height 2m Lift BP
Locked Rail Cant 150mm

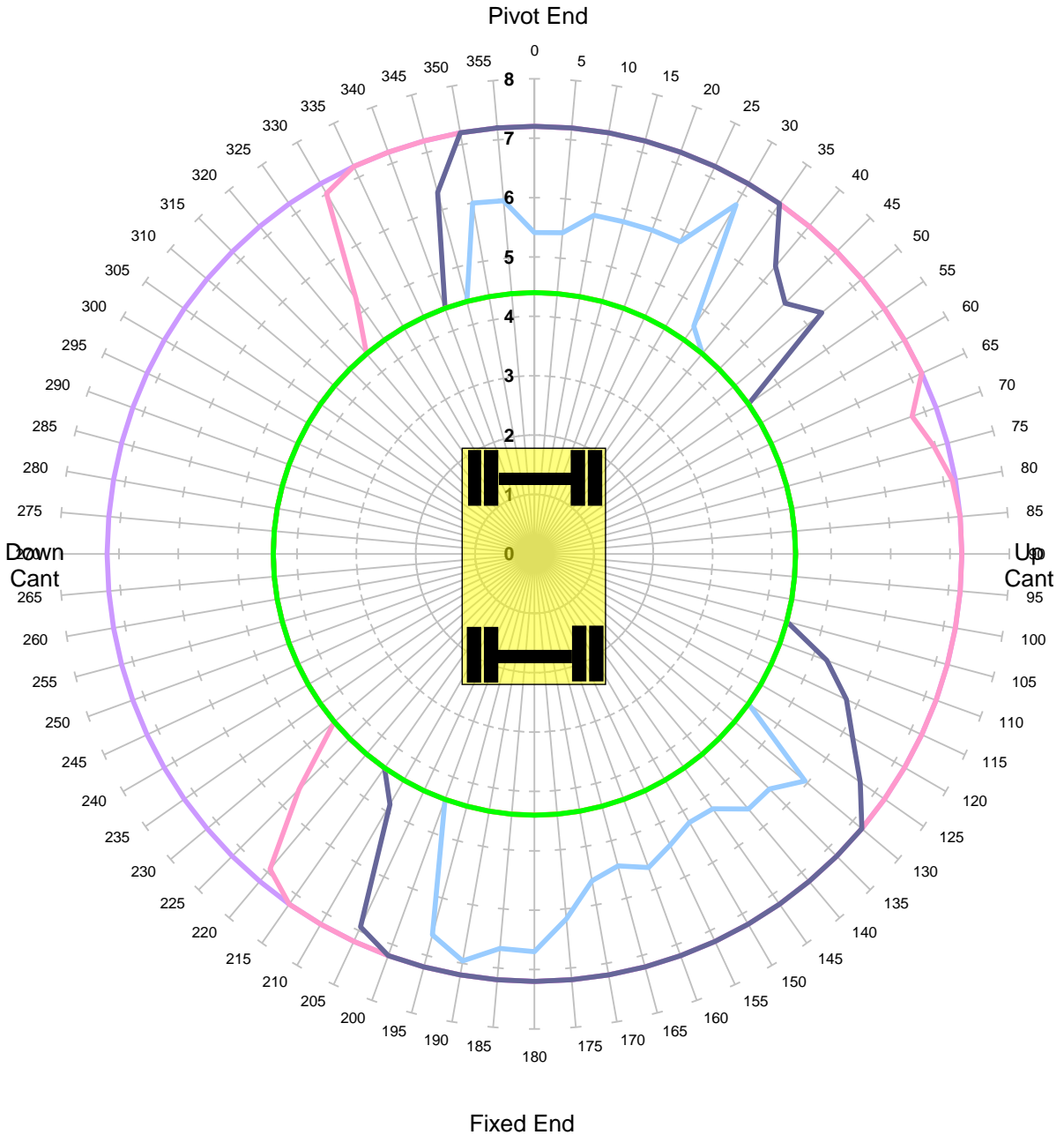

Units in Tonnes

- 1
- 2
- 3
- 4
- 5
- 6
- 7

MACHINE & MODEL:	Komatsu PW160-7	REFERENCE:	REXQUOTE
SERIAL No:	2345	DATE OF CHART:	24-Feb-2022
EQUIPMENT:	5.15m+2.1m	SAFETY FACTOR:	85.0%
COMMENT:			

Komatsu PW160-7
Max Capacity Contours of Radius(m) Plots 2.1m Dipper
Level Ground Height 2m Lift BP
Unlocked Road

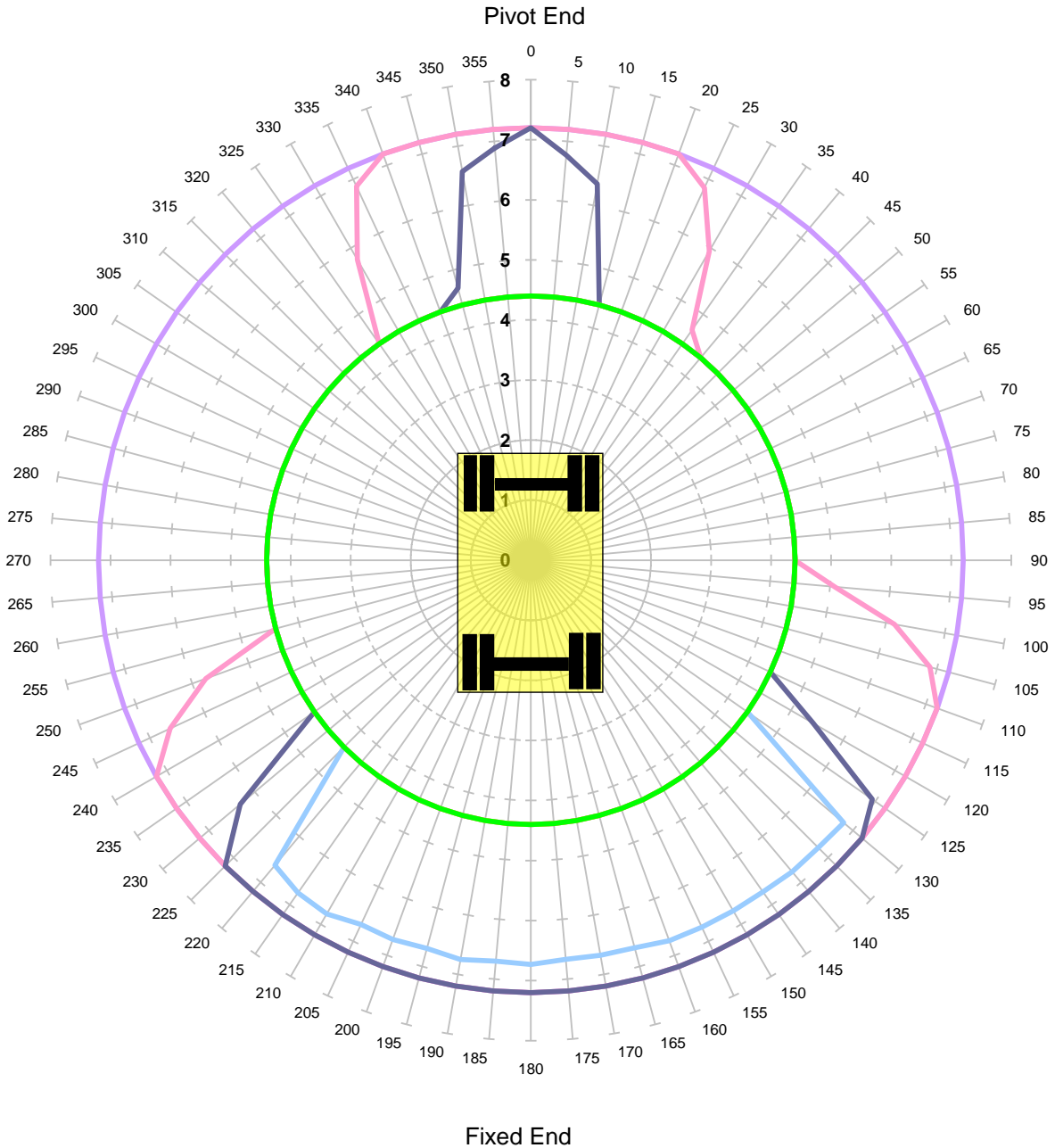

Units in Tonnes

- 1
- 2
- 3
- 4
- 5
- 6
- 7

MACHINE & MODEL:	Komatsu PW160-7	REFERENCE:	REXQUOTE
SERIAL No:	2345	DATE OF CHART:	24-Feb-2022
EQUIPMENT:	5.15m+2.1m	SAFETY FACTOR:	67.0%
COMMENT:			

Komatsu PW160-7
Max Capacity Contours of Radius(m) Plots 2.1m Dipper
Level Ground Height 2m Lift BP
Locked Road

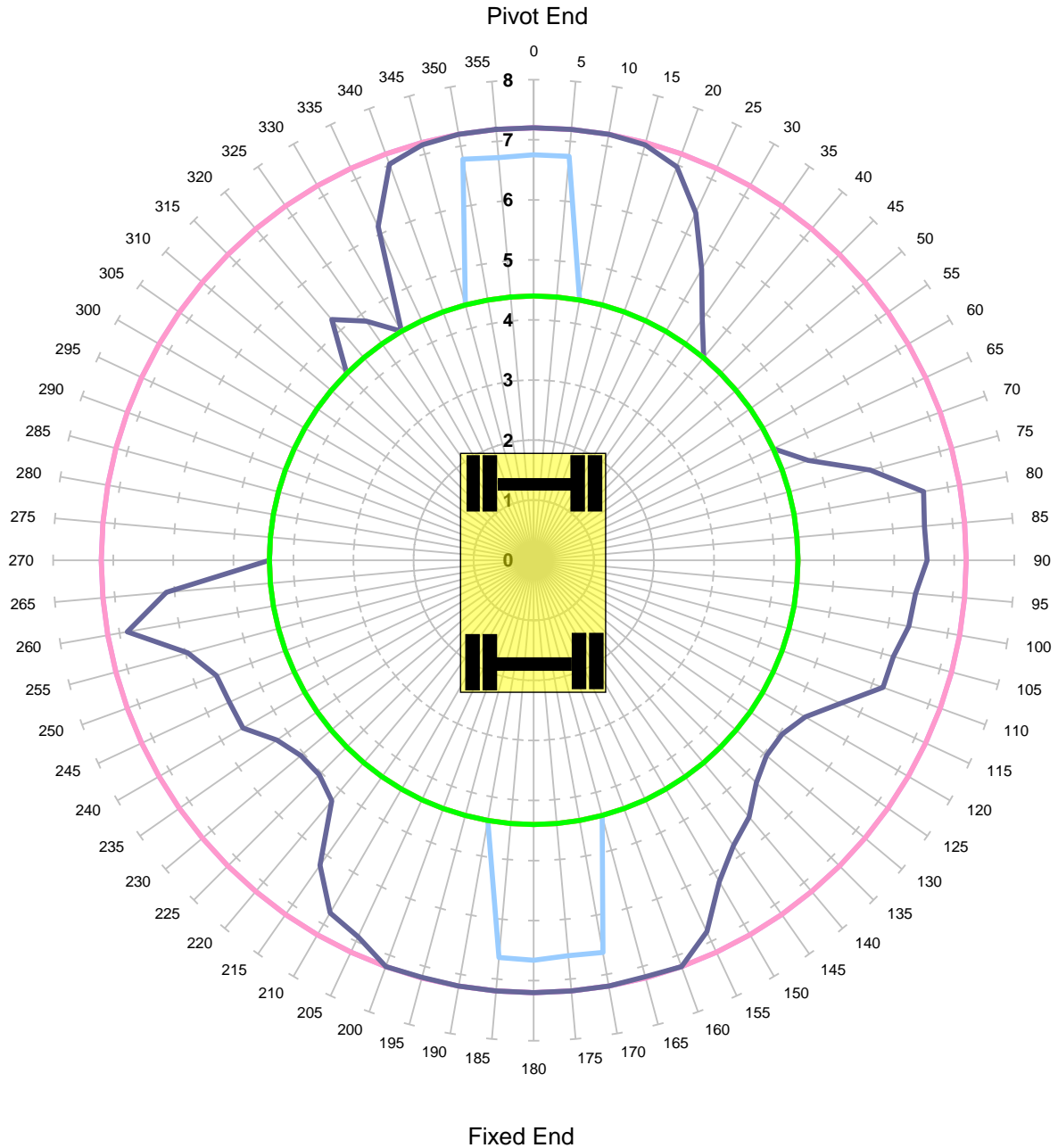

Units in Tonnes

- 1
- 2
- 3
- 4
- 5
- 6
- 7

MACHINE & MODEL:	Komatsu PW160-7	REFERENCE:	REXQUOTE
SERIAL No:	2345	DATE OF CHART:	24-Feb-2022
EQUIPMENT:	5.15m+2.1m	SAFETY FACTOR:	67.0%
COMMENT:			

Komatsu PW160-7
Max Capacity Contours of Radius(m) Plots 2.1m Dipper
Gradient 1 in -25 Height 2m Lift BP
Unlocked Rail Cant -150mm - Tandem Lift

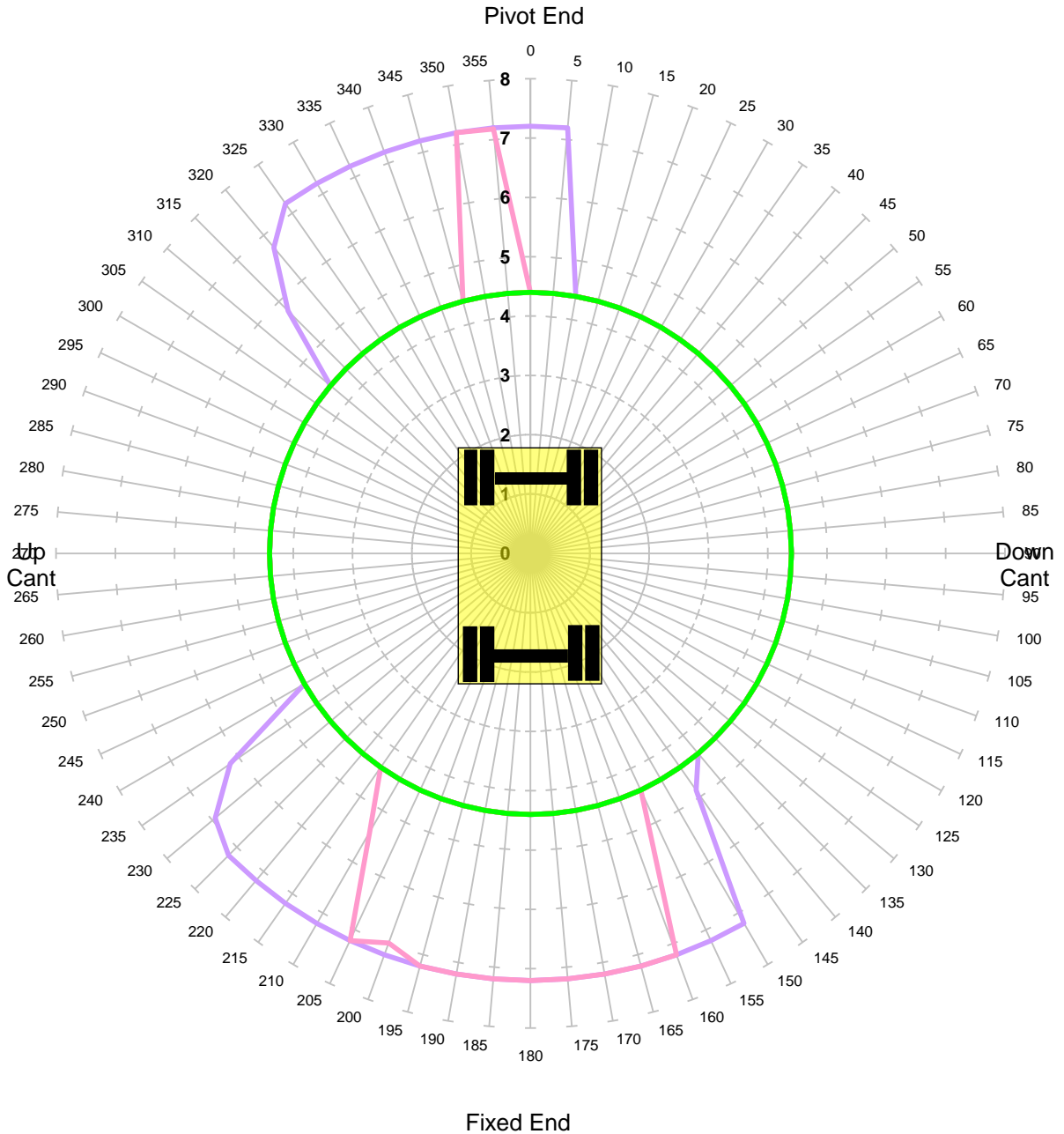

MACHINE & MODEL:	Komatsu PW160-7	REFERENCE:	REXQUOTE
SERIAL No:	2345	DATE OF CHART:	24-Feb-2022
EQUIPMENT:	5.15m+2.1m	SAFETY FACTOR:	39.0%
COMMENT:			

Komatsu PW160-7
Max Capacity Contours of Radius(m) Plots 2.1m Dipper
Gradient 1 in -25 Height 2m Lift BP
Unlocked Rail Cant -50mm - Tandem Lift

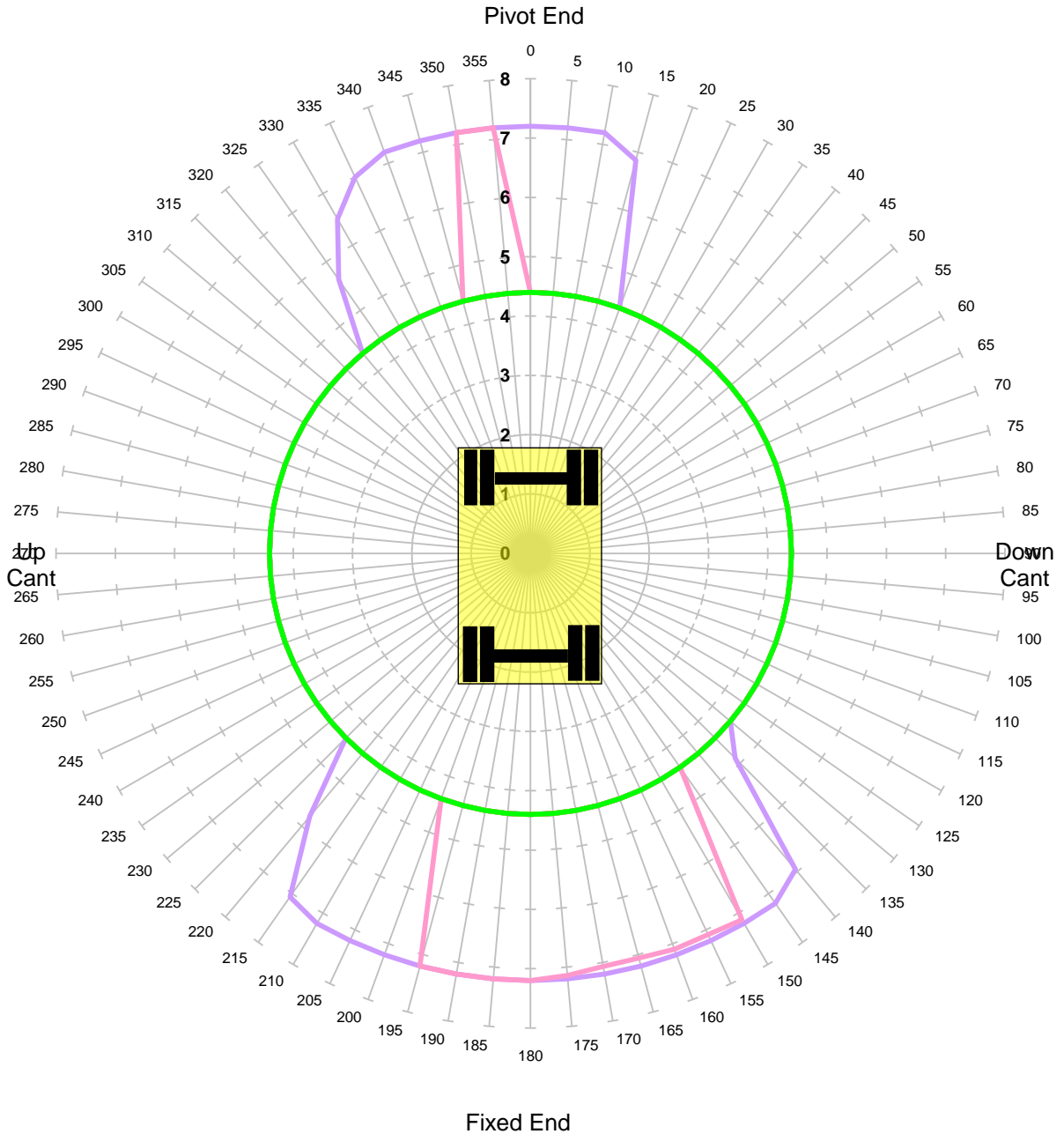

Units in Tonnes

- 1
- 2
- 3
- 4
- 5
- 6
- 7

MACHINE & MODEL:	Komatsu PW160-7	REFERENCE:	REXQUOTE
SERIAL No:	2345	DATE OF CHART:	24-Feb-2022
EQUIPMENT:	5.15m+2.1m	SAFETY FACTOR:	39.0%
COMMENT:			

Komatsu PW160-7
Max Capacity Contours of Radius(m) Plots 2.1m Dipper
Gradient 1 in -25 Height 2m Lift BP
Unlocked Rail Cant 50mm - Tandem Lift

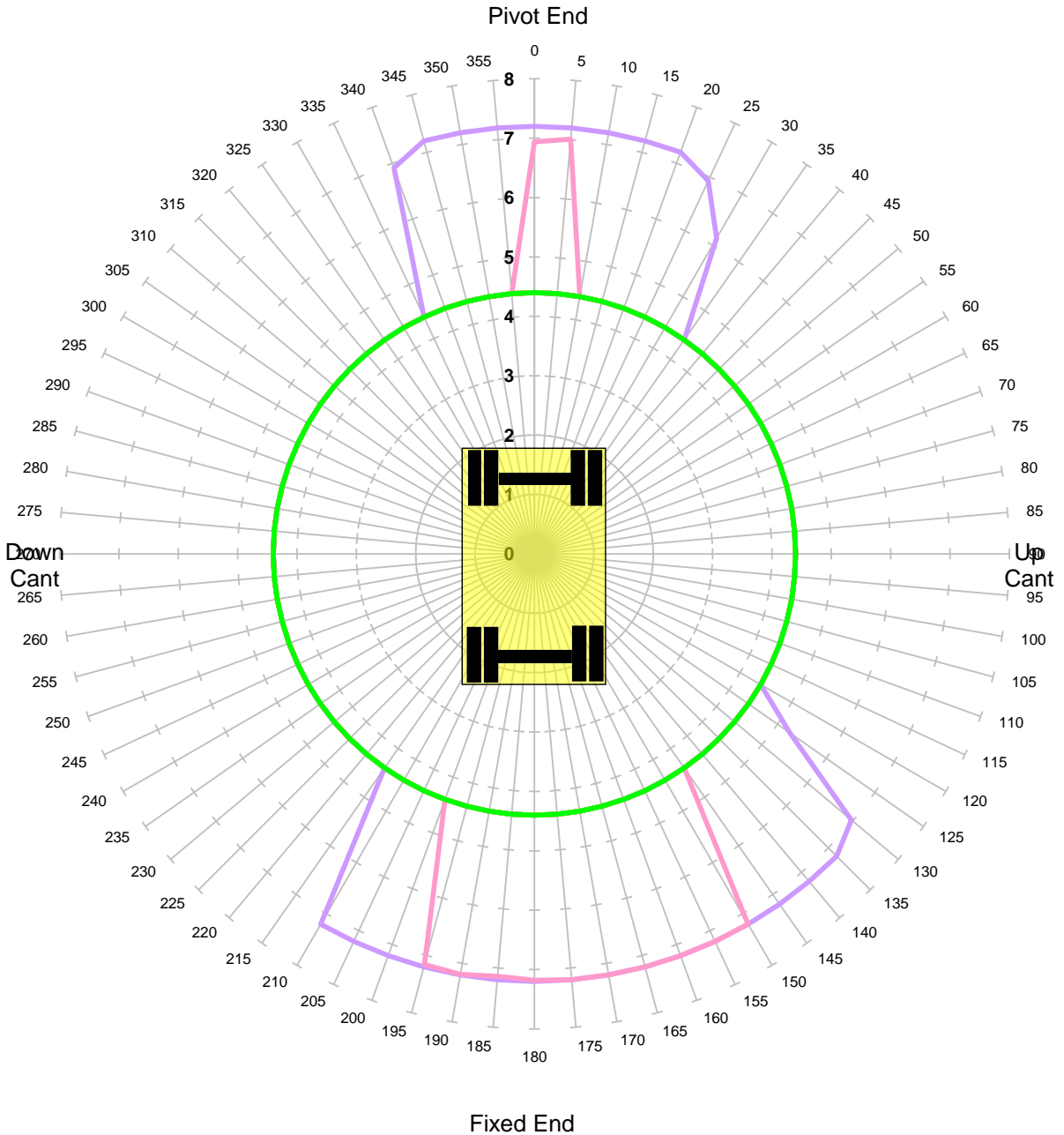

Units in Tonnes

- 1
- 2
- 3
- 4
- 5
- 6
- 7

MACHINE & MODEL:	Komatsu PW160-7	REFERENCE:	REXQUOTE
SERIAL No:	2345	DATE OF CHART:	24-Feb-2022
EQUIPMENT:	5.15m+2.1m	SAFETY FACTOR:	39.0%
COMMENT:			

Komatsu PW160-7
Max Capacity Contours of Radius(m) Plots 2.1m Dipper
Gradient 1 in -25 Height 2m Lift BP
Unlocked Rail Cant 150mm - Tandem Lift

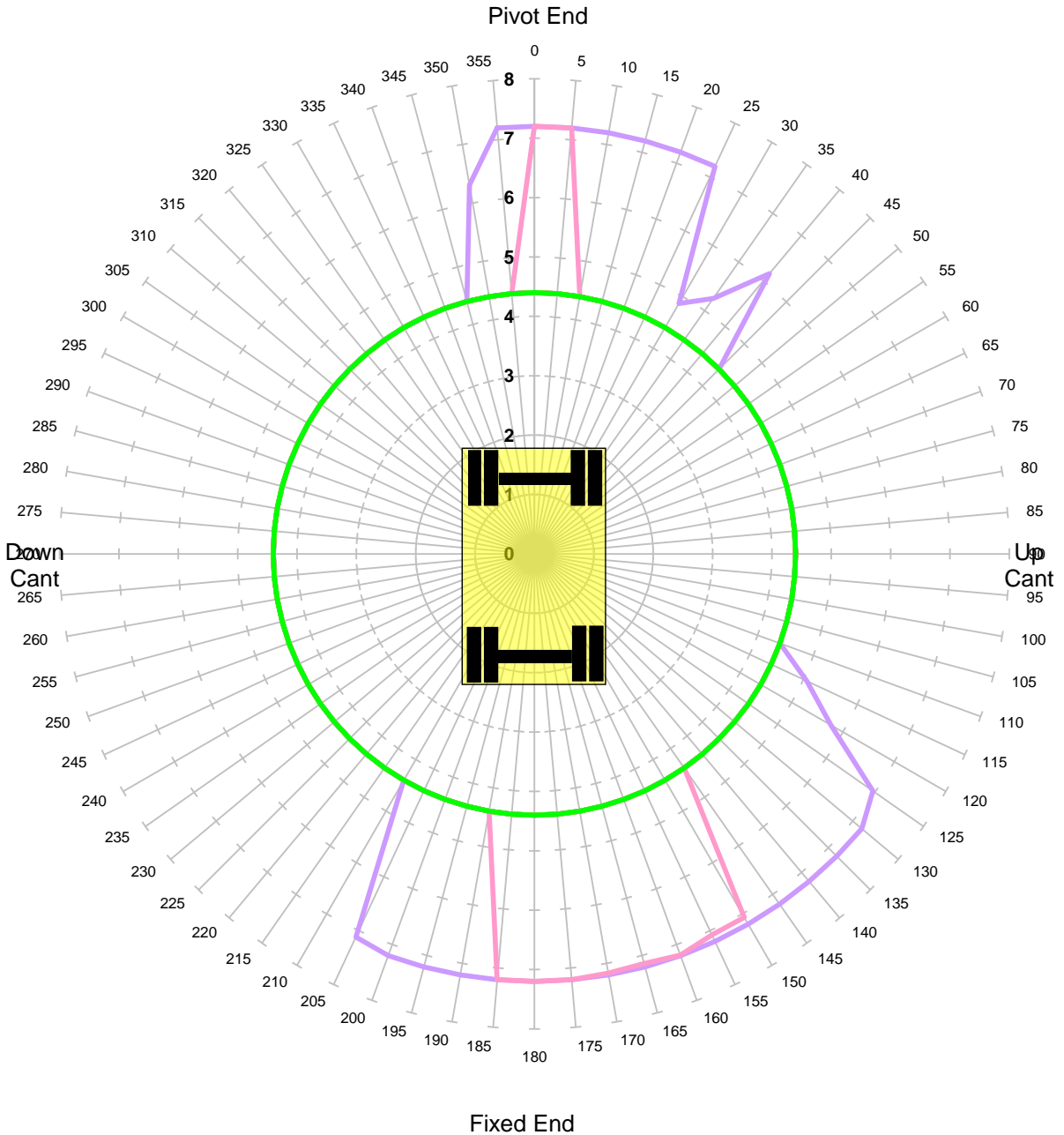

Units in Tonnes

- 1
- 2
- 3
- 4
- 5
- 6
- 7

MACHINE & MODEL:	Komatsu PW160-7	REFERENCE:	REXQUOTE
SERIAL No:	2345	DATE OF CHART:	24-Feb-2022
EQUIPMENT:	5.15m+2.1m	SAFETY FACTOR:	39.0%
COMMENT:			

Komatsu PW160-7
Max Capacity Contours of Radius(m) Plots 2.1m Dipper
Gradient 1 in -25 Height 2m Lift BP
Locked Rail Cant -150mm - Tandem Lift

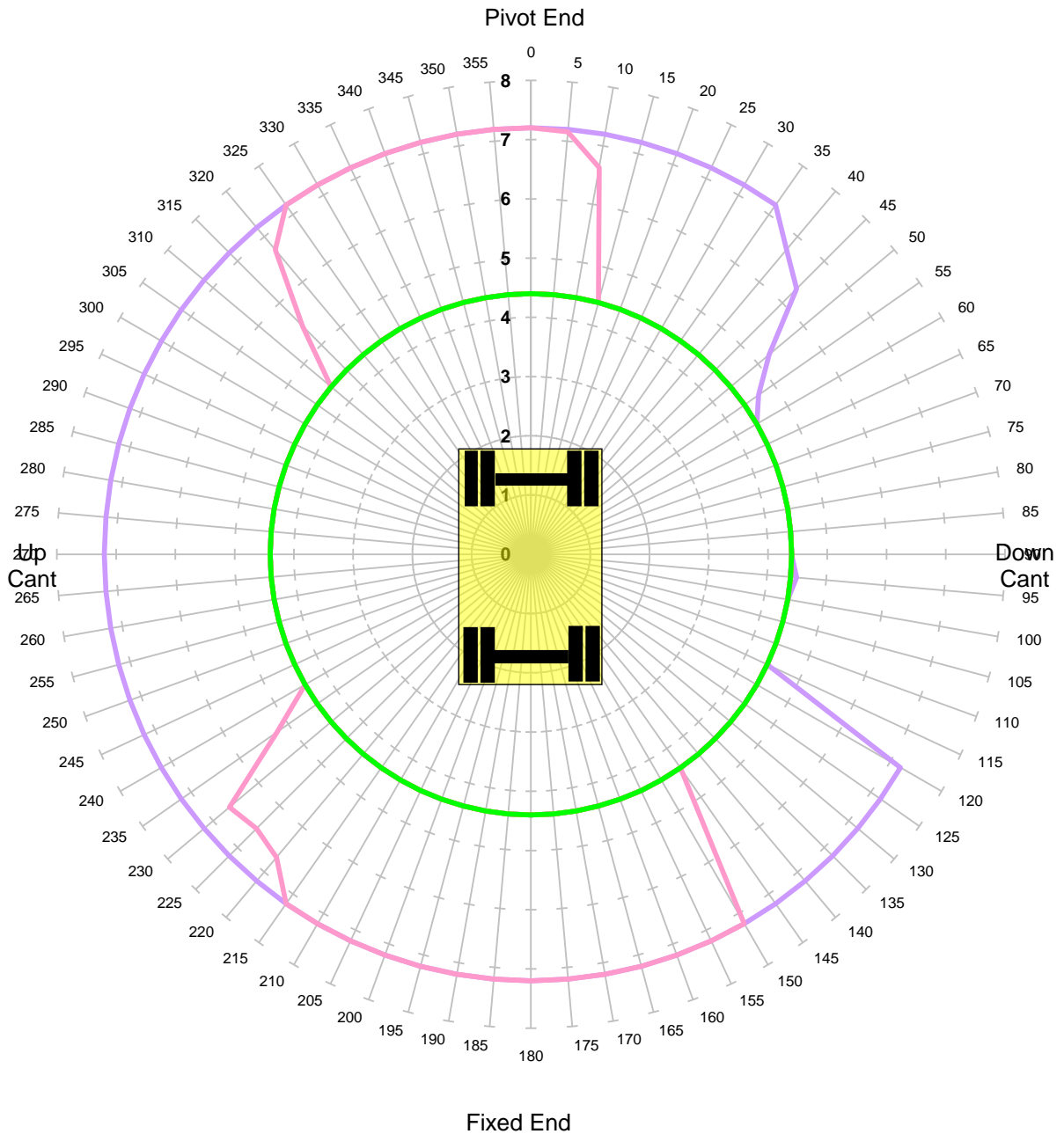

Units in Tonnes

- 1
- 2
- 3
- 4
- 5
- 6
- 7

MACHINE & MODEL:	Komatsu PW160-7	REFERENCE:	REXQUOTE
SERIAL No:	2345	DATE OF CHART:	24-Feb-2022
EQUIPMENT:	5.15m+2.1m	SAFETY FACTOR:	53.0%
COMMENT:			

Komatsu PW160-7
Max Capacity Contours of Radius(m) Plots 2.1m Dipper
Gradient 1 in -25 Height 2m Lift BP
Locked Rail Cant -50mm - Tandem Lift

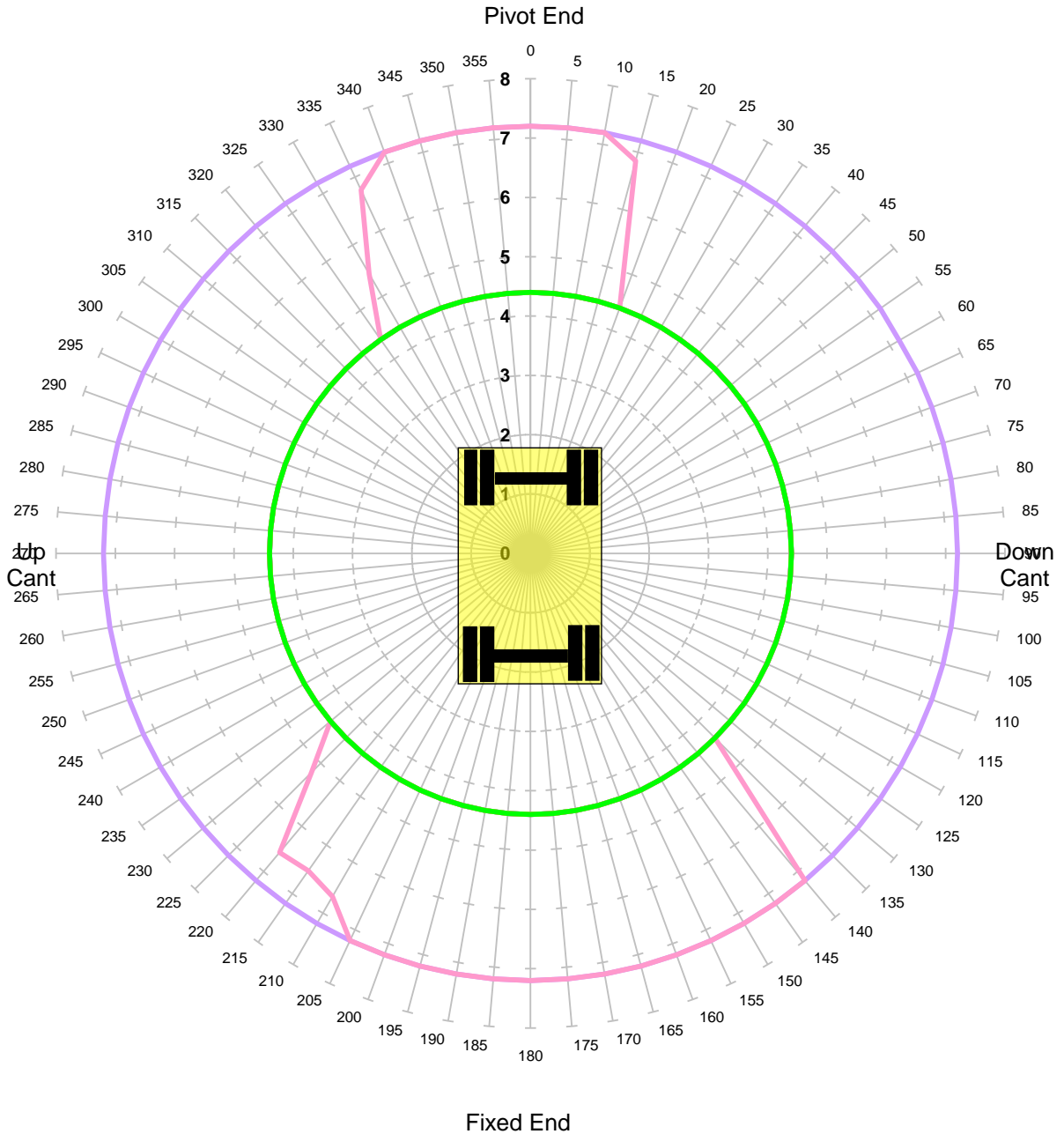

MACHINE & MODEL:	Komatsu PW160-7	REFERENCE:	REXQUOTE
SERIAL No:	2345	DATE OF CHART:	24-Feb-2022
EQUIPMENT:	5.15m+2.1m	SAFETY FACTOR:	53.0%
COMMENT:			

Komatsu PW160-7
Max Capacity Contours of Radius(m) Plots 2.1m Dipper
Gradient 1 in -25 Height 2m Lift BP
Locked Rail Cant 50mm - Tandem Lift

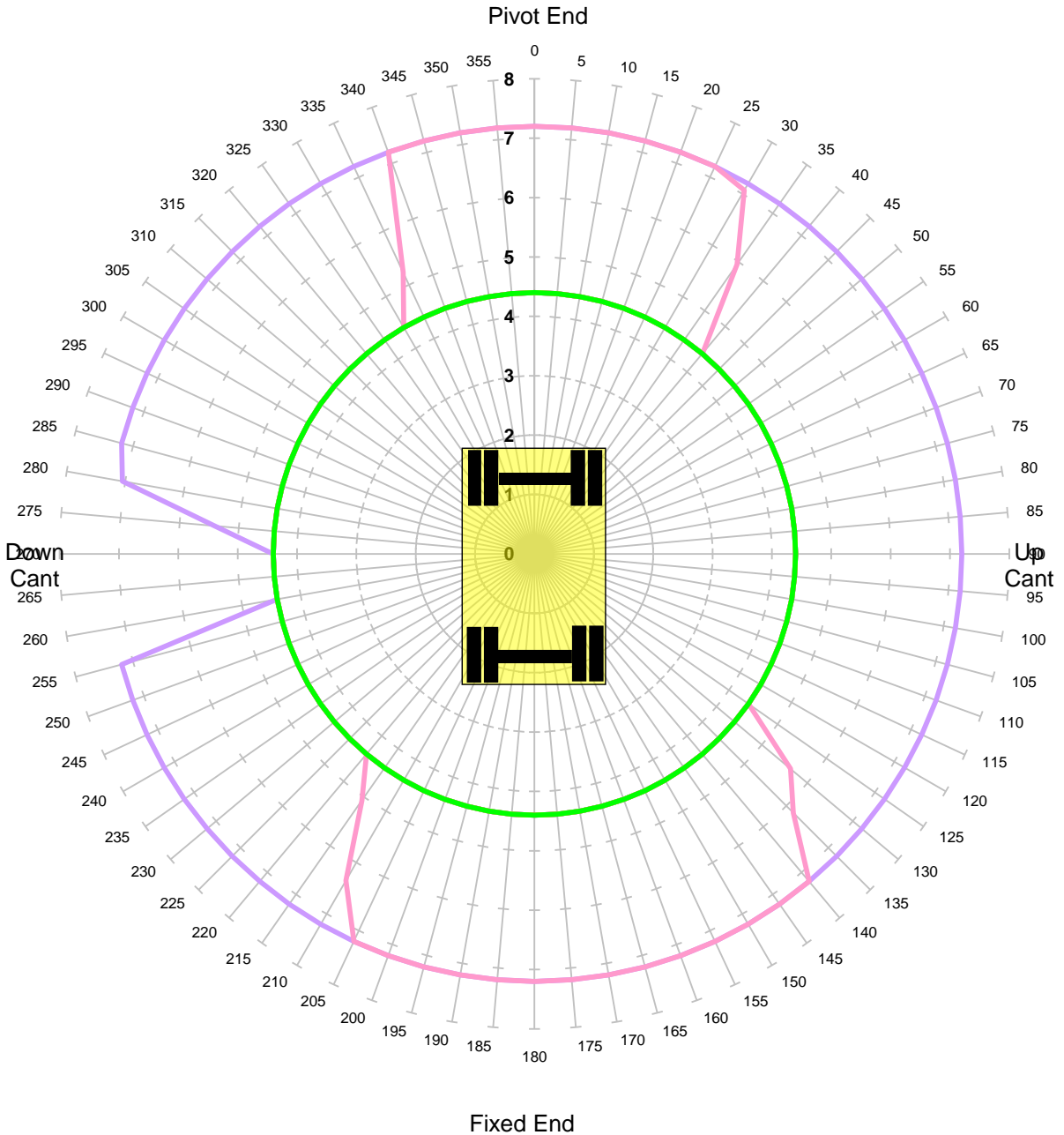

Units in Tonnes

- 1
- 2
- 3
- 4
- 5
- 6
- 7

MACHINE & MODEL:	Komatsu PW160-7	REFERENCE:	REXQUOTE
SERIAL No:	2345	DATE OF CHART:	24-Feb-2022
EQUIPMENT:	5.15m+2.1m	SAFETY FACTOR:	53.0%
COMMENT:			

Komatsu PW160-7
Max Capacity Contours of Radius(m) Plots 2.1m Dipper
Gradient 1 in -25 Height 2m Lift BP
Locked Rail Cant 150mm - Tandem Lift

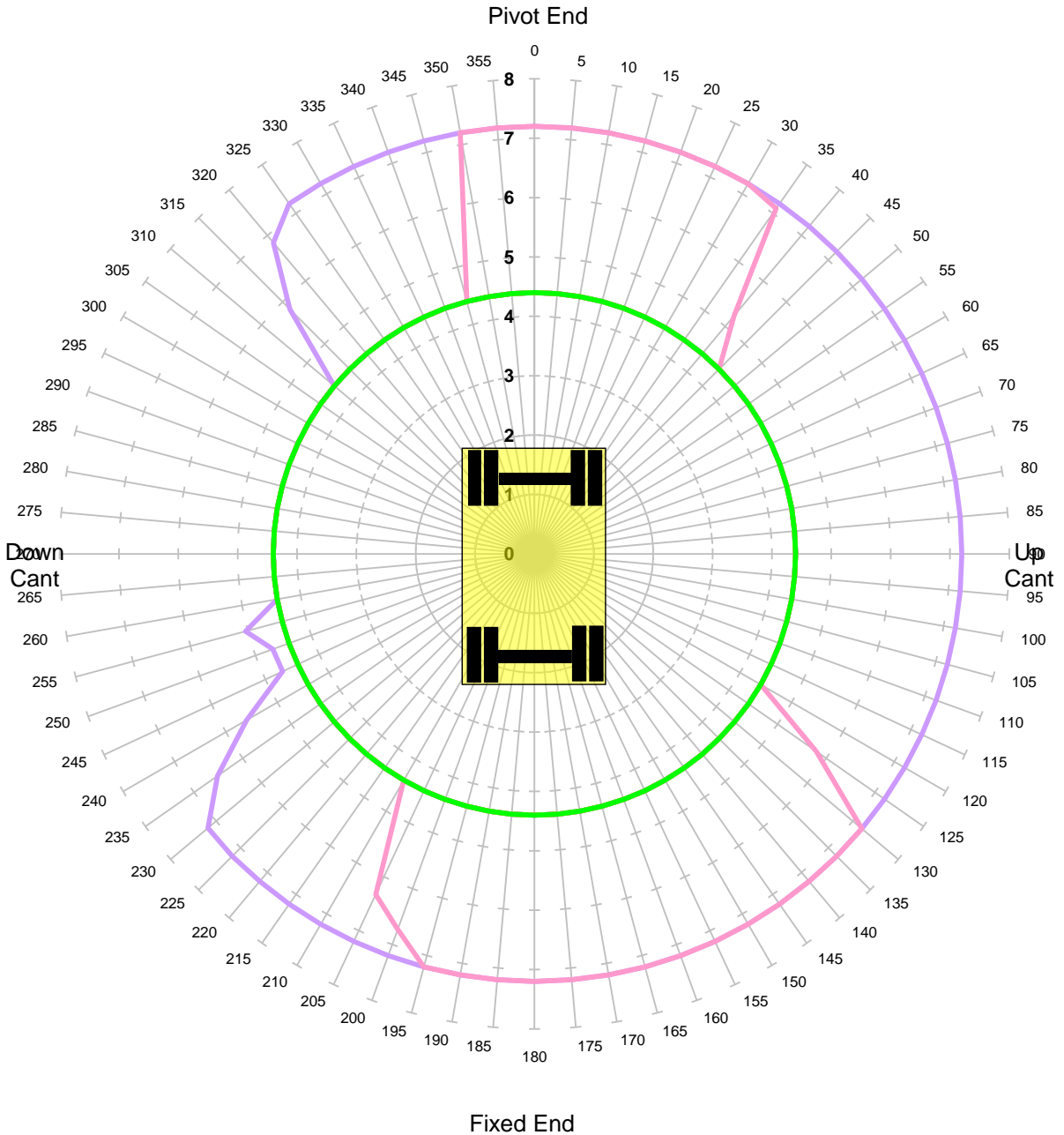

Units in Tonnes

- 1
- 2
- 3
- 4
- 5
- 6
- 7

MACHINE & MODEL:	Komatsu PW160-7	REFERENCE:	REXQUOTE
SERIAL No:	2345	DATE OF CHART:	24-Feb-2022
EQUIPMENT:	5.15m+2.1m	SAFETY FACTOR:	53.0%
COMMENT:			

Komatsu PW160-7
Max Capacity Contours of Radius(m) Plots 2.1m Dipper
Level Ground Height 2m Lift BP
Unlocked Road - Tandem Lift

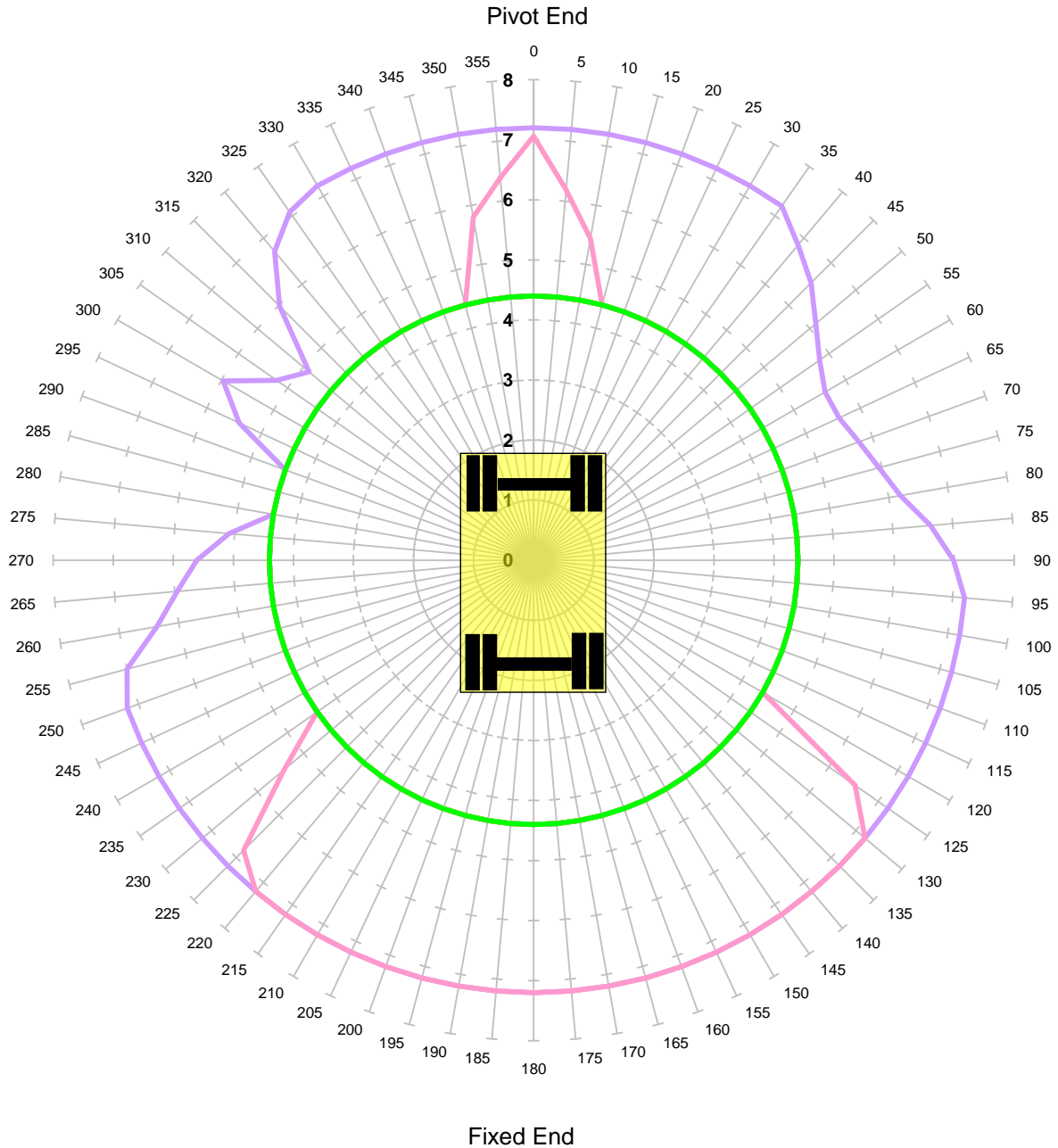

Units in Tonnes

- 1
 — 2
 — 3
 — 4
 — 5
 — 6
 — 7

MACHINE & MODEL:	Komatsu PW160-7	REFERENCE:	REXQUOTE
SERIAL No:	2345	DATE OF CHART:	24-Feb-2022
EQUIPMENT:	5.15m+2.1m	SAFETY FACTOR:	42.0%
COMMENT:			

Komatsu PW160-7
Max Capacity Contours of Radius(m) Plots 2.1m Dipper
Level Ground Height 2m Lift BP
Locked Road - Tandem Lift

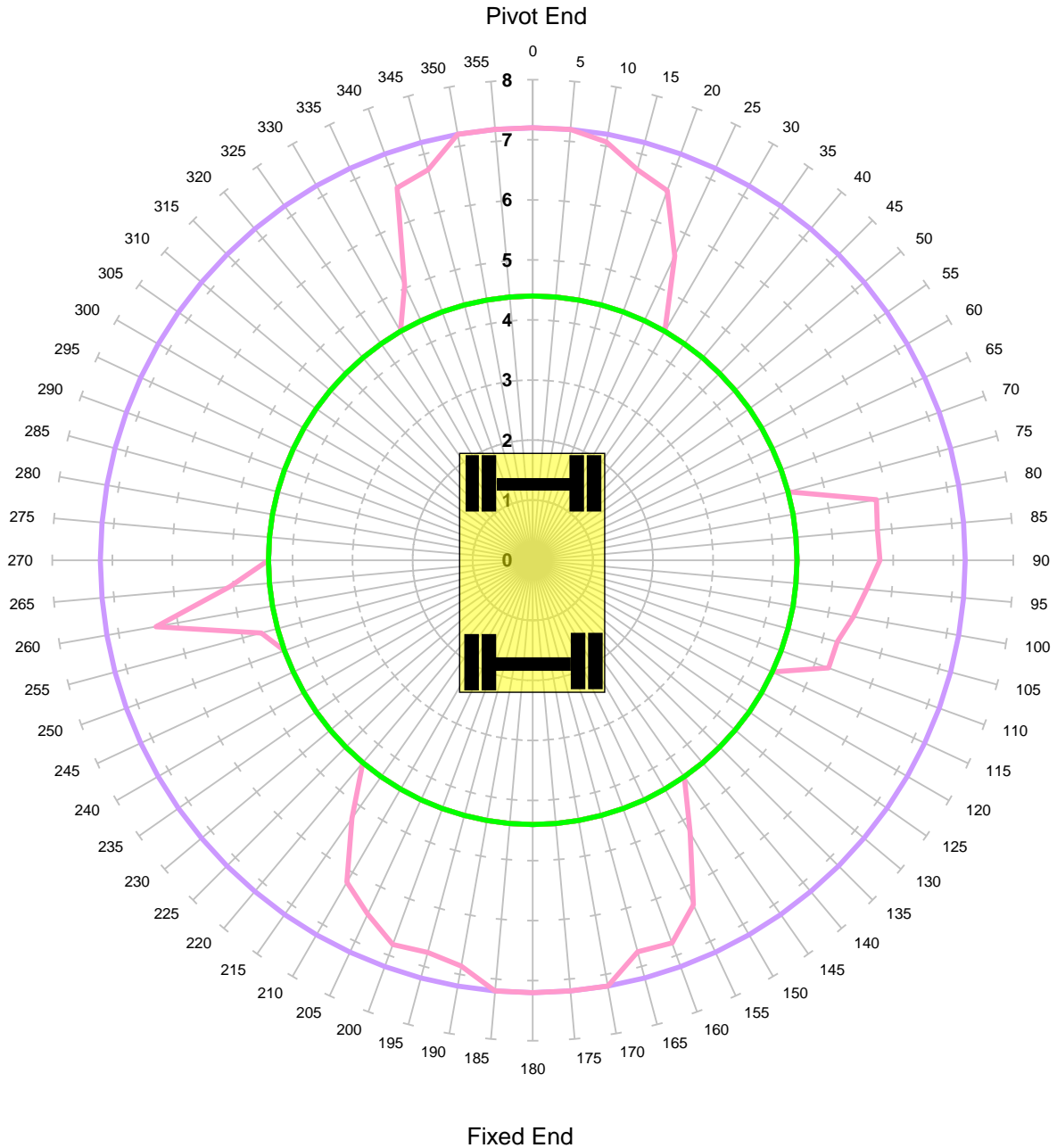

Units in Tonnes

- 1
 — 2
 — 3
 — 4
 — 5
 — 6
 — 7

MACHINE & MODEL:	Komatsu PW160-7	REFERENCE:	REXQUOTE
SERIAL No:	2345	DATE OF CHART:	24-Feb-2022
EQUIPMENT:	5.15m+2.1m	SAFETY FACTOR:	42.0%
COMMENT:			

Komatsu PW160-7
Max Capacity Contours of Radius(m) Plots 2.1m Dipper
Gradient 1 in -25 Height 2m Lift QH
Unlocked Rail Cant -150mm

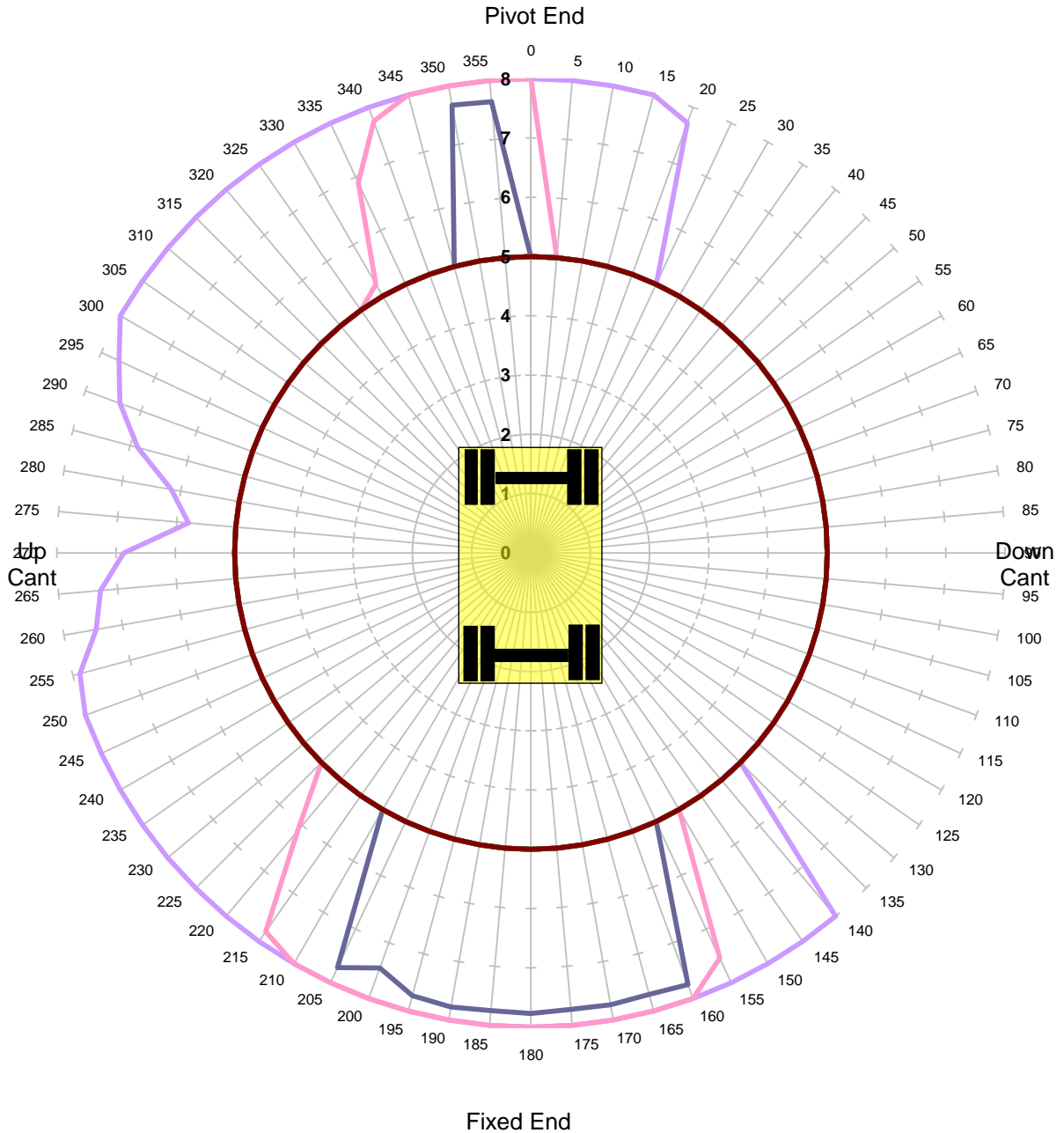

Units in Tonnes

- 1
- 2
- 3
- 4
- 5
- 6
- 7
- 8
- 9
- 10
- 11
- 12
- 13

MACHINE & MODEL:	Komatsu PW160-7	REFERENCE:	REXQUOTE
SERIAL No:	2345	DATE OF CHART:	24-Feb-2022
EQUIPMENT:	5.15m+2.1m	SAFETY FACTOR:	63.0%
COMMENT:			

Komatsu PW160-7
Max Capacity Contours of Radius(m) Plots 2.1m Dipper
Gradient 1 in -25 Height 2m Lift QH
Unlocked Rail Cant -50mm

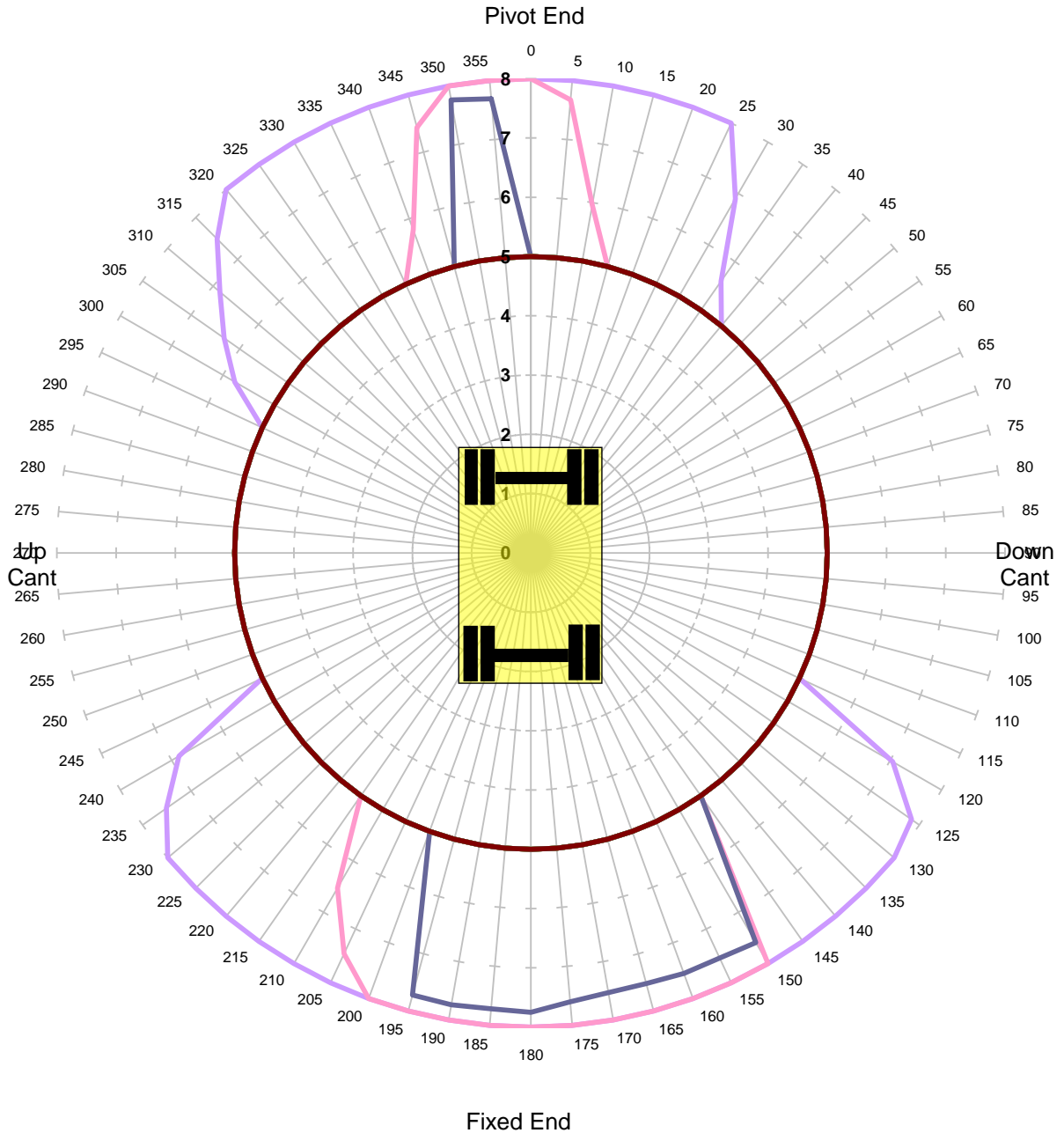

Units in Tonnes

- 1
- 2
- 3
- 4
- 5
- 6
- 7
- 8
- 9
- 10
- 11
- 12
- 13

MACHINE & MODEL:	Komatsu PW160-7	REFERENCE:	REXQUOTE
SERIAL No:	2345	DATE OF CHART:	24-Feb-2022
EQUIPMENT:	5.15m+2.1m	SAFETY FACTOR:	63.0%
COMMENT:			

Komatsu PW160-7
Max Capacity Contours of Radius(m) Plots 2.1m Dipper
Gradient 1 in -25 Height 2m Lift QH
Unlocked Rail Cant 50mm

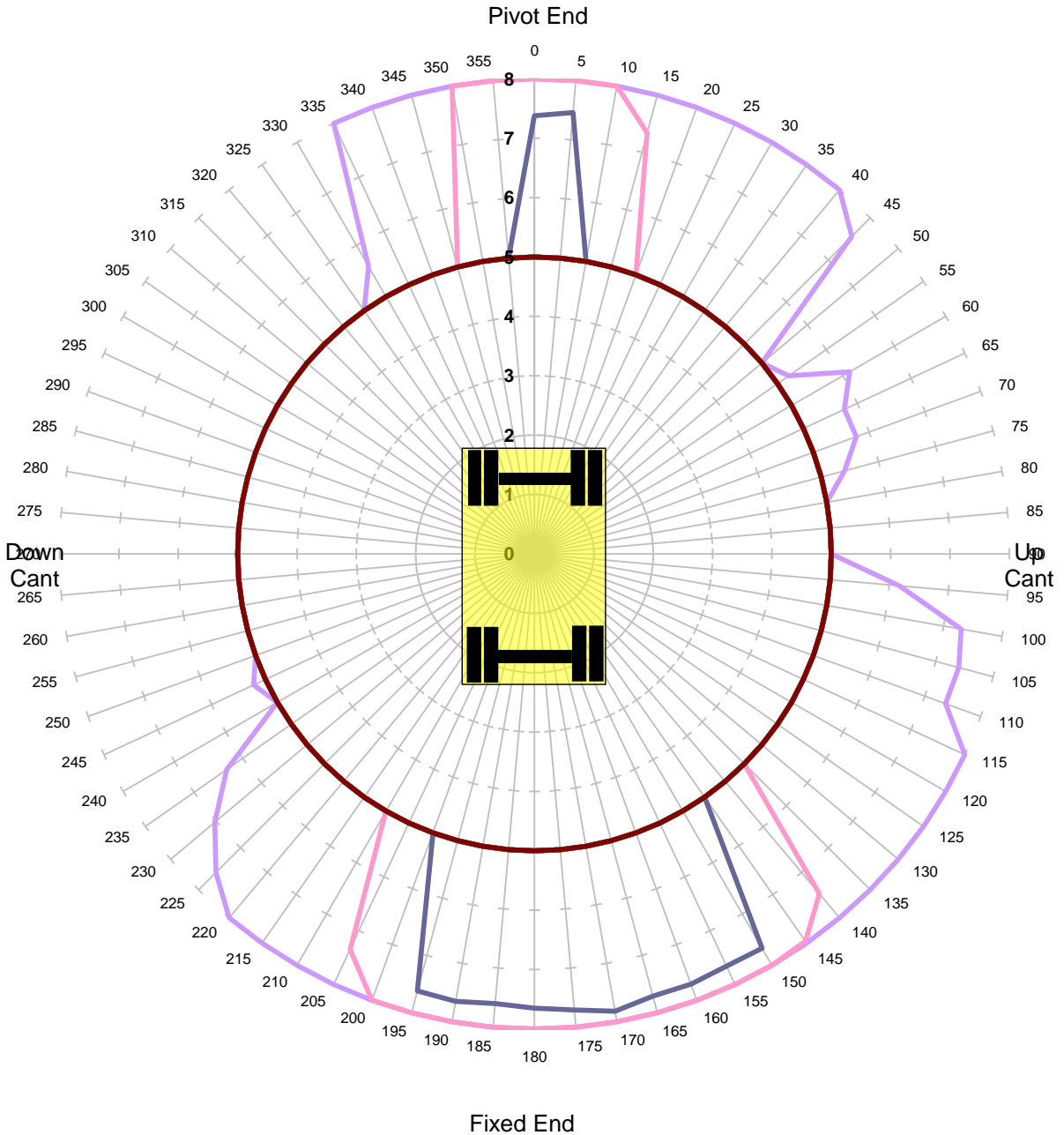

Units in Tonnes

- 1
- 2
- 3
- 4
- 5
- 6
- 7
- 8
- 9
- 10
- 11
- 12
- 13

MACHINE & MODEL:	Komatsu PW160-7	REFERENCE:	REXQUOTE
SERIAL No:	2345	DATE OF CHART:	24-Feb-2022
EQUIPMENT:	5.15m+2.1m	SAFETY FACTOR:	63.0%
COMMENT:			

Komatsu PW160-7
Max Capacity Contours of Radius(m) Plots 2.1m Dipper
Gradient 1 in -25 Height 2m Lift QH
Unlocked Rail Cant 150mm

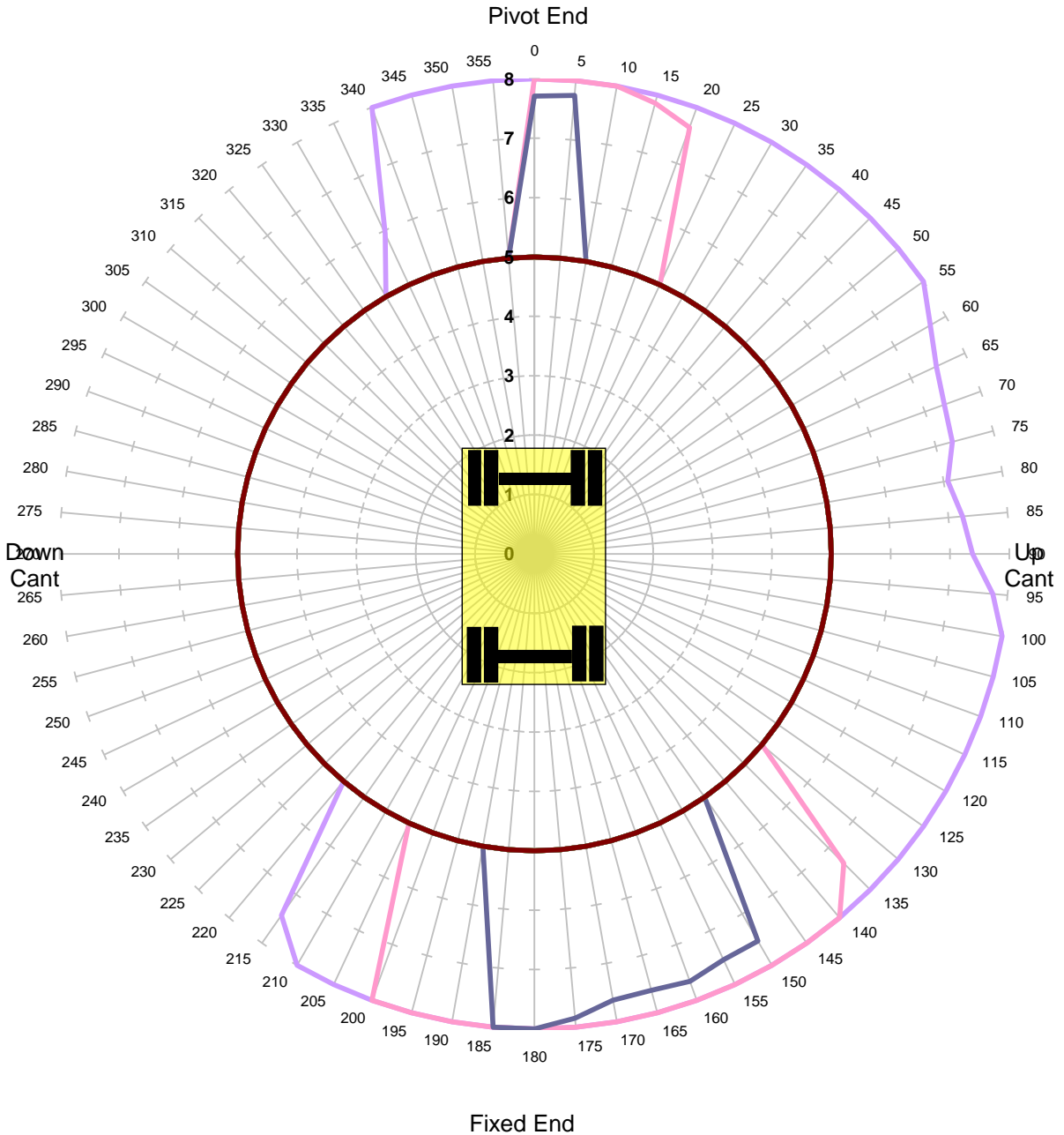

Units in Tonnes

- 1
- 2
- 3
- 4
- 5
- 6
- 7
- 8
- 9
- 10
- 11
- 12
- 13

MACHINE & MODEL:	Komatsu PW160-7	REFERENCE:	REXQUOTE
SERIAL No:	2345	DATE OF CHART:	24-Feb-2022
EQUIPMENT:	5.15m+2.1m	SAFETY FACTOR:	63.0%
COMMENT:			

Komatsu PW160-7
Max Capacity Contours of Radius(m) Plots 2.1m Dipper
Gradient 1 in -25 Height 2m Lift QH
Locked Rail Cant -150mm

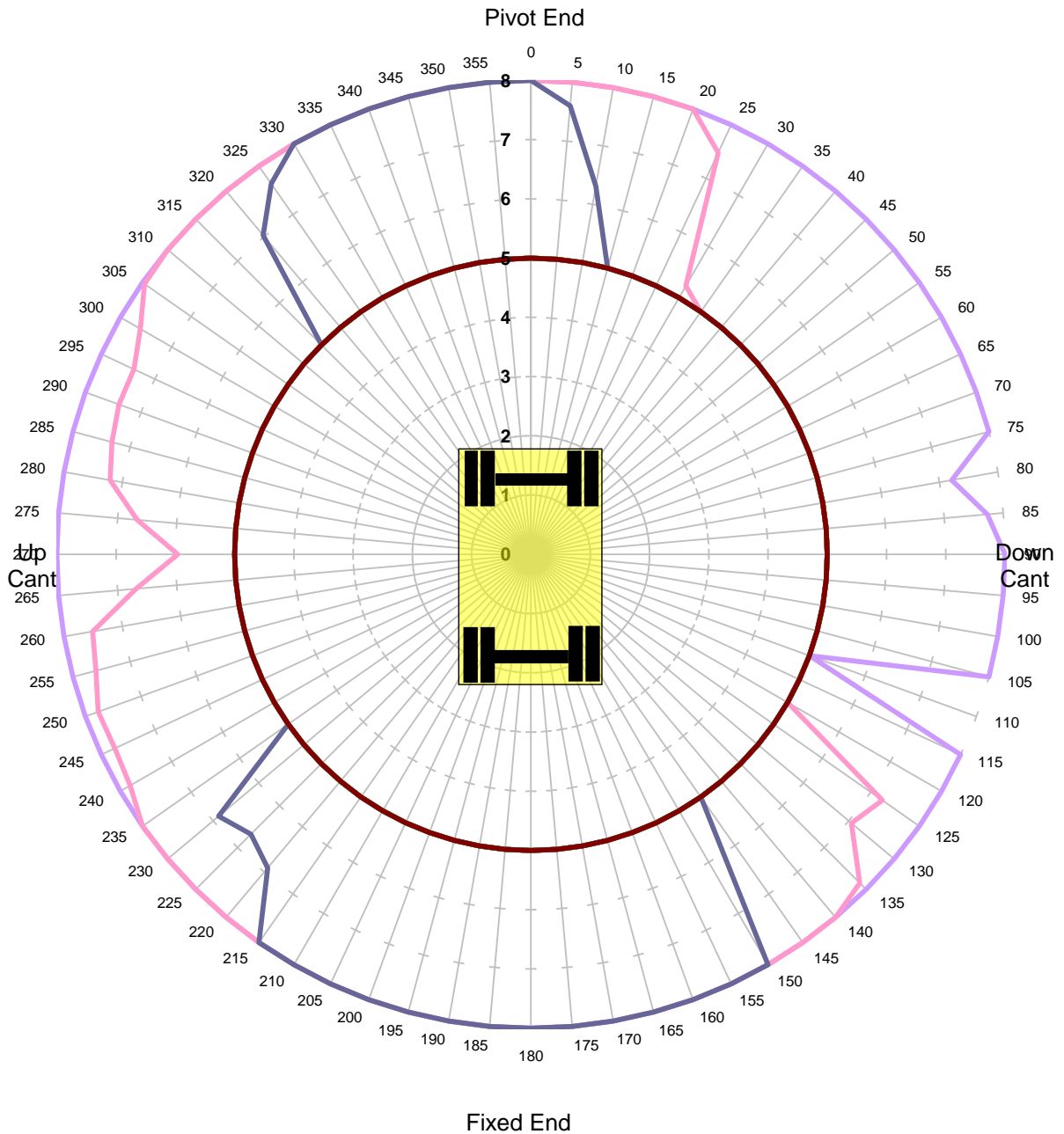

Units in Tonnes

- 1
- 2
- 3
- 4
- 5
- 6
- 7
- 8
- 9
- 10
- 11
- 12
- 13

MACHINE & MODEL:	Komatsu PW160-7	REFERENCE:	REXQUOTE
SERIAL No:	2345	DATE OF CHART:	24-Feb-2022
EQUIPMENT:	5.15m+2.1m	SAFETY FACTOR:	85.0%
COMMENT:			

Komatsu PW160-7
Max Capacity Contours of Radius(m) Plots 2.1m Dipper
Gradient 1 in -25 Height 2m Lift QH
Locked Rail Cant -50mm

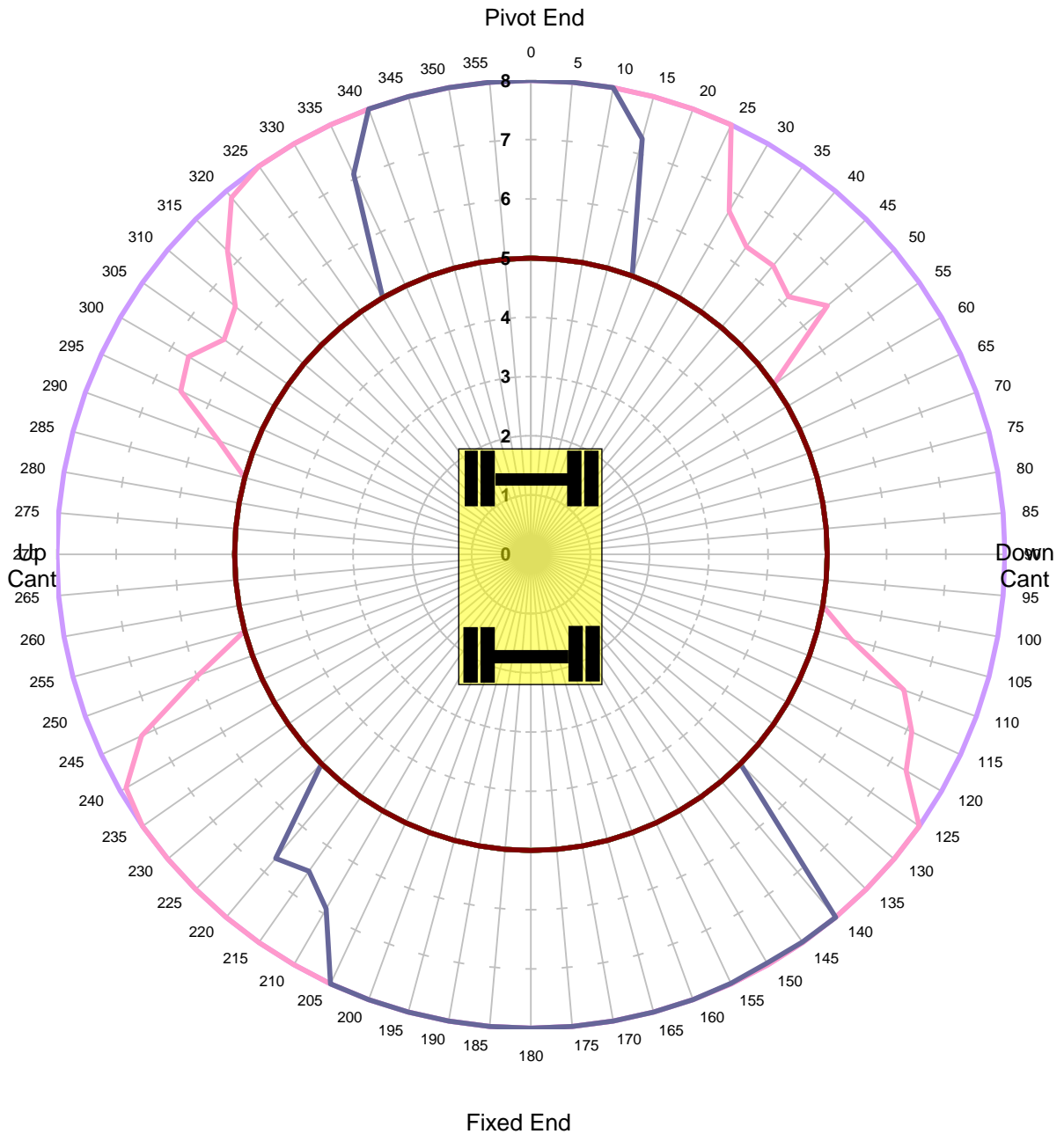

Units in Tonnes

- 1
- 2
- 3
- 4
- 5
- 6
- 7
- 8
- 9
- 10
- 11
- 12
- 13

MACHINE & MODEL:	Komatsu PW160-7	REFERENCE:	REXQUOTE
SERIAL No:	2345	DATE OF CHART:	24-Feb-2022
EQUIPMENT:	5.15m+2.1m	SAFETY FACTOR:	85.0%
COMMENT:			

Komatsu PW160-7
Max Capacity Contours of Radius(m) Plots 2.1m Dipper
Gradient 1 in -25 Height 2m Lift QH
Locked Rail Cant 50mm

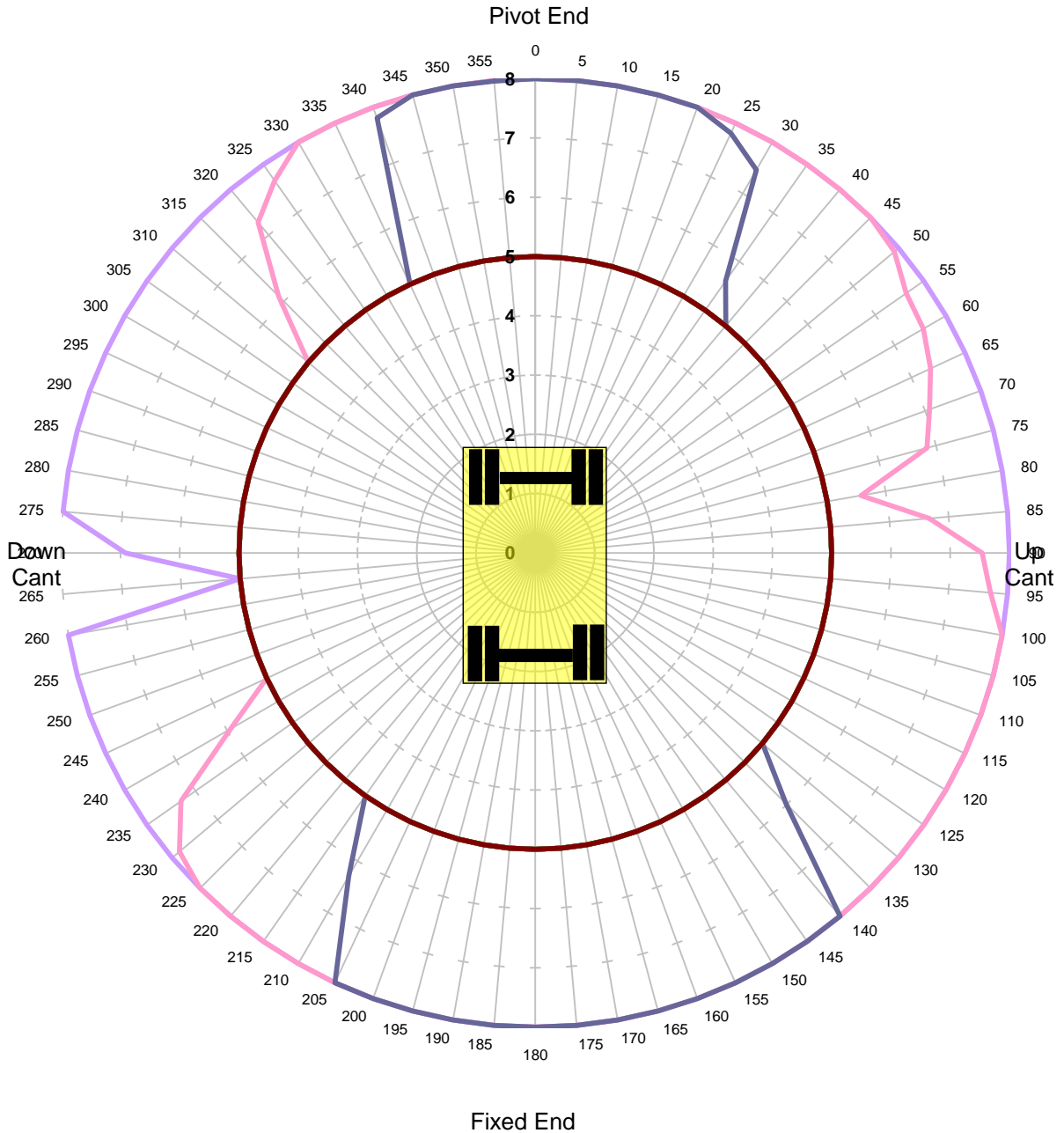

Units in Tonnes

- 1
- 2
- 3
- 4
- 5
- 6
- 7
- 8
- 9
- 10
- 11
- 12
- 13

MACHINE & MODEL:	Komatsu PW160-7	REFERENCE:	REXQUOTE
SERIAL No:	2345	DATE OF CHART:	24-Feb-2022
EQUIPMENT:	5.15m+2.1m	SAFETY FACTOR:	85.0%
COMMENT:			

Komatsu PW160-7
Max Capacity Contours of Radius(m) Plots 2.1m Dipper
Gradient 1 in -25 Height 2m Lift QH
Locked Rail Cant 150mm

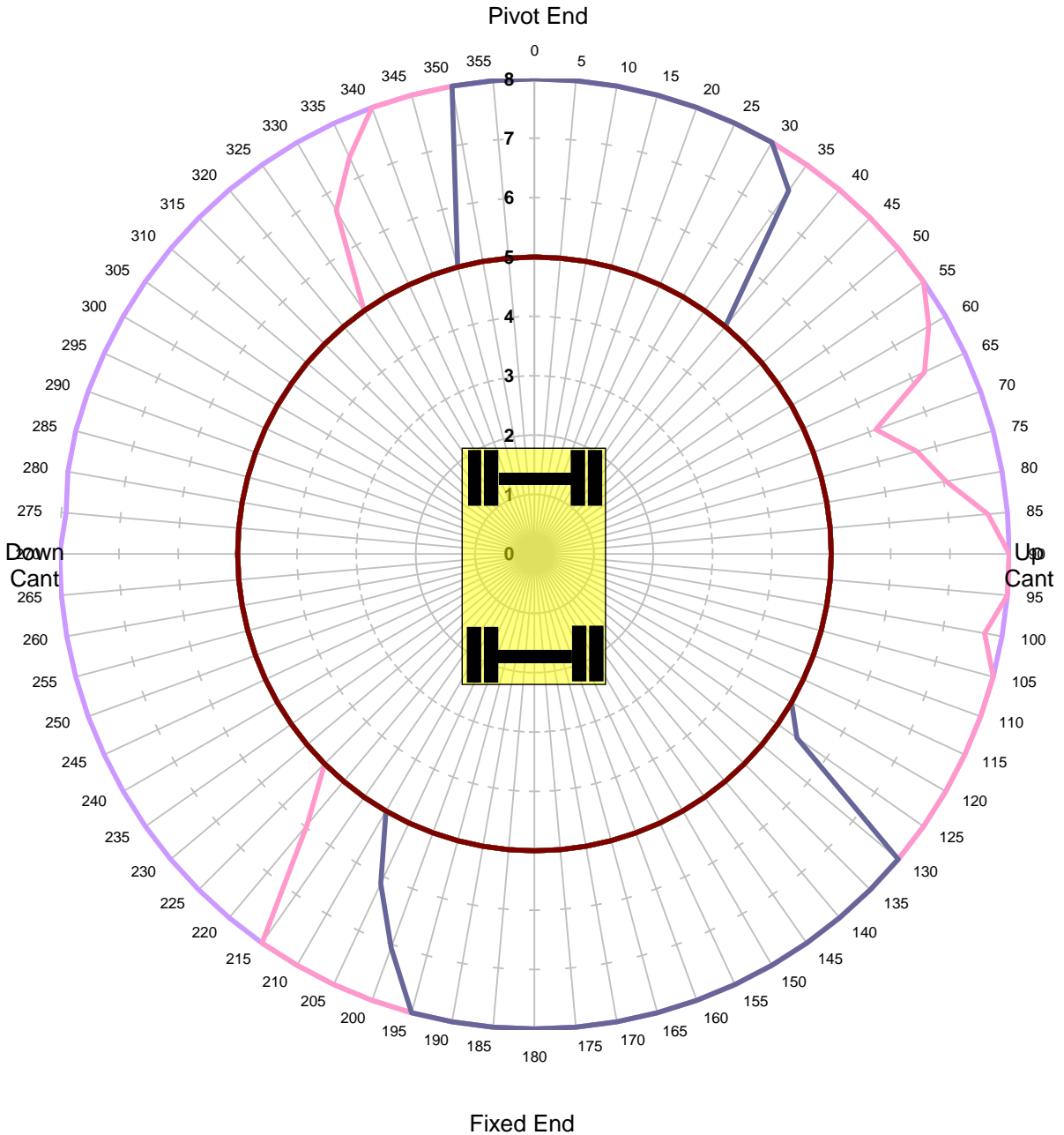

MACHINE & MODEL:	Komatsu PW160-7	REFERENCE:	REXQUOTE
SERIAL No:	2345	DATE OF CHART:	24-Feb-2022
EQUIPMENT:	5.15m+2.1m	SAFETY FACTOR:	85.0%
COMMENT:			

Komatsu PW160-7
Max Capacity Contours of Radius(m) Plots 2.1m Dipper
Level Ground Height 2m Lift QH
Unlocked Road

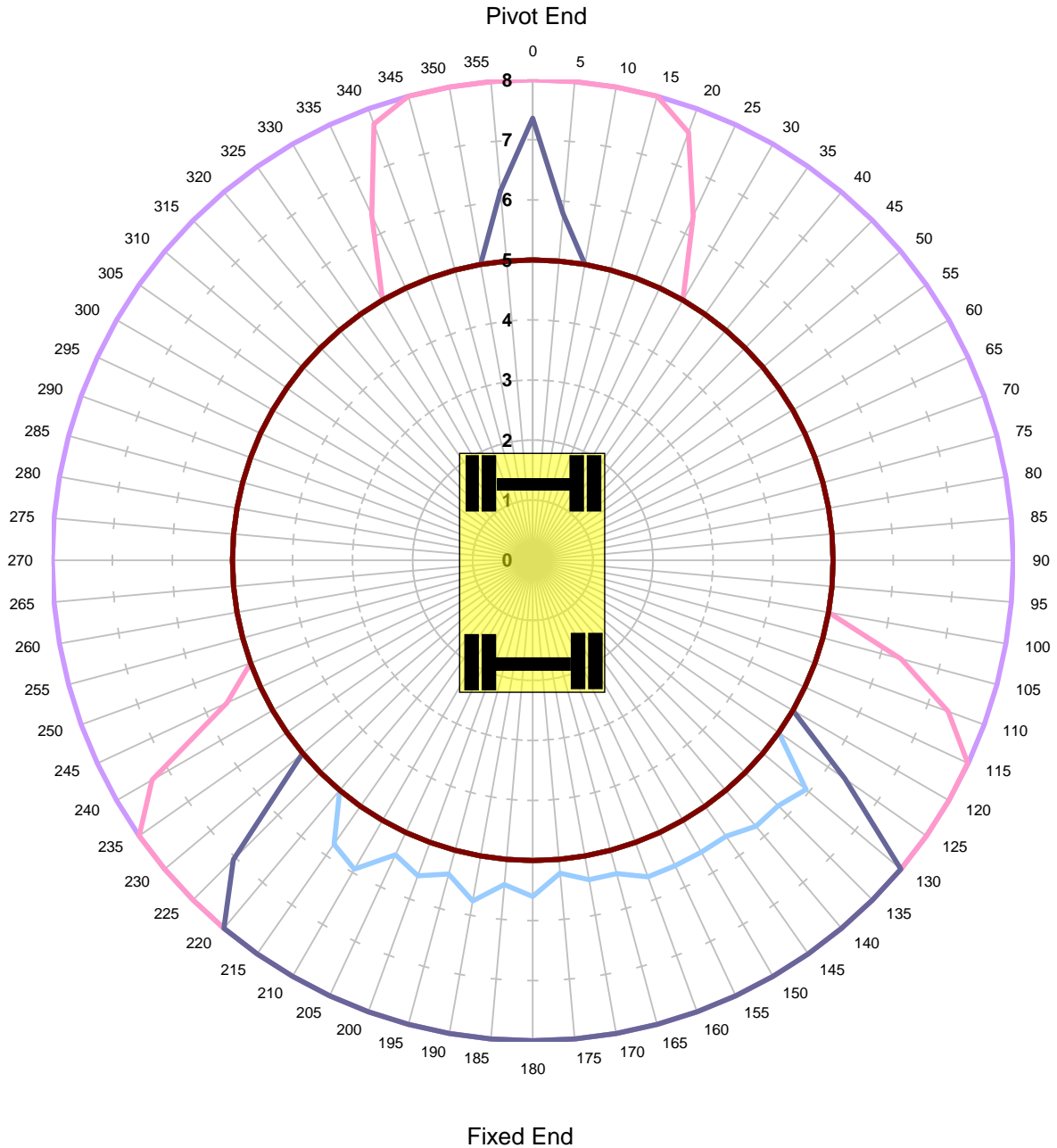

Units in Tonnes

- 1
- 2
- 3
- 4
- 5
- 6
- 7
- 8
- 9
- 10
- 11
- 12
- 13

MACHINE & MODEL:	Komatsu PW160-7	REFERENCE:	REXQUOTE
SERIAL No:	2345	DATE OF CHART:	24-Feb-2022
EQUIPMENT:	5.15m+2.1m	SAFETY FACTOR:	67.0%
COMMENT:			

Komatsu PW160-7
Max Capacity Contours of Radius(m) Plots 2.1m Dipper
Level Ground Height 2m Lift QH
Locked Road

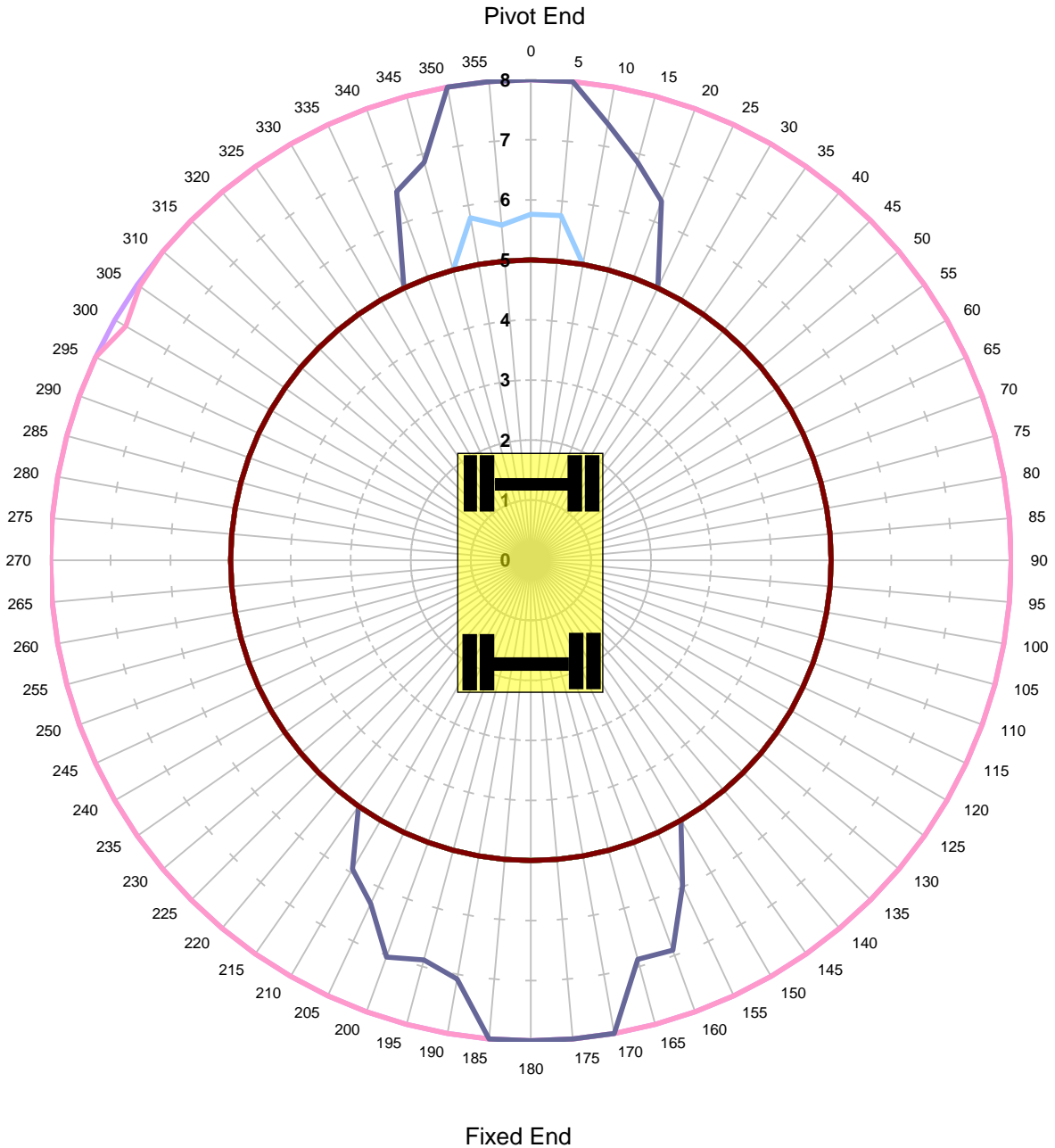

Units in Tonnes

- 1
- 2
- 3
- 4
- 5
- 6
- 7
- 8
- 9
- 10
- 11
- 12
- 13

MACHINE & MODEL:	Komatsu PW160-7	REFERENCE:	REXQUOTE
SERIAL No:	2345	DATE OF CHART:	24-Feb-2022
EQUIPMENT:	5.15m+2.1m	SAFETY FACTOR:	67.0%
COMMENT:			

Komatsu PW160-7
Max Capacity Contours of Radius(m) Plots 2.1m Dipper
Gradient 1 in -25 Height 2m Lift QH
Unlocked Rail Cant -150mm - Tandem Lift

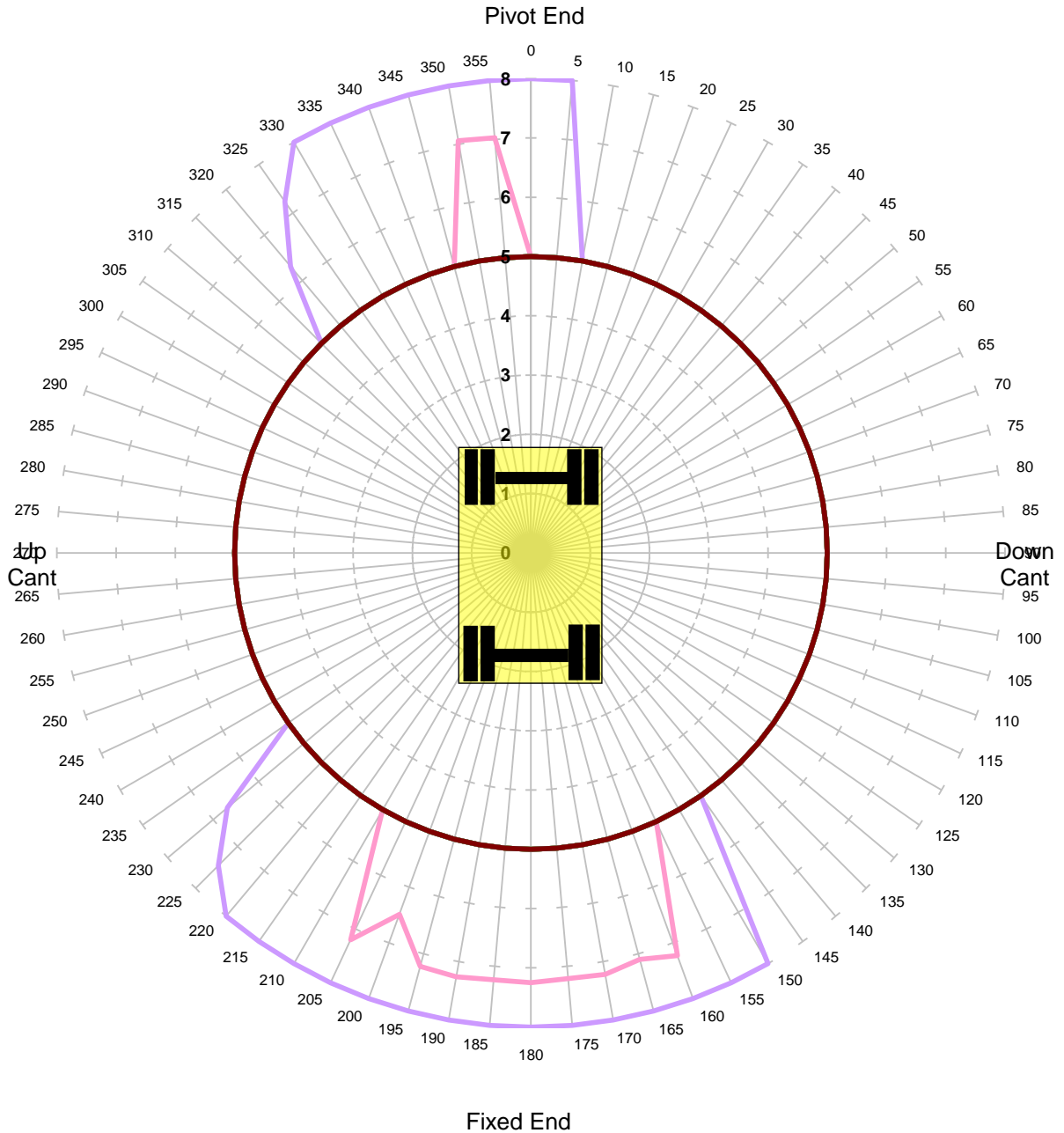

Units in Tonnes

- 1
- 2
- 3
- 4
- 5
- 6
- 7
- 8
- 9
- 10
- 11
- 12
- 13

MACHINE & MODEL:	Komatsu PW160-7	REFERENCE:	REXQUOTE
SERIAL No:	2345	DATE OF CHART:	24-Feb-2022
EQUIPMENT:	5.15m+2.1m	SAFETY FACTOR:	39.0%
COMMENT:			

Komatsu PW160-7
Max Capacity Contours of Radius(m) Plots 2.1m Dipper
Gradient 1 in -25 Height 2m Lift QH
Unlocked Rail Cant -50mm - Tandem Lift

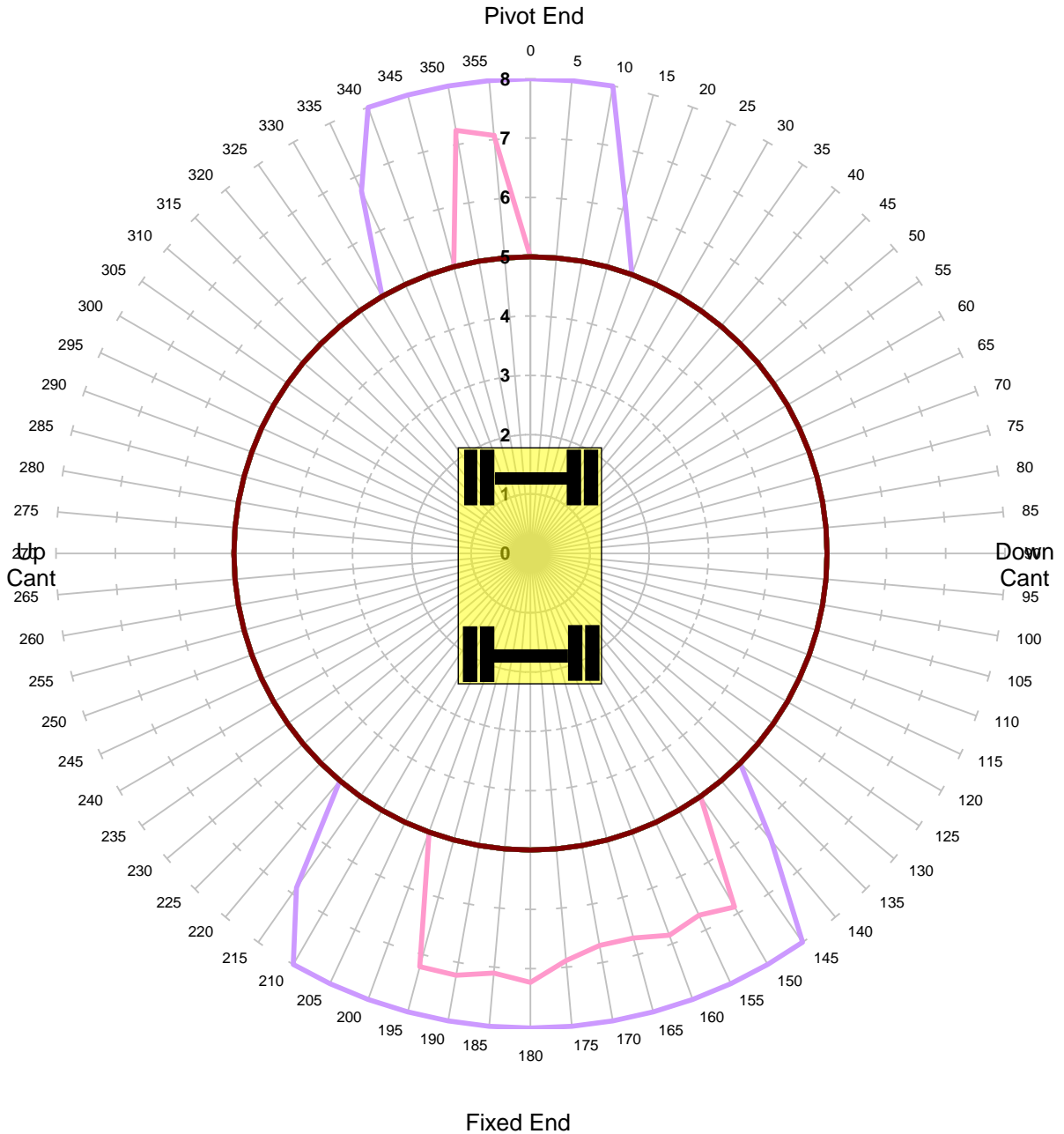

Units in Tonnes

- 1
- 2
- 3
- 4
- 5
- 6
- 7
- 8
- 9
- 10
- 11
- 12
- 13

MACHINE & MODEL:	Komatsu PW160-7	REFERENCE:	REXQUOTE
SERIAL No:	2345	DATE OF CHART:	24-Feb-2022
EQUIPMENT:	5.15m+2.1m	SAFETY FACTOR:	39.0%
COMMENT:			

Komatsu PW160-7
Max Capacity Contours of Radius(m) Plots 2.1m Dipper
Gradient 1 in -25 Height 2m Lift QH
Unlocked Rail Cant 50mm - Tandem Lift

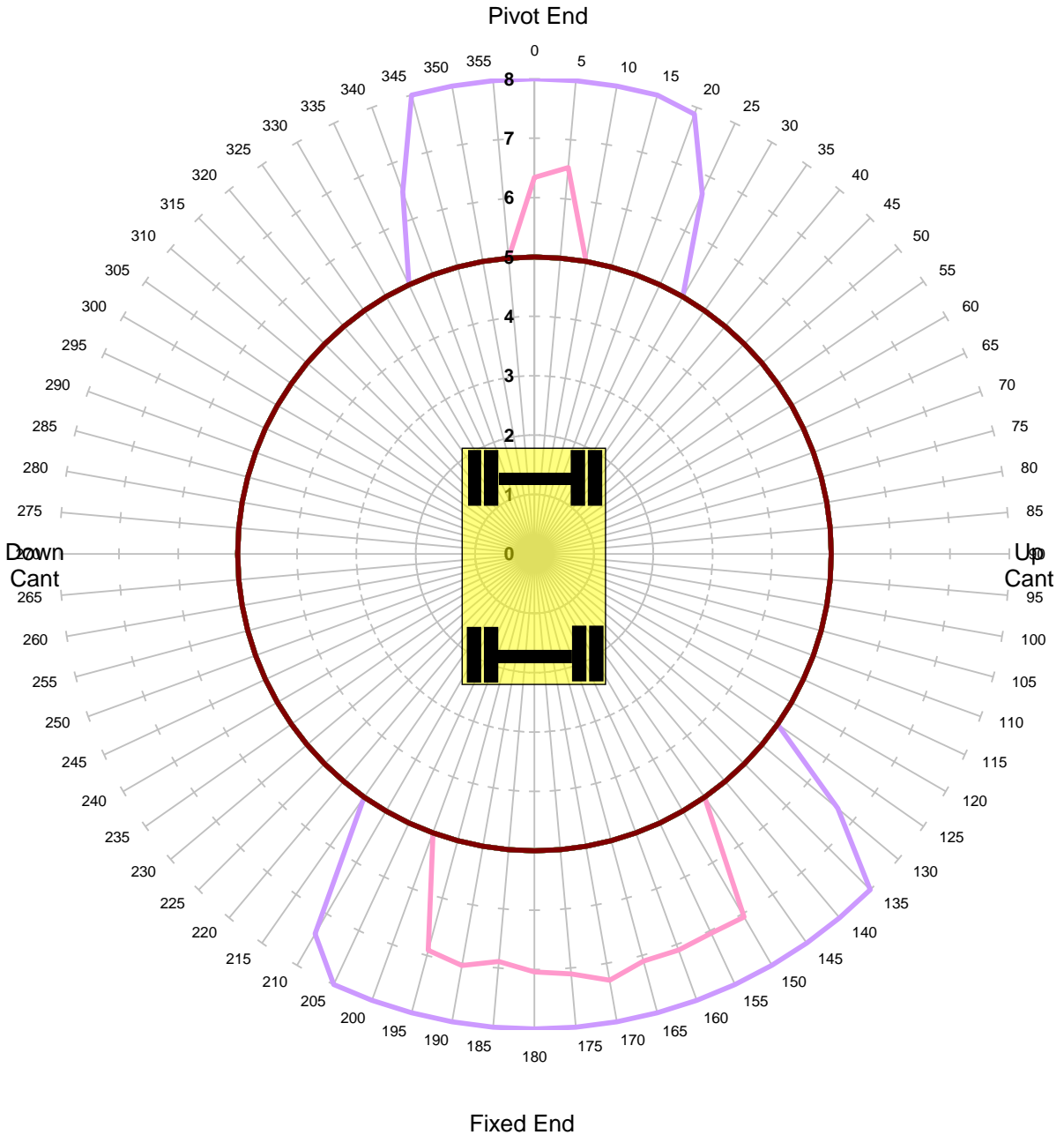

Units in Tonnes

- 1
- 2
- 3
- 4
- 5
- 6
- 7
- 8
- 9
- 10
- 11
- 12
- 13

MACHINE & MODEL:	Komatsu PW160-7	REFERENCE:	REXQUOTE
SERIAL No:	2345	DATE OF CHART:	24-Feb-2022
EQUIPMENT:	5.15m+2.1m	SAFETY FACTOR:	39.0%
COMMENT:			

Komatsu PW160-7
Max Capacity Contours of Radius(m) Plots 2.1m Dipper
Gradient 1 in -25 Height 2m Lift QH
Unlocked Rail Cant 150mm - Tandem Lift

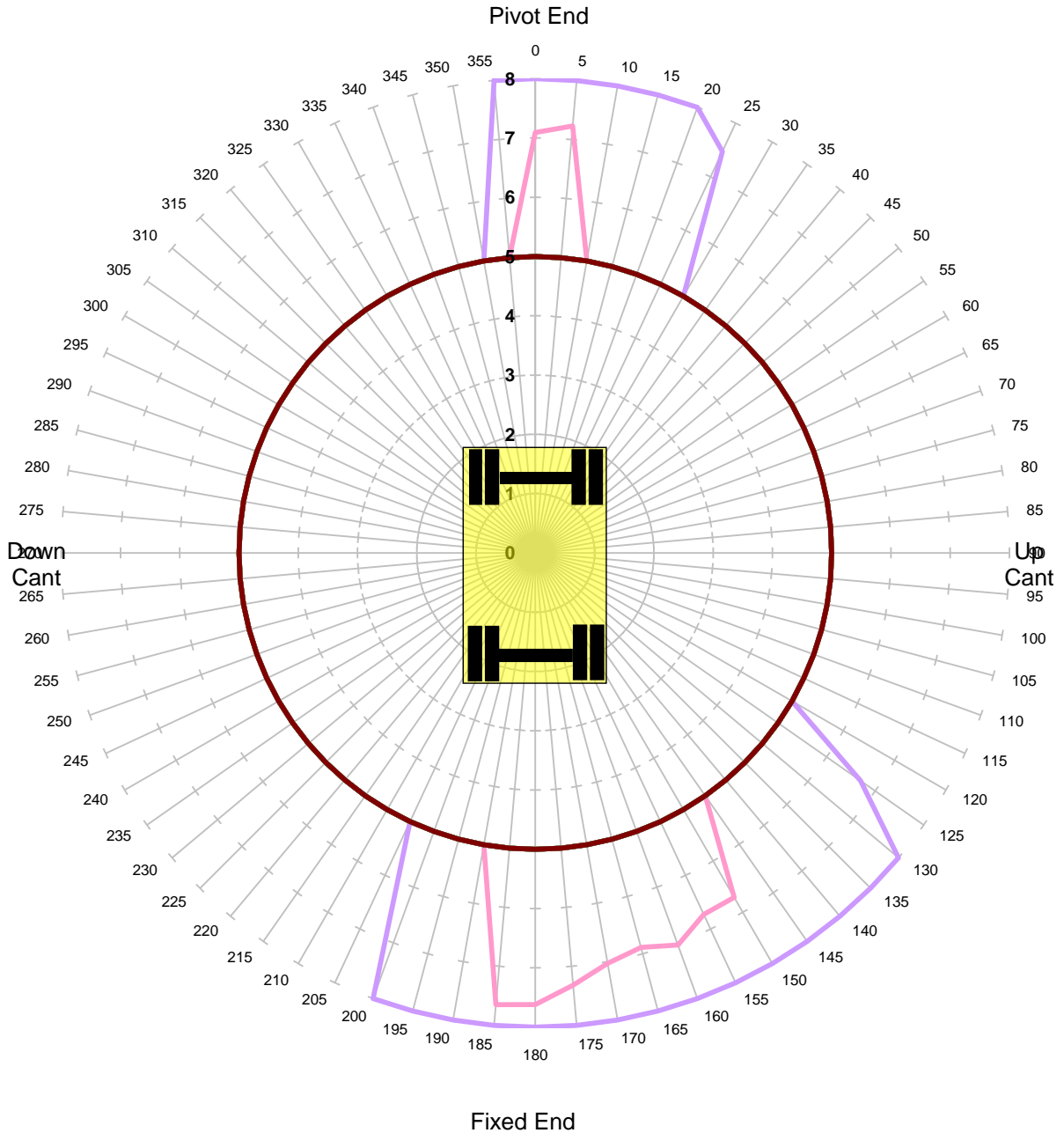

Units in Tonnes

- 1
- 2
- 3
- 4
- 5
- 6
- 7
- 8
- 9
- 10
- 11
- 12
- 13

MACHINE & MODEL:	Komatsu PW160-7	REFERENCE:	REXQUOTE
SERIAL No:	2345	DATE OF CHART:	24-Feb-2022
EQUIPMENT:	5.15m+2.1m	SAFETY FACTOR:	39.0%
COMMENT:			

Komatsu PW160-7
Max Capacity Contours of Radius(m) Plots 2.1m Dipper
Gradient 1 in -25 Height 2m Lift QH
Locked Rail Cant -150mm - Tandem Lift

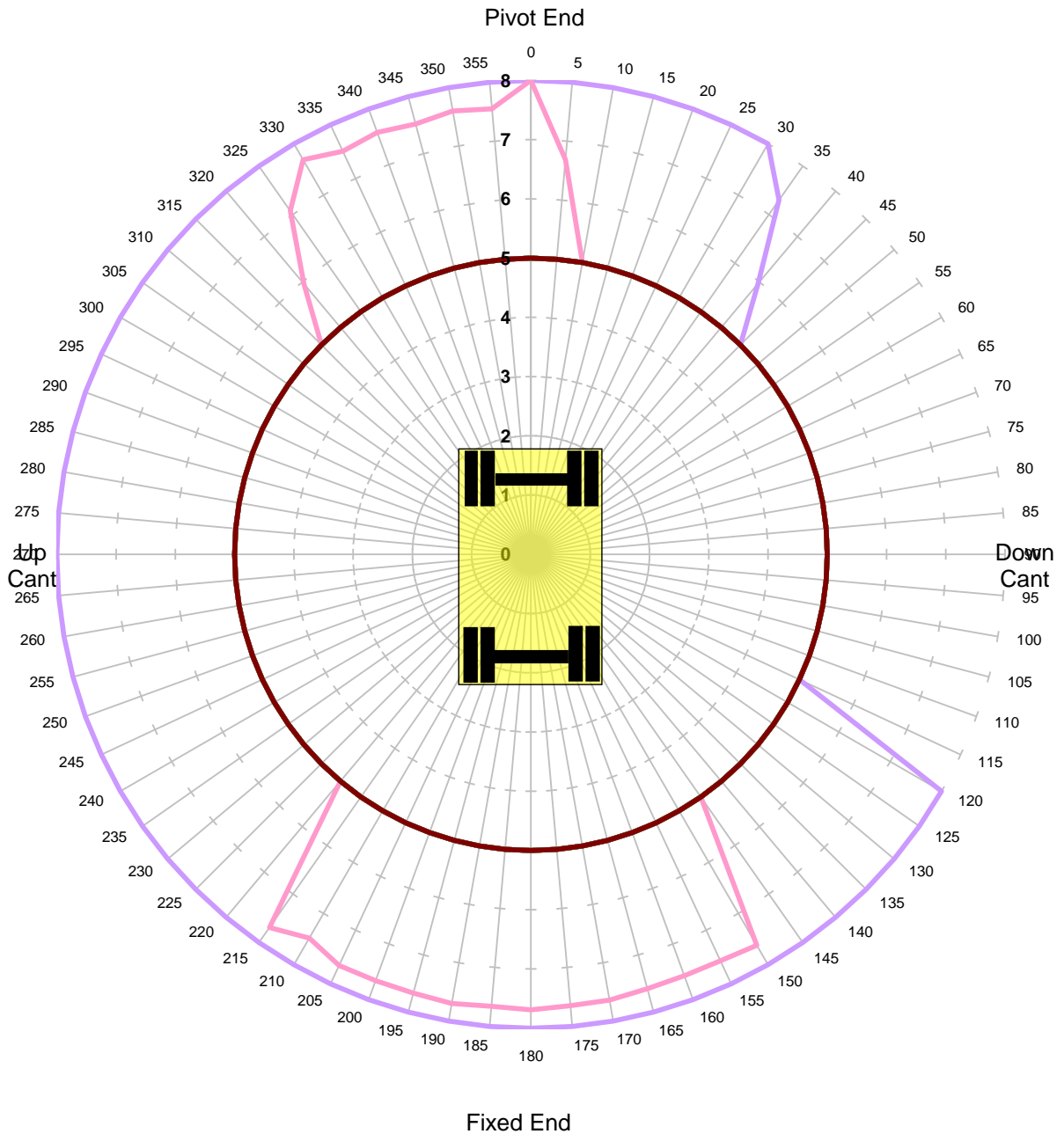

Units in Tonnes

- 1
- 2
- 3
- 4
- 5
- 6
- 7
- 8
- 9
- 10
- 11
- 12
- 13

MACHINE & MODEL:	Komatsu PW160-7	REFERENCE:	REXQUOTE
SERIAL No:	2345	DATE OF CHART:	24-Feb-2022
EQUIPMENT:	5.15m+2.1m	SAFETY FACTOR:	53.0%
COMMENT:			

Komatsu PW160-7
Max Capacity Contours of Radius(m) Plots 2.1m Dipper
Gradient 1 in -25 Height 2m Lift QH
Locked Rail Cant -50mm - Tandem Lift

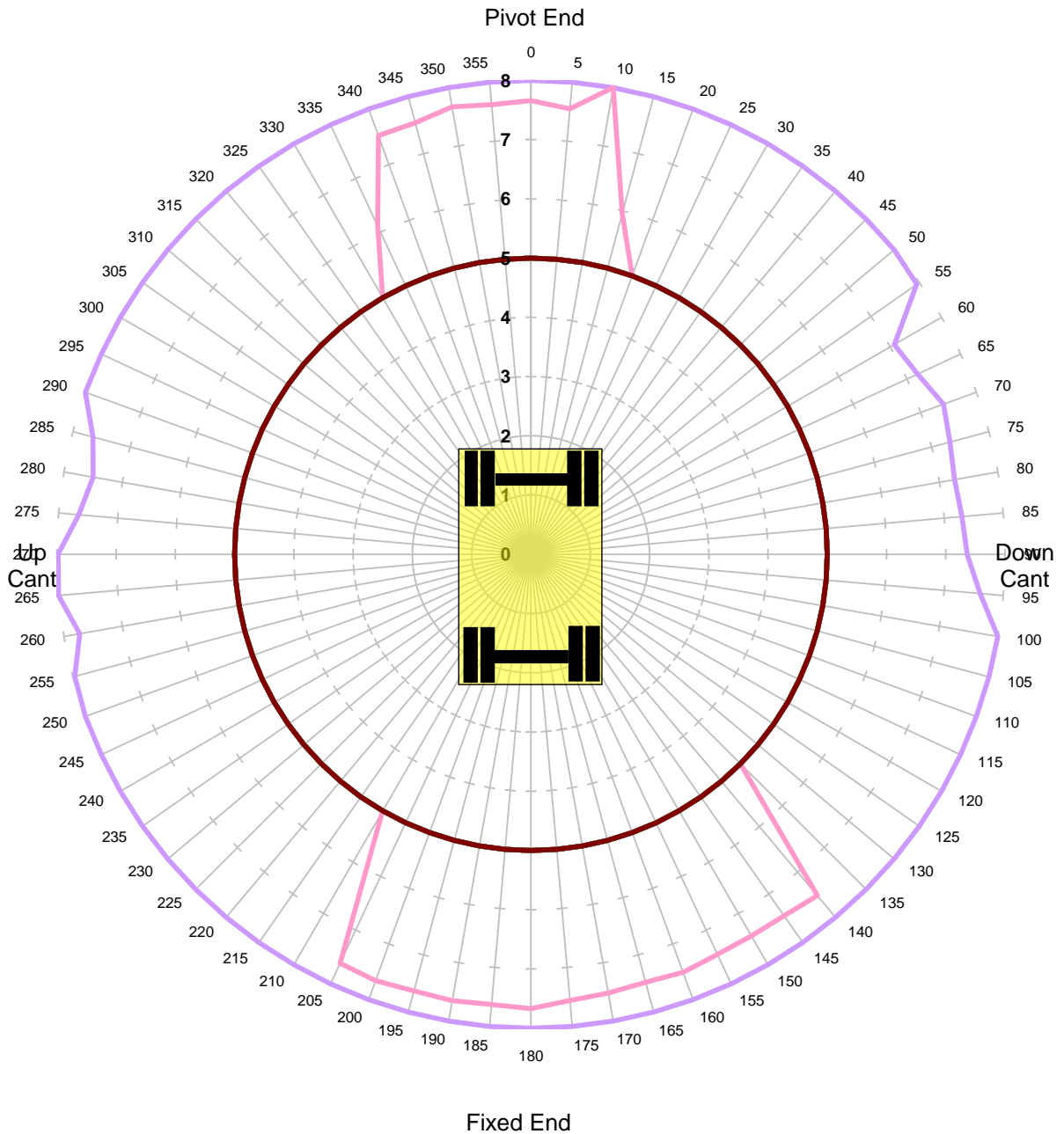

Units in Tonnes

- 1
- 2
- 3
- 4
- 5
- 6
- 7
- 8
- 9
- 10
- 11
- 12
- 13

MACHINE & MODEL:	Komatsu PW160-7	REFERENCE:	REXQUOTE
SERIAL No:	2345	DATE OF CHART:	24-Feb-2022
EQUIPMENT:	5.15m+2.1m	SAFETY FACTOR:	53.0%
COMMENT:			

Komatsu PW160-7
Max Capacity Contours of Radius(m) Plots 2.1m Dipper
Gradient 1 in -25 Height 2m Lift QH
Locked Rail Cant 50mm - Tandem Lift

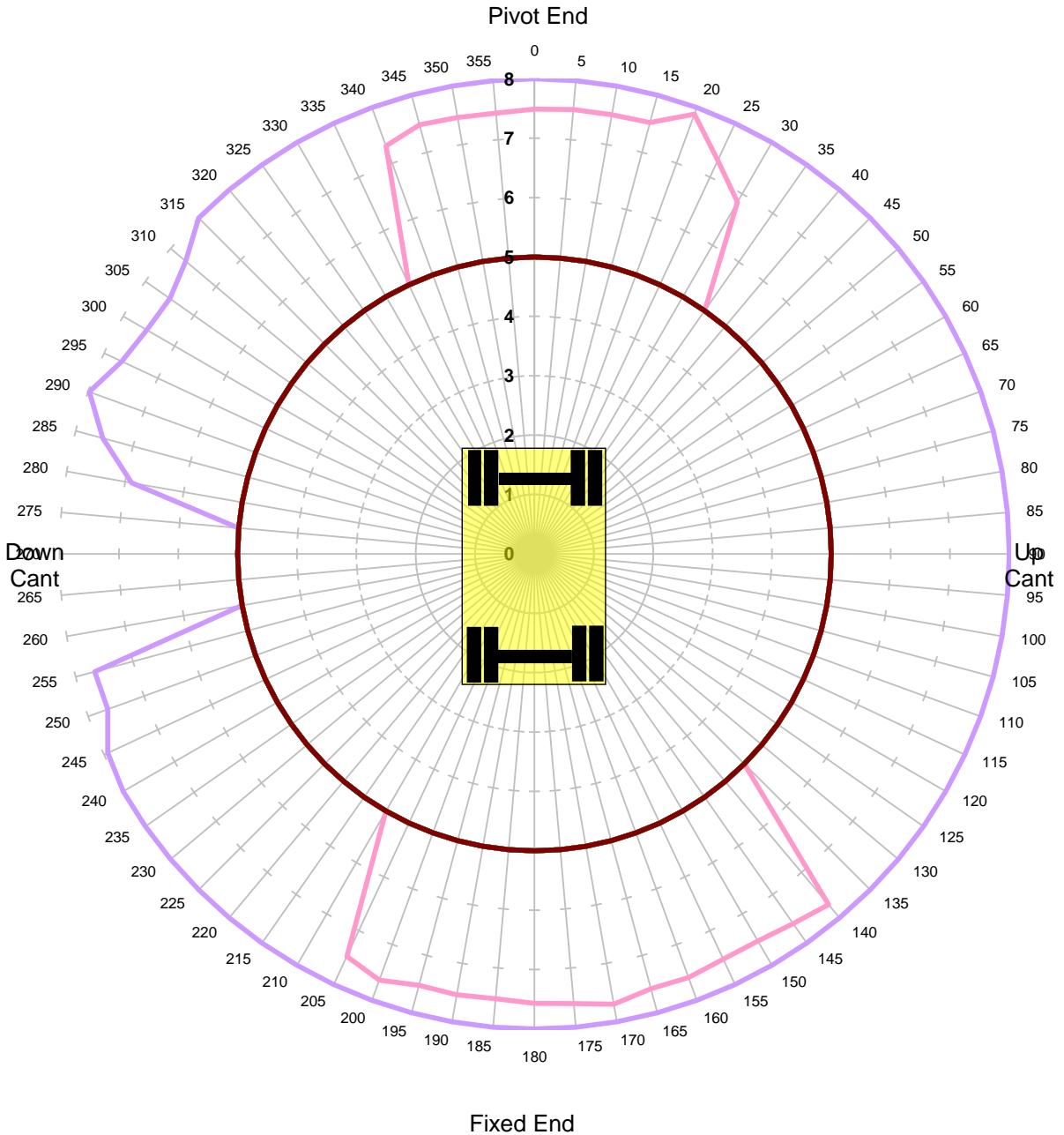

Units in Tonnes

- 1
- 2
- 3
- 4
- 5
- 6
- 7
- 8
- 9
- 10
- 11
- 12
- 13

MACHINE & MODEL:	Komatsu PW160-7	REFERENCE:	REXQUOTE
SERIAL No:	2345	DATE OF CHART:	24-Feb-2022
EQUIPMENT:	5.15m+2.1m	SAFETY FACTOR:	53.0%
COMMENT:			

Komatsu PW160-7
Max Capacity Contours of Radius(m) Plots 2.1m Dipper
Gradient 1 in -25 Height 2m Lift QH
Locked Rail Cant 150mm - Tandem Lift

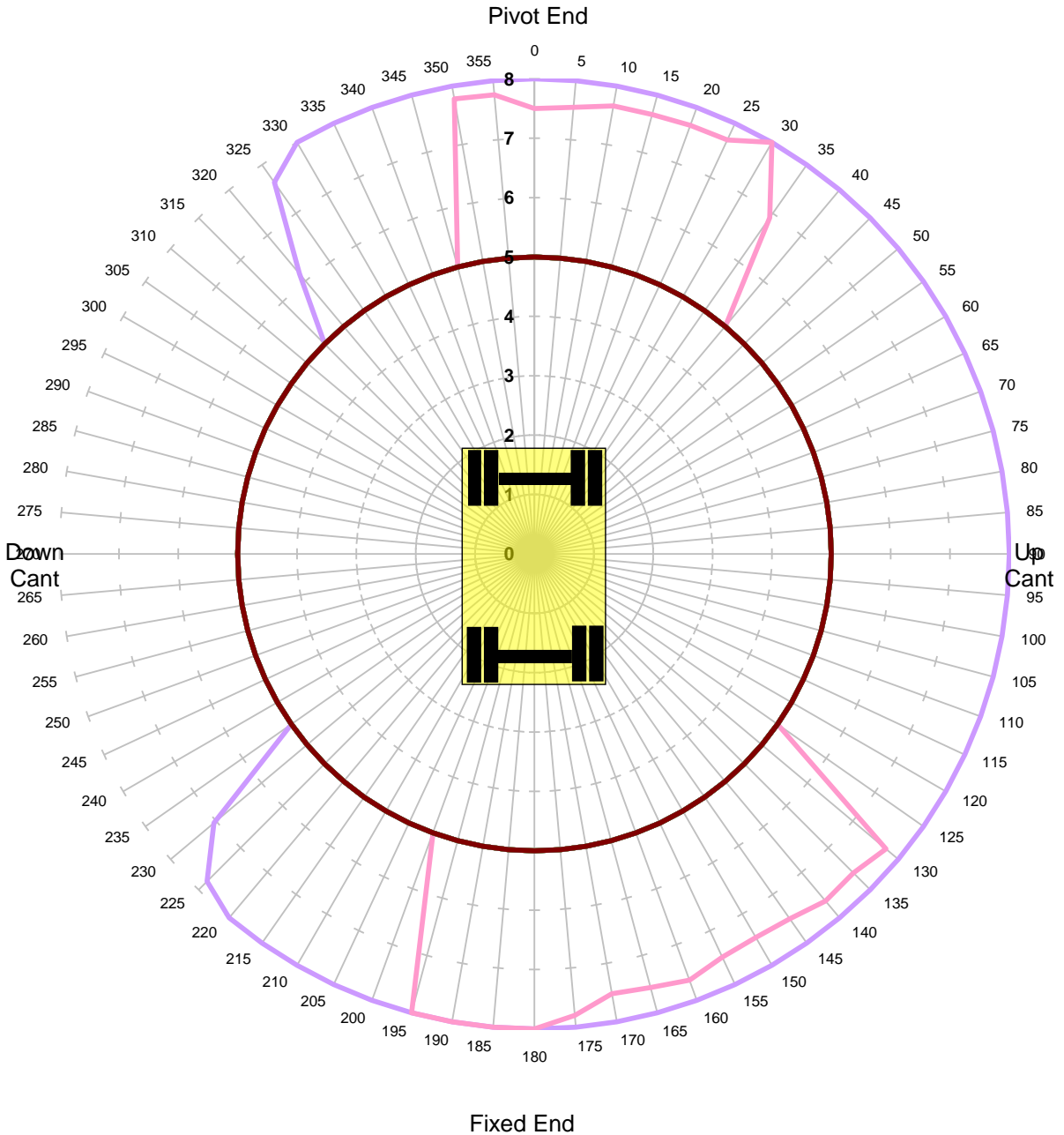

Units in Tonnes

- 1
- 2
- 3
- 4
- 5
- 6
- 7
- 8
- 9
- 10
- 11
- 12
- 13

MACHINE & MODEL:	Komatsu PW160-7	REFERENCE:	REXQUOTE
SERIAL No:	2345	DATE OF CHART:	24-Feb-2022
EQUIPMENT:	5.15m+2.1m	SAFETY FACTOR:	53.0%
COMMENT:			

Komatsu PW160-7
Max Capacity Contours of Radius(m) Plots 2.1m Dipper
Level Ground Height 2m Lift QH
Unlocked Road - Tandem Lift

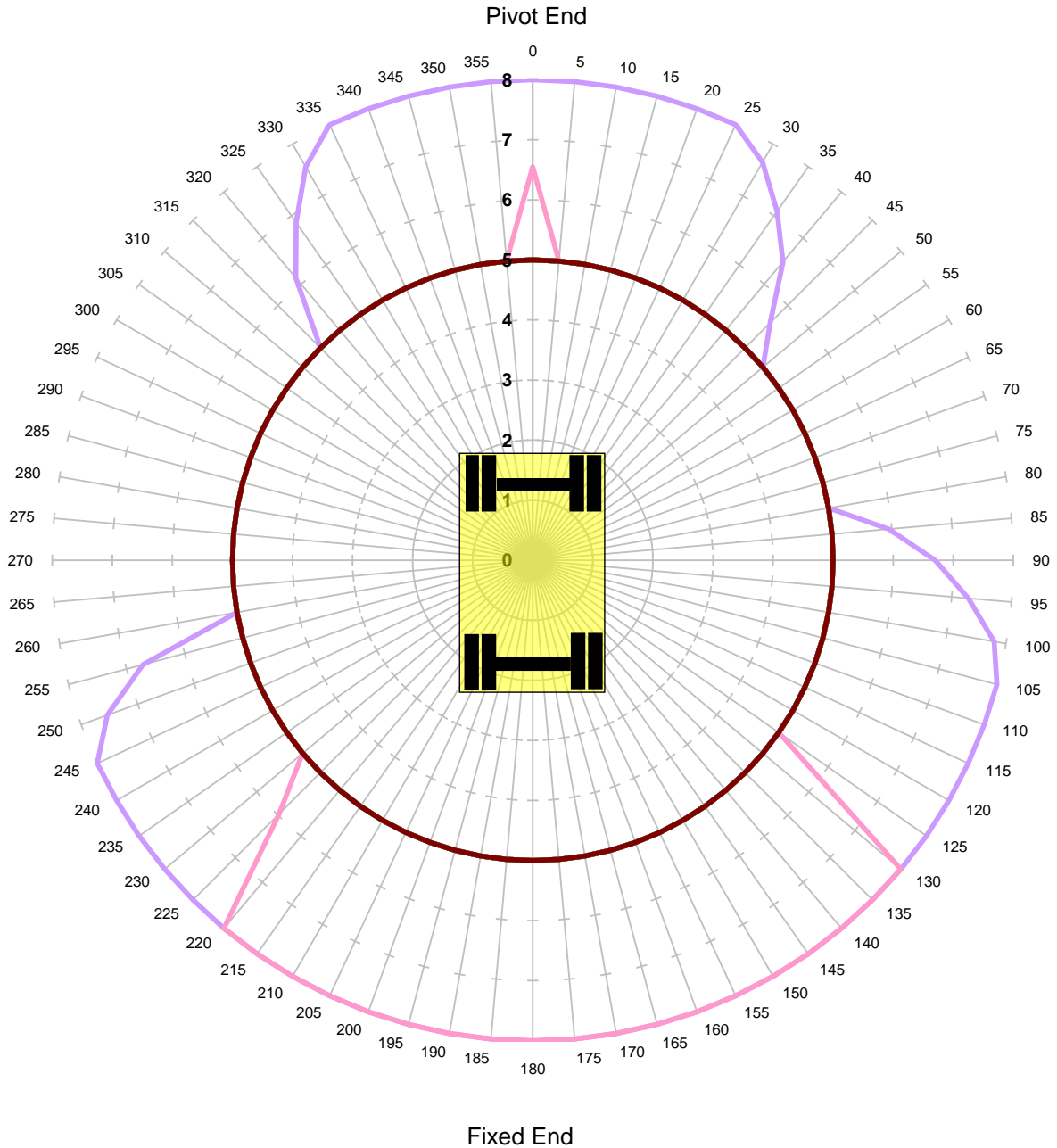

Units in Tonnes

- 1
- 2
- 3
- 4
- 5
- 6
- 7
- 8
- 9
- 10
- 11
- 12
- 13

MACHINE & MODEL:	Komatsu PW160-7	REFERENCE:	REXQUOTE
SERIAL No:	2345	DATE OF CHART:	24-Feb-2022
EQUIPMENT:	5.15m+2.1m	SAFETY FACTOR:	42.0%
COMMENT:			

Komatsu PW160-7
Max Capacity Contours of Radius(m) Plots 2.1m Dipper
Level Ground Height 2m Lift QH
Locked Road - Tandem Lift

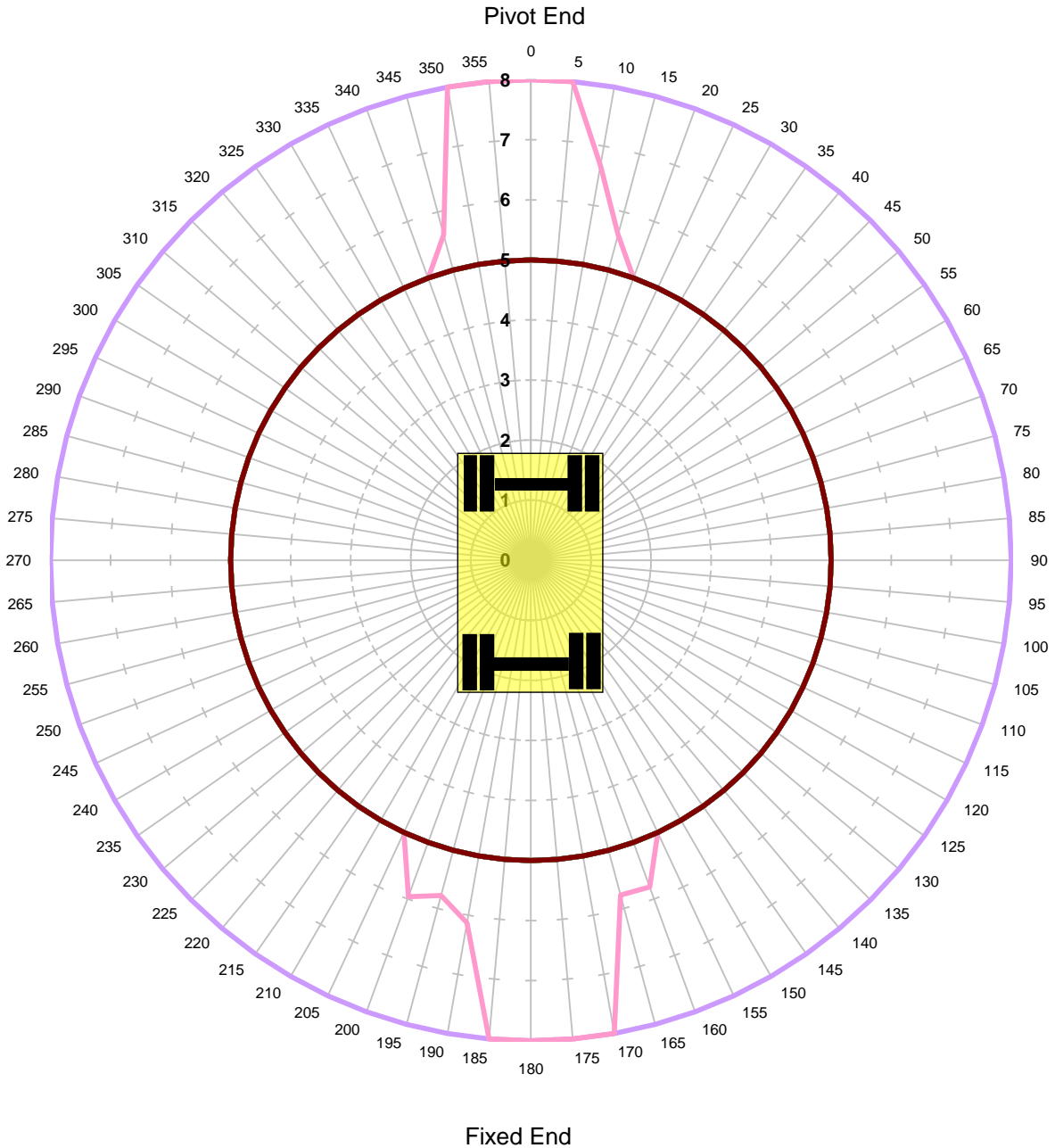

Units in Tonnes

- 1
- 2
- 3
- 4
- 5
- 6
- 7
- 8
- 9
- 10
- 11
- 12
- 13

MACHINE & MODEL:	Komatsu PW160-7	REFERENCE:	REXQUOTE
SERIAL No:	2345	DATE OF CHART:	24-Feb-2022
EQUIPMENT:	5.15m+2.1m	SAFETY FACTOR:	42.0%
COMMENT:			