

MEGARAILER

by REXQUOTE

Broadgauge Business Park
 Bishops Lydeard, Somerset. TA4 3RU
 TEL:01823 433398 FAX:01823 433725
 e-mail: sales@rexquote.co.uk Web: www.rexquote.co.uk

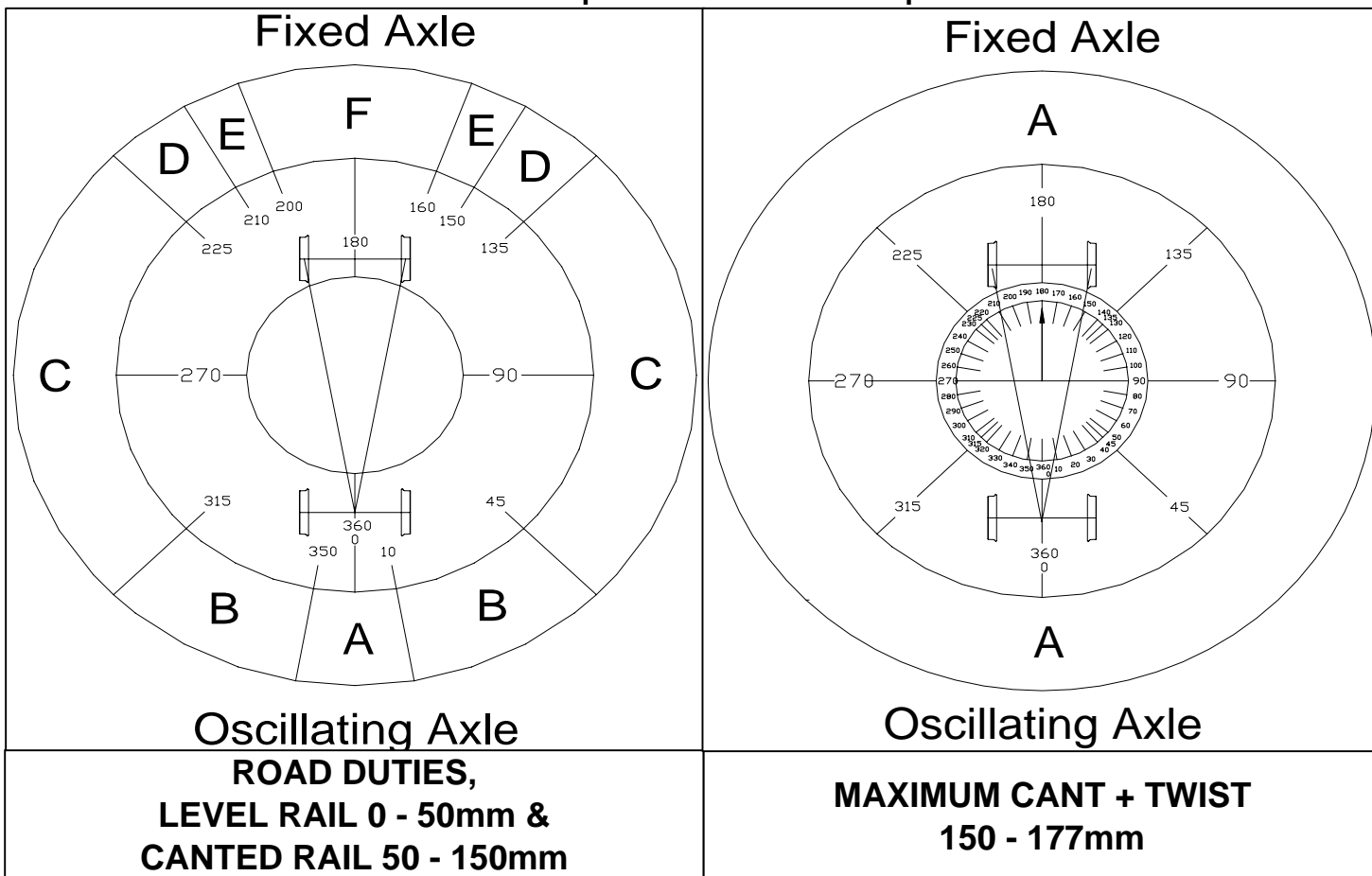

Machine fitted with Standard Arm and Quickhitch

Machine Type:	Komatsu PW160 V04
Serial Number:	H55146
Rail Axle Number:	2305
Equipment:	Boom 5.02m Arm 2.1m
Date:	24 February 2010
Issue:	1
Software Version:	V2.09

This machine is equipped with a Rexquote Rated Capacity Indicator. This system is designed to comply with RAILWAY SAFETY STANDARD RIS-1530-PLT Issue 1

Radius / Height are given in METRES. Loads are given in TONNES, and assume that the load is suspended vertically below the lifting point with no other equipment attached. This machine is fitted with an hydraulically adjustable boom. This allows the machine to reach the same point in space with a variety of different equipment angles, each combination has a different safe working load. The charts above show both the upper & lower limits of the loads achievable. Loads marked 'b' boom, 'r' articulation, and 'a' arm are limited by hydraulic capacity.

All rail duties listed are valid for use on up to a 1:29 gradient, and with a maximum track twist of 27mm.

NETWORK RAIL DUTIES

SECTOR A

Road
Unlocked
75% SWL



	3.0m	3.5m	4.0m	4.5m	5.0m	5.5m	6.0m	6.5m	7.0m	7.5m	8.0m
7.0m	-	-	-	-	-	3.16	-	-	-	-	-
6.0m	-	-	-	-	-	3.17	2.76	2.4	-	-	-
5.0m	-	-	-	-	3.56	3.09	2.71	2.38	2.1	-	-
4.0m	-	-	4.53	3.89	3.38	2.96	2.61	2.31	2.06	1.83	-
3.0m	-	-	-	3.58	3.16	2.79	2.49	2.22	1.99	1.78	-
2.0m	-	-	-	-	2.95	2.64	2.36	2.12	1.91	1.72	1.55
1.0m	-	-	-	-	2.81	2.52	2.26	2.04	1.84	1.67	1.52
0.0m	-	-	-	3.12	2.74	2.44	2.19	1.98	1.8	1.64	-
-1.0m	-	4.35	3.63	3.11	2.72	2.41	2.16	1.95	1.78	-	-
-2.0m	5.43	4.39	3.66	3.14	2.74	2.42	2.17	1.96	-	-	-

Level Rail
0-50mm
67% SWL
Unlocked



	3.0m	3.5m	4.0m	4.5m	5.0m	5.5m	6.0m	6.5m	7.0m	7.5m	8.0m
7.0m	-	-	-	-	-	3.05	-	-	-	-	-
6.0m	-	-	-	-	-	3.04	2.66	2.34	-	-	-
5.0m	-	-	-	-	3.39	2.96	2.61	2.31	2.05	-	-
4.0m	-	-	-	3.68	3.22	2.84	2.52	2.24	2.01	1.8	-
3.0m	-	-	-	3.4	3.02	2.69	2.4	2.16	1.94	1.75	-
2.0m	-	-	-	-	2.85	2.55	2.3	2.07	1.88	1.7	1.54
1.0m	-	-	-	3.09	2.74	2.46	2.22	2.01	1.82	1.66	1.51
0.0m	-	-	-	3.05	2.69	2.4	2.16	1.96	1.78	1.63	-
-1.0m	-	4.21	3.54	3.05	2.68	2.38	2.14	1.94	1.77	-	-
-2.0m	5.21	4.25	3.58	3.08	2.7	2.4	2.16	1.96	-	-	-

Road
Locked
75% SWL



	3.0m	3.5m	4.0m	4.5m	5.0m	5.5m	6.0m	6.5m	7.0m	7.5m	8.0m
7.0m	-	-	-	-	-	3.56	-	-	-	-	-
6.0m	-	-	-	-	-	3.58	3.1	2.69	-	-	-
5.0m	-	-	-	-	4.04	3.49	3.05	2.68	2.35	-	-
4.0m	-	-	5.26	4.47	3.85	3.35	2.94	2.6	2.31	2.05	-
3.0m	-	-	-	4.13	3.61	3.18	2.81	2.5	2.24	2	-
2.0m	-	-	-	-	3.39	3.01	2.68	2.4	2.16	1.94	1.75
1.0m	-	-	-	-	3.24	2.88	2.57	2.31	2.09	1.89	1.71
0.0m	-	-	-	3.63	3.17	2.8	2.5	2.25	2.04	1.85	-
-1.0m	-	5.18	4.26	3.62	3.14	2.77	2.47	2.22	2.01	-	-
-2.0m	6.6	5.23	4.3	3.65	3.16	2.78	2.48	2.23	-	-	-

Level Rail
0-50mm
75% SWL
Locked



	3.0m	3.5m	4.0m	4.5m	5.0m	5.5m	6.0m	6.5m	7.0m	7.5m	8.0m
7.0m	-	-	-	-	-	4.99	-	-	-	-	-
6.0m	-	-	-	-	-	4.98	4.37	3.86	-	-	-
5.0m	-	-	-	-	5.59	4.88	4.31	3.83	3.42	-	-
4.0m	-	-	-	6.2	5.38	4.73	4.2	3.75	3.37	3.03	-
3.0m	-	-	-	5.86	5.14	4.55	4.06	3.65	3.29	2.98	-
2.0m	-	-	-	-	4.94	4.39	3.93	3.55	3.21	2.92	2.67
1.0m	-	-	-	5.47	4.8	4.27	3.83	3.46	3.15	2.87	2.63
0.0m	-	-	-	5.42	4.74	4.21	3.77	3.41	3.1	2.84	-
-1.0m	-	7.65	6.35	5.42	4.73	4.18	3.75	3.39	3.09	-	-
-2.0m	8.39b	7.7	6.39	5.46	4.75	4.2	3.76	3.41	-	-	-

Canted Rail
50-150mm
67% SWL
Unlocked



	3.0m	3.5m	4.0m	4.5m	5.0m	5.5m	6.0m	6.5m	7.0m	7.5m	8.0m
7.0m	-	-	-	-	-	2.42	-	-	-	-	-
6.0m	-	-	-	-	-	2.41	2.08	1.8	-	-	-
5.0m	-	-	-	-	2.7	2.33	2.02	1.77	1.54	-	-
4.0m	-	-	-	2.91	2.52	2.2	1.93	1.7	1.5	1.32	-
3.0m	-	-	-	2.63	2.32	2.05	1.81	1.61	1.43	1.28	-
2.0m	-	-	-	-	2.14	1.91	1.7	1.52	1.37	1.22	1.09
1.0m	-	-	-	2.3	2.03	1.81	1.62	1.45	1.31	1.18	1.06
0.0m	-	-	-	2.26	1.98	1.75	1.57	1.41	1.27	1.15	-
-1.0m	-	3.21	2.66	2.26	1.97	1.73	1.55	1.39	1.26	-	-
-2.0m	4.07	3.25	2.69	2.29	1.99	1.75	1.56	1.4	-	-	-

Max Cant + Twist
150-177mm
67% SWL
Unlocked



	3.0m	3.5m	4.0m	4.5m	5.0m	5.5m	6.0m	6.5m	7.0m	7.5m	8.0m
7.0m	-	-	-	-	-	1.25	-	-	-	-	-
6.0m	-	-	-	-	-	1.24	1.03	0.76	-	-	-
5.0m	-	-	-	-	1.39	1.17	0.96	0.72	0.5	-	-
4.0m	-	-	-	1.44	1.22	1.04	0.82	0.62	0.44	0.27	-
3.0m	-	-	-	1.17	1.03	0.84	0.66	0.49	0.34	0.21	-
2.0m	-	-	-	-	0.79	0.65	0.5	0.37	0.25	0.13	0.02
1.0m	-	-	-	0.79	0.64	0.5	0.38	0.27	0.16	0.07	0
0.0m	-	-	-	0.74	0.56	0.42	0.31	0.2	0.11	0.03	-
-1.0m	-	1.25	0.99	0.73	0.54	0.4	0.28	0.18	0.09	-	-
-2.0m	1.67	1.29	1.04	0.77	0.57	0.42	0.29	0.2	-	-	-

Canted Rail
50-150mm
90% SWL
Locked



	3.0m	3.5m	4.0m	4.5m	5.0m	5.5m	6.0m	6.5m	7.0m	7.5m	8.0m
7.0m	-	-	-	-	-	4.42	-	-	-	-	-
6.0m	-	-	-	-	-	4.4	3.74	3.19	-	-	-
5.0m	-	-	-	-	4.98	4.27	3.65	3.14	2.7	-	-
4.0m	-	-	-	5.49	4.72	4.06	3.5	3.03	2.63	2.28	-
3.0m	-	-	-	5.07	4.41	3.81	3.31	2.89	2.53	2.21	-
2.0m	-	-	-	-	4.13	3.59	3.14	2.75	2.42	2.13	1.87
1.0m	-	-	-	4.58	3.94	3.43	3	2.64	2.33	2.06	1.82
0.0m	-	-	-	4.52	3.86	3.34	2.92	2.56	2.27	2.01	-
-1.0m	-	6.58	5.36	4.52	3.84	3.31	2.88	2.53	2.25	-	-
-2.0m	8.39b	6.64	5.42	4.57	3.87	3.33	2.9	2.56	-	-	-

Max Cant + Twist
150-177mm
75% SWL
Locked



	3.0m	3.5m	4.0m	4.5m	5.0m	5.5m	6.0m	6.5m	7.0m	7.5m	8.0m
7.0m	-	-	-	-	-	1.82	-	-	-	-	-
6.0m	-	-	-	-	-	1.81	1.55	1.26	-	-	-
5.0m	-	-	-	-	2	1.73	1.49	1.22	0.98	-	-
4.0m	-	-	-	2.1	1.83	1.6	1.36	1.12	0.91	0.72	-
3.0m	-	-	-	1.82	1.63	1.43	1.2	1	0.82	0.66	-
2.0m	-	-	-	-	1.44	1.24	1.05	0.89	0.73	0.59	0.46
1.0m	-	-	-	1.5	1.29	1.11	0.94	0.79	0.65	0.53	0.41
0.0m	-	-	-	1.46	1.22	1.03	0.87	0.73	0.6	0.49	-
-1.0m	-	2.06	1.71	1.46	1.2	1	0.84	0.7	0.58	-	-
-2.0m	2.58	2.1	1.75	1.49	1.23	1.02	0.86	0.72	-	-	-

NETWORK RAIL DUTIES

SECTOR B

Road
Unlocked
75% SWL



	3.0m	3.5m	4.0m	4.5m	5.0m	5.5m	6.0m	6.5m	7.0m	7.5m	8.0m
7.0m	-	-	-	-	-	1.85	-	-	-	-	-
6.0m	-	-	-	-	-	1.86	1.57	1.31	-	-	-
5.0m	-	-	-	-	2.11	1.78	1.52	1.29	1.09	-	-
4.0m	-	-	2.66	2.26	1.93	1.65	1.42	1.22	1.05	0.89	-
3.0m	-	-	-	1.94	1.7	1.49	1.29	1.13	0.98	0.84	-
2.0m	-	-	-	-	1.5	1.33	1.17	1.03	0.9	0.79	0.68
1.0m	-	-	-	-	1.36	1.21	1.07	0.95	0.84	0.74	0.64
0.0m	-	-	-	1.48	1.29	1.13	1	0.89	0.79	0.7	-
-1.0m	-	2.16	1.76	1.47	1.27	1.1	0.97	0.86	0.77	-	-
-2.0m	2.81	2.2	1.79	1.5	1.28	1.11	0.98	0.87	-	-	-

Level Rail
0-50mm
67% SWL
Unlocked



	3.0m	3.5m	4.0m	4.5m	5.0m	5.5m	6.0m	6.5m	7.0m	7.5m	8.0m
7.0m	-	-	-	-	-	1.75	-	-	-	-	-
6.0m	-	-	-	-	-	1.75	1.48	1.25	-	-	-
5.0m	-	-	-	-	1.95	1.67	1.42	1.22	1.04	-	-
4.0m	-	-	-	2.07	1.78	1.54	1.33	1.15	0.99	0.77	-
3.0m	-	-	-	-	1.79	1.58	1.39	1.22	1.07	0.89	0.71
2.0m	-	-	-	-	1.41	1.25	1.11	0.96	0.79	0.63	0.49
1.0m	-	-	-	-	1.47	1.3	1.15	1.02	0.86	0.7	0.57
0.0m	-	-	-	1.44	1.25	1.1	0.95	0.79	0.65	0.53	-
-1.0m	-	2.09	1.7	1.43	1.23	1.08	0.92	0.76	0.63	-	-
-2.0m	2.71	2.13	1.74	1.46	1.25	1.09	0.94	0.78	-	-	-

Road
Locked
75% SWL



	3.0m	3.5m	4.0m	4.5m	5.0m	5.5m	6.0m	6.5m	7.0m	7.5m	8.0m
7.0m	-	-	-	-	-	3.42	-	-	-	-	-
6.0m	-	-	-	-	-	3.43	2.95	2.54	-	-	-
5.0m	-	-	-	-	3.91	3.35	2.9	2.53	2.21	-	-
4.0m	-	-	5.15	4.33	3.7	3.2	2.79	2.45	2.16	1.9	-
3.0m	-	-	-	3.98	3.45	3.02	2.65	2.35	2.08	1.85	-
2.0m	-	-	-	-	3.22	2.84	2.52	2.24	2	1.79	1.61
1.0m	-	-	-	-	3.07	2.7	2.4	2.15	1.93	1.74	1.57
0.0m	-	-	-	3.45	2.99	2.63	2.33	2.09	1.88	1.7	-
-1.0m	-	5.05	4.1	3.44	2.96	2.59	2.3	2.06	1.86	-	-
-2.0m	6.58	5.1	4.14	3.47	2.98	2.6	2.3	2.07	-	-	-

Level Rail
0-50mm
90% SWL
Locked



	3.0m	3.5m	4.0m	4.5m	5.0m	5.5m	6.0m	6.5m	7.0m	7.5m	8.0m
7.0m	-	-	-	-	-	3.22	-	-	-	-	-
6.0m	-	-	-	-	-	3.2	2.67	2.22	-	-	-
5.0m	-	-	-	-	3.67	3.07	2.58	2.17	1.82	-	-
4.0m	-	-	-	4.04	3.39	2.87	2.43	2.07	1.75	1.47	-
3.0m	-	-	-	-	3.58	3.07	2.63	2.25	1.93	1.65	1.4
2.0m	-	-	-	-	2.79	2.41	2.08	1.79	1.54	1.32	1.12
1.0m	-	-	-	-	3.05	2.61	2.25	1.94	1.68	1.45	1.25
0.0m	-	-	-	2.99	2.53	2.16	1.86	1.61	1.39	1.21	-
-1.0m	-	4.6	3.65	2.99	2.5	2.13	1.83	1.58	1.37	-	-
-2.0m	5.98	4.66	3.72	3.04	2.54	2.15	1.85	1.6	-	-	-

Canted Rail
50-150mm
67% SWL
Unlocked



	3.0m	3.5m	4.0m	4.5m	5.0m	5.5m	6.0m	6.5m	7.0m	7.5m	8.0m
7.0m	-	-	-	-	-	1.46	-	-	-	-	-
6.0m	-	-	-	-	-	1.45	1.22	1.02	-	-	-
5.0m	-	-	-	-	1.62	1.37	1.16	0.97	0.74	-	-
4.0m	-	-	-	1.69	1.45	1.25	1.07	0.87	0.67	0.49	-
3.0m	-	-	-	1.42	1.26	1.1	0.94	0.75	0.58	0.43	-
2.0m	-	-	-	-	1.09	0.95	0.78	0.63	0.48	0.35	0.23
1.0m	-	-	-	1.12	0.98	0.81	0.66	0.52	0.4	0.29	0.18
0.0m	-	-	-	1.08	0.9	0.73	0.58	0.46	0.35	0.25	-
-1.0m	-	1.59	1.29	1.08	0.88	0.7	0.55	0.43	0.33	-	-
-2.0m	2.06	1.62	1.32	1.11	0.91	0.72	0.57	0.45	-	-	-

Max Cant + Twist
150-177mm
67% SWL
Unlocked



	3.0m	3.5m	4.0m	4.5m	5.0m	5.5m	6.0m	6.5m	7.0m	7.5m	8.0m
7.0m	-	-	-	-	-	1.25	-	-	-	-	-
6.0m	-	-	-	-	-	1.24	1.03	0.76	-	-	-
5.0m	-	-	-	-	1.39	1.17	0.96	0.72	0.5	-	-
4.0m	-	-	-	1.44	1.22	1.04	0.82	0.62	0.44	0.27	-
3.0m	-	-	-	-	1.17	1.03	0.84	0.66	0.49	0.34	0.21
2.0m	-	-	-	-	0.79	0.65	0.5	0.37	0.25	0.13	0.02
1.0m	-	-	-	-	0.79	0.64	0.5	0.38	0.27	0.16	0.07
0.0m	-	-	-	-	0.74	0.56	0.42	0.31	0.2	0.11	0.03
-1.0m	-	1.25	0.99	0.73	0.54	0.4	0.28	0.18	0.09	-	-
-2.0m	1.67	1.29	1.04	0.77	0.57	0.42	0.29	0.2	-	-	-

Canted Rail
50-150mm
90% SWL
Locked



	3.0m	3.5m	4.0m	4.5m	5.0m	5.5m	6.0m	6.5m	7.0m	7.5m	8.0m
7.0m	-	-	-	-	-	2.74	-	-	-	-	-
6.0m	-	-	-	-	-	2.73	2.26	1.86	-	-	-
5.0m	-	-	-	-	3.12	2.61	2.18	1.82	1.51	-	-
4.0m	-	-	-	3.4	2.86	2.41	2.03	1.71	1.44	1.19	-
3.0m	-	-	-	2.97	2.55	2.18	1.86	1.58	1.34	1.12	-
2.0m	-	-	-	-	2.28	1.97	1.69	1.45	1.24	1.04	0.87
1.0m	-	-	-	2.47	2.11	1.82	1.56	1.34	1.15	0.98	0.82
0.0m	-	-	-	2.41	2.03	1.73	1.48	1.27	1.09	0.93	-
-1.0m	-	3.71	2.95	2.41	2.01	1.7	1.45	1.24	1.07	-	-
-2.0m	4.88	3.78	3	2.45	2.04	1.72	1.47	1.27	-	-	-

Max Cant + Twist
150-177mm
75% SWL
Locked



	3.0m	3.5m	4.0m	4.5m	5.0m	5.5m	6.0m	6.5m	7.0m	7.5m	8.0m
7.0m	-	-	-	-	-	1.82	-	-	-	-	-
6.0m	-	-	-	-	-	1.81	1.55	1.26	-	-	-
5.0m	-	-	-	-	2	1.73	1.49	1.22	0.98	-	-
4.0m	-	-	-	2.1	1.83	1.6	1.36	1.12	0.91	0.72	-
3.0m	-	-	-	-	1.82	1.63	1.43	1.2	1	0.82	0.66
2.0m	-	-	-	-	1.44	1.24	1.05	0.89	0.73	0.59	0.46
1.0m	-	-	-	-	1.5	1.29	1.11	0.94	0.79	0.65	0.53
0.0m	-	-	-	-	1.46	1.22	1.03	0.87	0.73	0.6	0.49
-1.0m	-	2.06	1.71	1.46	1.2	1	0.84	0.7	0.58	-	-
-2.0m	2.58	2.1	1.75	1.49	1.23	1.02	0.86	0.72	-	-	-

NETWORK RAIL DUTIES

SECTOR C

Road
Unlocked
75% SWL



	3.0m	3.5m	4.0m	4.5m	5.0m	5.5m	6.0m	6.5m	7.0m	7.5m	8.0m
7.0m	-	-	-	-	-	2.15	-	-	-	-	-
6.0m	-	-	-	-	-	2.17	1.84	1.56	-	-	-
5.0m	-	-	-	-	2.45	2.09	1.8	1.55	1.33	-	-
4.0m	-	-	3.1	2.64	2.26	1.96	1.7	1.48	1.28	1.11	-
3.0m	-	-	-	2.33	2.04	1.79	1.57	1.38	1.21	1.06	-
2.0m	-	-	-	-	1.84	1.63	1.45	1.28	1.14	1.01	0.88
1.0m	-	-	-	-	1.7	1.51	1.35	1.2	1.07	0.95	0.85
0.0m	-	-	-	1.86	1.63	1.44	1.28	1.14	1.02	0.92	-
-1.0m	-	2.67	2.19	1.86	1.61	1.41	1.25	1.12	1	-	-
-2.0m	3.42	2.71	2.23	1.88	1.62	1.42	1.26	1.12	-	-	-

Level Rail
0-50mm
67% SWL
Unlocked



	3.0m	3.5m	4.0m	4.5m	5.0m	5.5m	6.0m	6.5m	7.0m	7.5m	8.0m
7.0m	-	-	-	-	-	1.54	-	-	-	-	-
6.0m	-	-	-	-	-	1.53	1.29	1.08	-	-	-
5.0m	-	-	-	-	1.71	1.45	1.24	1.05	0.83	-	-
4.0m	-	-	-	1.8	1.54	1.33	1.14	0.97	0.76	0.57	-
3.0m	-	-	-	1.52	1.35	1.18	1.03	0.84	0.67	0.51	-
2.0m	-	-	-	-	1.18	1.05	0.89	0.72	0.57	0.43	0.3
1.0m	-	-	-	1.21	1.07	0.92	0.76	0.62	0.49	0.37	0.26
0.0m	-	-	-	1.18	1.02	0.84	0.69	0.55	0.43	0.33	-
-1.0m	-	1.72	1.4	1.18	1.01	0.82	0.66	0.52	0.41	-	-
-2.0m	2.23	1.76	1.44	1.21	1.03	0.84	0.67	0.55	-	-	-

Road
Locked
75% SWL



	3.0m	3.5m	4.0m	4.5m	5.0m	5.5m	6.0m	6.5m	7.0m	7.5m	8.0m
7.0m	-	-	-	-	-	3.37	-	-	-	-	-
6.0m	-	-	-	-	-	3.38	2.91	2.5	-	-	-
5.0m	-	-	-	-	3.85	3.3	2.85	2.48	2.17	-	-
4.0m	-	-	5.08	4.27	3.64	3.15	2.74	2.41	2.12	1.87	-
3.0m	-	-	-	3.91	3.39	2.96	2.61	2.3	2.05	1.82	-
2.0m	-	-	-	-	3.16	2.79	2.47	2.2	1.96	1.76	1.57
1.0m	-	-	-	-	3.01	2.65	2.36	2.11	1.89	1.7	1.53
0.0m	-	-	-	3.38	2.93	2.57	2.29	2.04	1.84	1.66	-
-1.0m	-	4.96	4.02	3.37	2.9	2.54	2.25	2.01	1.82	-	-
-2.0m	6.47	5.01	4.06	3.4	2.92	2.55	2.26	2.02	-	-	-

Level Rail
0-50mm
90% SWL
Locked



	3.0m	3.5m	4.0m	4.5m	5.0m	5.5m	6.0m	6.5m	7.0m	7.5m	8.0m
7.0m	-	-	-	-	-	2.68	-	-	-	-	-
6.0m	-	-	-	-	-	2.66	2.2	1.8	-	-	-
5.0m	-	-	-	-	3.06	2.54	2.12	1.76	1.45	-	-
4.0m	-	-	-	3.33	2.79	2.34	1.97	1.65	1.38	1.13	-
3.0m	-	-	-	2.89	2.47	2.11	1.79	1.52	1.28	1.06	-
2.0m	-	-	-	-	2.2	1.9	1.62	1.39	1.17	0.98	0.81
1.0m	-	-	-	2.38	2.03	1.74	1.49	1.28	1.09	0.92	0.76
0.0m	-	-	-	2.32	1.95	1.66	1.41	1.21	1.03	0.87	-
-1.0m	-	3.62	2.85	2.32	1.93	1.63	1.38	1.18	1.01	-	-
-2.0m	4.8	3.68	2.91	2.37	1.96	1.65	1.4	1.2	-	-	-

Canted Rail
50-150mm
67% SWL
Unlocked



	3.0m	3.5m	4.0m	4.5m	5.0m	5.5m	6.0m	6.5m	7.0m	7.5m	8.0m
7.0m	-	-	-	-	-	1.38	-	-	-	-	-
6.0m	-	-	-	-	-	1.37	1.14	0.91	-	-	-
5.0m	-	-	-	-	1.54	1.29	1.09	0.87	0.64	-	-
4.0m	-	-	-	1.6	1.37	1.17	0.99	0.77	0.57	0.39	-
3.0m	-	-	-	1.33	1.17	1.02	0.82	0.64	0.48	0.33	-
2.0m	-	-	-	-	1	0.82	0.66	0.51	0.38	0.25	0.13
1.0m	-	-	-	1.01	0.84	0.68	0.54	0.41	0.3	0.19	0.09
0.0m	-	-	-	0.96	0.76	0.6	0.46	0.34	0.24	0.15	-
-1.0m	-	1.47	1.18	0.96	0.74	0.57	0.43	0.32	0.22	-	-
-2.0m	1.94	1.51	1.21	1	0.77	0.59	0.45	0.34	-	-	-

Max Cant + Twist
150-177mm
67% SWL
Unlocked



	3.0m	3.5m	4.0m	4.5m	5.0m	5.5m	6.0m	6.5m	7.0m	7.5m	8.0m
7.0m	-	-	-	-	-	1.25	-	-	-	-	-
6.0m	-	-	-	-	-	1.24	1.03	0.76	-	-	-
5.0m	-	-	-	-	1.39	1.17	0.96	0.72	0.5	-	-
4.0m	-	-	-	1.44	1.22	1.04	0.82	0.62	0.44	0.27	-
3.0m	-	-	-	1.17	1.03	0.84	0.66	0.49	0.34	0.21	-
2.0m	-	-	-	-	0.79	0.65	0.5	0.37	0.25	0.13	0.02
1.0m	-	-	-	0.79	0.64	0.5	0.38	0.27	0.16	0.07	0
0.0m	-	-	-	0.74	0.56	0.42	0.31	0.2	0.11	0.03	-
-1.0m	-	1.25	0.99	0.73	0.54	0.4	0.28	0.18	0.09	-	-
-2.0m	1.67	1.29	1.04	0.77	0.57	0.42	0.29	0.2	-	-	-

Canted Rail
50-150mm
90% SWL
Locked



	3.0m	3.5m	4.0m	4.5m	5.0m	5.5m	6.0m	6.5m	7.0m	7.5m	8.0m
7.0m	-	-	-	-	-	2.38	-	-	-	-	-
6.0m	-	-	-	-	-	2.37	1.93	1.55	-	-	-
5.0m	-	-	-	-	2.73	2.24	1.84	1.51	1.21	-	-
4.0m	-	-	-	2.96	2.46	2.04	1.69	1.4	1.14	0.91	-
3.0m	-	-	-	2.52	2.14	1.81	1.52	1.26	1.04	0.84	-
2.0m	-	-	-	-	1.87	1.59	1.35	1.13	0.94	0.76	0.6
1.0m	-	-	-	2	1.7	1.44	1.22	1.02	0.85	0.7	0.56
0.0m	-	-	-	1.95	1.61	1.35	1.13	0.95	0.79	0.65	-
-1.0m	-	3.13	2.43	1.95	1.59	1.32	1.1	0.92	0.77	-	-
-2.0m	4.26	3.19	2.49	1.99	1.62	1.34	1.12	0.95	-	-	-

Max Cant + Twist
150-177mm
75% SWL
Locked



	3.0m	3.5m	4.0m	4.5m	5.0m	5.5m	6.0m	6.5m	7.0m	7.5m	8.0m
7.0m	-	-	-	-	-	1.82	-	-	-	-	-
6.0m	-	-	-	-	-	1.81	1.55	1.26	-	-	-
5.0m	-	-	-	-	2	1.73	1.49	1.22	0.98	-	-
4.0m	-	-	-	2.1	1.83	1.6	1.36	1.12	0.91	0.72	-
3.0m	-	-	-	1.82	1.63	1.43	1.2	1	0.82	0.66	-
2.0m	-	-	-	-	1.44	1.24	1.05	0.89	0.73	0.59	0.46
1.0m	-	-	-	1.5	1.29	1.11	0.94	0.79	0.65	0.53	0.41
0.0m	-	-	-	1.46	1.22	1.03	0.87	0.73	0.6	0.49	-
-1.0m	-	2.06	1.71	1.46	1.2	1	0.84	0.7	0.58	-	-
-2.0m	2.58	2.1	1.75	1.49	1.23	1.02	0.86	0.72	-	-	-

NETWORK RAIL DUTIES

SECTOR D

Road
Unlocked
75% SWL



	3.0m	3.5m	4.0m	4.5m	5.0m	5.5m	6.0m	6.5m	7.0m	7.5m	8.0m
7.0m	-	-	-	-	-	5.09	-	-	-	-	-
6.0m	-	-	-	-	-	5.1	4.48	3.95	-	-	-
5.0m	-	-	-	-	5.75	5.02	4.43	3.94	3.51	-	-
4.0m	-	-	7.5	6.41	5.56	4.88	4.32	3.86	3.47	3.12	-
3.0m	-	-	-	6.07	5.32	4.7	4.19	3.76	3.39	3.07	-
2.0m	-	-	-	-	5.1	4.53	4.06	3.66	3.31	3.01	2.75
1.0m	-	-	-	-	4.95	4.41	3.95	3.57	3.24	2.96	2.71
0.0m	-	-	-	5.57	4.88	4.33	3.88	3.51	3.19	2.92	-
-1.0m	-	7.84	6.51	5.56	4.85	4.3	3.85	3.48	3.17	-	-
-2.0m	8.85b	7.88	6.55	5.59	4.87	4.31	3.86	3.49	-	-	-

Level Rail
0-50mm
67% SWL
Unlocked



	3.0m	3.5m	4.0m	4.5m	5.0m	5.5m	6.0m	6.5m	7.0m	7.5m	8.0m
7.0m	-	-	-	-	-	2.61	-	-	-	-	-
6.0m	-	-	-	-	-	2.6	2.27	1.98	-	-	-
5.0m	-	-	-	-	2.89	2.52	2.21	1.95	1.72	-	-
4.0m	-	-	-	3.12	2.73	2.4	2.12	1.88	1.67	1.49	-
3.0m	-	-	-	2.85	2.53	2.25	2.01	1.8	1.61	1.44	-
2.0m	-	-	-	-	2.37	2.12	1.9	1.71	1.55	1.4	1.26
1.0m	-	-	-	2.54	2.26	2.02	1.82	1.65	1.49	1.35	1.23
0.0m	-	-	-	2.51	2.21	1.97	1.77	1.6	1.45	1.32	-
-1.0m	-	3.47	2.91	2.51	2.2	1.95	1.75	1.58	1.44	-	-
-2.0m	4.31	3.51	2.95	2.53	2.22	1.96	1.76	1.6	-	-	-

Road
Locked
75% SWL



	3.0m	3.5m	4.0m	4.5m	5.0m	5.5m	6.0m	6.5m	7.0m	7.5m	8.0m
7.0m	-	-	-	-	-	5.09	-	-	-	-	-
6.0m	-	-	-	-	-	5.1	4.48	3.95	-	-	-
5.0m	-	-	-	-	5.75	5.02	4.43	3.94	3.51	-	-
4.0m	-	-	7.5	6.41	5.56	4.88	4.32	3.86	3.47	3.12	-
3.0m	-	-	-	6.07	5.32	4.7	4.19	3.76	3.39	3.07	-
2.0m	-	-	-	-	5.1	4.53	4.06	3.66	3.31	3.01	2.75
1.0m	-	-	-	-	4.95	4.41	3.95	3.57	3.24	2.96	2.71
0.0m	-	-	-	5.57	4.88	4.33	3.88	3.51	3.19	2.92	-
-1.0m	-	7.84	6.51	5.56	4.85	4.3	3.85	3.48	3.17	-	-
-2.0m	8.85b	7.88	6.55	5.59	4.87	4.31	3.86	3.49	-	-	-

Level Rail
0-50mm
75% SWL
Locked



	3.0m	3.5m	4.0m	4.5m	5.0m	5.5m	6.0m	6.5m	7.0m	7.5m	8.0m
7.0m	-	-	-	-	-	4.32	-	-	-	-	-
6.0m	-	-	-	-	-	4.31	3.77	3.31	-	-	-
5.0m	-	-	-	-	4.84	4.21	3.7	3.28	2.91	-	-
4.0m	-	-	-	5.34	4.63	4.06	3.59	3.19	2.86	2.56	-
3.0m	-	-	-	5	4.39	3.88	3.45	3.09	2.78	2.51	-
2.0m	-	-	-	-	4.18	3.72	3.33	2.99	2.7	2.45	2.23
1.0m	-	-	-	4.61	4.05	3.6	3.23	2.91	2.64	2.4	2.19
0.0m	-	-	-	4.57	3.99	3.53	3.16	2.86	2.59	2.37	-
-1.0m	-	6.48	5.36	4.57	3.97	3.51	3.14	2.83	2.58	-	-
-2.0m	8.2	6.53	5.41	4.6	4	3.53	3.15	2.85	-	-	-

Canted Rail
50-150mm
67% SWL
Unlocked



	3.0m	3.5m	4.0m	4.5m	5.0m	5.5m	6.0m	6.5m	7.0m	7.5m	8.0m
7.0m	-	-	-	-	-	2.09	-	-	-	-	-
6.0m	-	-	-	-	-	2.08	1.81	1.57	-	-	-
5.0m	-	-	-	-	2.3	2	1.76	1.54	1.35	-	-
4.0m	-	-	-	2.44	2.14	1.89	1.67	1.48	1.31	1.16	-
3.0m	-	-	-	2.19	1.96	1.75	1.56	1.4	1.25	1.12	-
2.0m	-	-	-	-	1.81	1.63	1.47	1.32	1.19	1.07	0.93
1.0m	-	-	-	1.91	1.71	1.54	1.39	1.25	1.14	1.03	0.89
0.0m	-	-	-	1.88	1.66	1.49	1.34	1.21	1.1	0.99	-
-1.0m	-	2.56	2.17	1.88	1.65	1.47	1.32	1.2	1.09	-	-
-2.0m	3.15	2.6	2.2	1.9	1.67	1.48	1.33	1.21	-	-	-

Max Cant + Twist
150-177mm
67% SWL
Unlocked



	3.0m	3.5m	4.0m	4.5m	5.0m	5.5m	6.0m	6.5m	7.0m	7.5m	8.0m
7.0m	-	-	-	-	-	1.25	-	-	-	-	-
6.0m	-	-	-	-	-	1.24	1.03	0.76	-	-	-
5.0m	-	-	-	-	1.39	1.17	0.96	0.72	0.5	-	-
4.0m	-	-	-	1.44	1.22	1.04	0.82	0.62	0.44	0.27	-
3.0m	-	-	-	1.17	1.03	0.84	0.66	0.49	0.34	0.21	-
2.0m	-	-	-	-	0.79	0.65	0.5	0.37	0.25	0.13	0.02
1.0m	-	-	-	0.79	0.64	0.5	0.38	0.27	0.16	0.07	0
0.0m	-	-	-	0.74	0.56	0.42	0.31	0.2	0.11	0.03	-
-1.0m	-	1.25	0.99	0.73	0.54	0.4	0.28	0.18	0.09	-	-
-2.0m	1.67	1.29	1.04	0.77	0.57	0.42	0.29	0.2	-	-	-

Canted Rail
50-150mm
75% SWL
Locked



	3.0m	3.5m	4.0m	4.5m	5.0m	5.5m	6.0m	6.5m	7.0m	7.5m	8.0m
7.0m	-	-	-	-	-	3.94	-	-	-	-	-
6.0m	-	-	-	-	-	3.93	3.44	3.02	-	-	-
5.0m	-	-	-	-	4.4	3.84	3.38	2.99	2.65	-	-
4.0m	-	-	-	4.82	4.2	3.69	3.27	2.91	2.6	2.33	-
3.0m	-	-	-	4.5	3.97	3.52	3.14	2.81	2.53	2.28	-
2.0m	-	-	-	-	3.77	3.36	3.01	2.71	2.45	2.22	2.02
1.0m	-	-	-	4.12	3.64	3.24	2.91	2.63	2.39	2.17	1.98
0.0m	-	-	-	4.08	3.58	3.18	2.85	2.58	2.34	2.14	-
-1.0m	-	5.72	4.77	4.08	3.56	3.16	2.83	2.56	2.33	-	-
-2.0m	7.17	5.77	4.81	4.11	3.59	3.17	2.84	2.58	-	-	-

Max Cant + Twist
150-177mm
75% SWL
Locked



	3.0m	3.5m	4.0m	4.5m	5.0m	5.5m	6.0m	6.5m	7.0m	7.5m	8.0m
7.0m	-	-	-	-	-	1.82	-	-	-	-	-
6.0m	-	-	-	-	-	1.81	1.55	1.26	-	-	-
5.0m	-	-	-	-	2	1.73	1.49	1.22	0.98	-	-
4.0m	-	-	-	2.1	1.83	1.6	1.36	1.12	0.91	0.72	-
3.0m	-	-	-	1.82	1.63	1.43	1.2	1	0.82	0.66	-
2.0m	-	-	-	-	1.44	1.24	1.05	0.89	0.73	0.59	0.46
1.0m	-	-	-	1.5	1.29	1.11	0.94	0.79	0.65	0.53	0.41
0.0m	-	-	-	1.46	1.22	1.03	0.87	0.73	0.6	0.49	-
-1.0m	-	2.06	1.71	1.46	1.2	1	0.84	0.7	0.58	-	-
-2.0m	2.58	2.1	1.75	1.49	1.23	1.02	0.86	0.72	-	-	-

NETWORK RAIL DUTIES

SECTOR E

Road
Unlocked
75% SWL



	3.0m	3.5m	4.0m	4.5m	5.0m	5.5m	6.0m	6.5m	7.0m	7.5m	8.0m
7.0m	-	-	-	-	-	5.09	-	-	-	-	-
6.0m	-	-	-	-	-	5.1	4.48	3.95	-	-	-
5.0m	-	-	-	-	5.75	5.02	4.43	3.94	3.51	-	-
4.0m	-	-	7.5	6.41	5.56	4.88	4.32	3.86	3.47	3.12	-
3.0m	-	-	-	6.07	5.32	4.7	4.19	3.76	3.39	3.07	-
2.0m	-	-	-	-	5.1	4.53	4.06	3.66	3.31	3.01	2.75
1.0m	-	-	-	-	4.95	4.41	3.95	3.57	3.24	2.96	2.71
0.0m	-	-	-	5.57	4.88	4.33	3.88	3.51	3.19	2.92	-
-1.0m	-	7.84	6.51	5.56	4.85	4.3	3.85	3.48	3.17	-	-
-2.0m	8.84b	7.88	6.55	5.59	4.87	4.31	3.86	3.49	-	-	-

Level Rail
0-50mm
67% SWL
Unlocked



	3.0m	3.5m	4.0m	4.5m	5.0m	5.5m	6.0m	6.5m	7.0m	7.5m	8.0m
7.0m	-	-	-	-	-	3.81	-	-	-	-	-
6.0m	-	-	-	-	-	3.8	3.38	3.03	-	-	-
5.0m	-	-	-	-	4.19	3.73	3.33	3	2.71	-	-
4.0m	-	-	-	4.55	4.04	3.61	3.25	2.94	2.66	2.42	-
3.0m	-	-	-	4.3	3.86	3.47	3.14	2.86	2.6	2.38	-
2.0m	-	-	-	-	3.7	3.35	3.04	2.78	2.54	2.33	2.14
1.0m	-	-	-	4.01	3.6	3.26	2.97	2.71	2.49	2.29	2.11
0.0m	-	-	-	3.98	3.56	3.21	2.92	2.67	2.45	2.26	-
-1.0m	-	5.27	4.53	3.98	3.54	3.19	2.9	2.65	2.44	-	-
-2.0m	6.31	5.31	4.57	4	3.56	3.2	2.91	2.67	-	-	-

Road
Locked
75% SWL



	3.0m	3.5m	4.0m	4.5m	5.0m	5.5m	6.0m	6.5m	7.0m	7.5m	8.0m
7.0m	-	-	-	-	-	5.09	-	-	-	-	-
6.0m	-	-	-	-	-	5.1	4.48	3.95	-	-	-
5.0m	-	-	-	-	5.75	5.02	4.43	3.94	3.51	-	-
4.0m	-	-	7.5	6.41	5.56	4.88	4.32	3.86	3.47	3.12	-
3.0m	-	-	-	6.07	5.32	4.7	4.19	3.76	3.39	3.07	-
2.0m	-	-	-	-	5.1	4.53	4.06	3.66	3.31	3.01	2.75
1.0m	-	-	-	-	4.95	4.41	3.95	3.57	3.24	2.96	2.71
0.0m	-	-	-	5.57	4.88	4.33	3.88	3.51	3.19	2.92	-
-1.0m	-	7.84	6.51	5.56	4.85	4.3	3.85	3.48	3.17	-	-
-2.0m	8.84b	7.88	6.55	5.59	4.87	4.31	3.86	3.49	-	-	-

Level Rail
0-50mm
75% SWL
Locked



	3.0m	3.5m	4.0m	4.5m	5.0m	5.5m	6.0m	6.5m	7.0m	7.5m	8.0m
7.0m	-	-	-	-	-	5.21	-	-	-	-	-
6.0m	-	-	-	-	-	5.2	4.6	4.09	-	-	-
5.0m	-	-	-	-	5.81	5.11	4.53	4.05	3.64	-	-
4.0m	-	-	-	6.41	5.61	4.96	4.43	3.97	3.59	3.25	-
3.0m	-	-	-	6.09	5.38	4.79	4.3	3.88	3.51	3.2	-
2.0m	-	-	-	-	5.18	4.64	4.17	3.78	3.44	3.14	2.87
1.0m	-	-	-	5.72	5.06	4.52	4.08	3.7	3.37	3.09	2.84
0.0m	-	-	-	5.68	5	4.46	4.02	3.65	3.33	3.06	-
-1.0m	-	7.84	6.59	5.68	4.98	4.44	3.99	3.63	3.32	-	-
-2.0m	8.46b	7.89	6.63	5.71	5.01	4.45	4.01	3.64	-	-	-

Canted Rail
50-150mm
67% SWL
Unlocked



	3.0m	3.5m	4.0m	4.5m	5.0m	5.5m	6.0m	6.5m	7.0m	7.5m	8.0m
7.0m	-	-	-	-	-	3.18	-	-	-	-	-
6.0m	-	-	-	-	-	3.17	2.79	2.46	-	-	-
5.0m	-	-	-	-	3.53	3.09	2.73	2.43	2.16	-	-
4.0m	-	-	-	3.83	3.36	2.97	2.64	2.36	2.12	1.9	-
3.0m	-	-	-	3.56	3.17	2.83	2.53	2.28	2.05	1.86	-
2.0m	-	-	-	-	3	2.69	2.43	2.19	1.99	1.81	1.64
1.0m	-	-	-	3.25	2.89	2.6	2.34	2.13	1.93	1.76	1.61
0.0m	-	-	-	3.22	2.84	2.54	2.29	2.08	1.9	1.74	-
-1.0m	-	4.41	3.72	3.22	2.83	2.52	2.27	2.06	1.88	-	-
-2.0m	5.43	4.45	3.76	3.24	2.85	2.54	2.28	2.08	-	-	-

Max Cant + Twist
150-177mm
67% SWL
Unlocked



	3.0m	3.5m	4.0m	4.5m	5.0m	5.5m	6.0m	6.5m	7.0m	7.5m	8.0m
7.0m	-	-	-	-	-	1.25	-	-	-	-	-
6.0m	-	-	-	-	-	1.24	1.03	0.76	-	-	-
5.0m	-	-	-	-	1.39	1.17	0.96	0.72	0.5	-	-
4.0m	-	-	-	1.44	1.22	1.04	0.82	0.62	0.44	0.27	-
3.0m	-	-	-	1.17	1.03	0.84	0.66	0.49	0.34	0.21	-
2.0m	-	-	-	-	0.79	0.65	0.5	0.37	0.25	0.13	0.02
1.0m	-	-	-	0.79	0.64	0.5	0.38	0.27	0.16	0.07	0
0.0m	-	-	-	0.74	0.56	0.42	0.31	0.2	0.11	0.03	-
-1.0m	-	1.25	0.99	0.73	0.54	0.4	0.28	0.18	0.09	-	-
-2.0m	1.67	1.29	1.04	0.77	0.57	0.42	0.29	0.2	-	-	-

Canted Rail
50-150mm
75% SWL
Locked



	3.0m	3.5m	4.0m	4.5m	5.0m	5.5m	6.0m	6.5m	7.0m	7.5m	8.0m
7.0m	-	-	-	-	-	4.4	-	-	-	-	-
6.0m	-	-	-	-	-	4.39	3.86	3.42	-	-	-
5.0m	-	-	-	-	4.91	4.3	3.8	3.38	3.02	-	-
4.0m	-	-	-	5.4	4.71	4.16	3.69	3.3	2.97	2.67	-
3.0m	-	-	-	5.07	4.48	3.98	3.56	3.21	2.9	2.62	-
2.0m	-	-	-	-	4.28	3.83	3.44	3.11	2.82	2.57	2.34
1.0m	-	-	-	4.7	4.16	3.72	3.34	3.03	2.76	2.52	2.31
0.0m	-	-	-	4.66	4.1	3.65	3.29	2.98	2.71	2.48	-
-1.0m	-	6.48	5.42	4.66	4.09	3.63	3.26	2.96	2.7	-	-
-2.0m	8.05	6.52	5.47	4.69	4.11	3.65	3.28	2.97	-	-	-

Max Cant + Twist
150-177mm
75% SWL
Locked



	3.0m	3.5m	4.0m	4.5m	5.0m	5.5m	6.0m	6.5m	7.0m	7.5m	8.0m
7.0m	-	-	-	-	-	1.82	-	-	-	-	-
6.0m	-	-	-	-	-	1.81	1.55	1.26	-	-	-
5.0m	-	-	-	-	2	1.73	1.49	1.22	0.98	-	-
4.0m	-	-	-	2.1	1.83	1.6	1.36	1.12	0.91	0.72	-
3.0m	-	-	-	1.82	1.63	1.43	1.2	1	0.82	0.66	-
2.0m	-	-	-	-	1.44	1.24	1.05	0.89	0.73	0.59	0.46
1.0m	-	-	-	1.5	1.29	1.11	0.94	0.79	0.65	0.53	0.41
0.0m	-	-	-	1.46	1.22	1.03	0.87	0.73	0.6	0.49	-
-1.0m	-	2.06	1.71	1.46	1.2	1	0.84	0.7	0.58	-	-
-2.0m	2.58	2.1	1.75	1.49	1.23	1.02	0.86	0.72	-	-	-

NETWORK RAIL DUTIES

SECTOR F

Road
Unlocked
75% SWL



	3.0m	3.5m	4.0m	4.5m	5.0m	5.5m	6.0m	6.5m	7.0m	7.5m	8.0m
7.0m	-	-	-	-	-	5.09	-	-	-	-	-
6.0m	-	-	-	-	-	5.1	4.48	3.95	-	-	-
5.0m	-	-	-	-	5.75	5.02	4.43	3.94	3.51	-	-
4.0m	-	-	7.5	6.41	5.56	4.88	4.32	3.86	3.47	3.12	-
3.0m	-	-	-	6.07	5.32	4.7	4.19	3.76	3.39	3.07	-
2.0m	-	-	-	-	5.1	4.53	4.06	3.66	3.31	3.01	2.75
1.0m	-	-	-	-	4.95	4.41	3.95	3.57	3.24	2.96	2.71
0.0m	-	-	-	5.57	4.88	4.33	3.88	3.51	3.19	2.92	-
-1.0m	-	7.84	6.51	5.56	4.85	4.3	3.85	3.48	3.17	-	-
-2.0m	8.82b	7.88	6.55	5.59	4.87	4.31	3.86	3.49	-	-	-

Level Rail
0-50mm
67% SWL
Unlocked



	3.0m	3.5m	4.0m	4.5m	5.0m	5.5m	6.0m	6.5m	7.0m	7.5m	8.0m
7.0m	-	-	-	-	-	4.59	-	-	-	-	-
6.0m	-	-	-	-	-	4.58	4.05	3.6	-	-	-
5.0m	-	-	-	-	5.12	4.5	3.99	3.57	3.2	-	-
4.0m	-	-	-	5.65	4.94	4.37	3.9	3.5	3.16	2.86	-
3.0m	-	-	-	5.36	4.74	4.22	3.78	3.41	3.09	2.81	-
2.0m	-	-	-	-	4.56	4.08	3.67	3.32	3.02	2.76	2.53
1.0m	-	-	-	5.03	4.45	3.98	3.58	3.25	2.96	2.72	2.49
0.0m	-	-	-	4.99	4.4	3.92	3.53	3.21	2.93	2.69	-
-1.0m	-	6.9	5.79	4.99	4.38	3.9	3.51	3.19	2.91	-	-
-2.0m	8.46b	6.94	5.83	5.02	4.4	3.92	3.52	3.2	-	-	-

Road
Locked
75% SWL



	3.0m	3.5m	4.0m	4.5m	5.0m	5.5m	6.0m	6.5m	7.0m	7.5m	8.0m
7.0m	-	-	-	-	-	5.09	-	-	-	-	-
6.0m	-	-	-	-	-	5.1	4.48	3.95	-	-	-
5.0m	-	-	-	-	5.75	5.02	4.43	3.94	3.51	-	-
4.0m	-	-	7.5	6.41	5.56	4.88	4.32	3.86	3.47	3.12	-
3.0m	-	-	-	6.07	5.32	4.7	4.19	3.76	3.39	3.07	-
2.0m	-	-	-	-	5.1	4.53	4.06	3.66	3.31	3.01	2.75
1.0m	-	-	-	-	4.95	4.41	3.95	3.57	3.24	2.96	2.71
0.0m	-	-	-	5.57	4.88	4.33	3.88	3.51	3.19	2.92	-
-1.0m	-	7.84	6.51	5.56	4.85	4.3	3.85	3.48	3.17	-	-
-2.0m	8.81b	7.88	6.55	5.59	4.87	4.31	3.86	3.49	-	-	-

Level Rail
0-50mm
75% SWL
Locked



	3.0m	3.5m	4.0m	4.5m	5.0m	5.5m	6.0m	6.5m	7.0m	7.5m	8.0m
7.0m	-	-	-	-	-	5.23	-	-	-	-	-
6.0m	-	-	-	-	-	5.22	4.61	4.1	-	-	-
5.0m	-	-	-	-	5.83	5.13	4.55	4.07	3.65	-	-
4.0m	-	-	-	6.43	5.63	4.98	4.44	3.99	3.6	3.26	-
3.0m	-	-	-	6.11	5.4	4.81	4.31	3.89	3.53	3.21	-
2.0m	-	-	-	-	5.2	4.65	4.19	3.79	3.45	3.15	2.88
1.0m	-	-	-	5.74	5.08	4.54	4.09	3.71	3.39	3.1	2.85
0.0m	-	-	-	5.7	5.02	4.48	4.03	3.66	3.34	3.07	-
-1.0m	-	7.87	6.61	5.7	5	4.45	4.01	3.64	3.33	-	-
-2.0m	8.45b	7.92	6.65	5.73	5.02	4.47	4.02	3.66	-	-	-

Canted Rail
50-150mm
67% SWL
Unlocked



	3.0m	3.5m	4.0m	4.5m	5.0m	5.5m	6.0m	6.5m	7.0m	7.5m	8.0m
7.0m	-	-	-	-	-	4.21	-	-	-	-	-
6.0m	-	-	-	-	-	4.2	3.76	3.37	-	-	-
5.0m	-	-	-	-	4.64	4.13	3.71	3.34	3.02	-	-
4.0m	-	-	-	5.04	4.48	4.02	3.62	3.28	2.98	2.72	-
3.0m	-	-	-	4.79	4.3	3.88	3.51	3.2	2.92	2.68	-
2.0m	-	-	-	-	4.15	3.75	3.42	3.12	2.86	2.63	2.42
1.0m	-	-	-	4.51	4.05	3.67	3.34	3.05	2.81	2.59	2.39
0.0m	-	-	-	4.48	4	3.62	3.29	3.01	2.77	2.56	-
-1.0m	-	5.91	5.09	4.47	3.99	3.6	3.27	3	2.76	-	-
-2.0m	7.05	5.94	5.12	4.5	4.01	3.61	3.28	3.01	-	-	-

Max Cant + Twist
150-177mm
67% SWL
Unlocked



	3.0m	3.5m	4.0m	4.5m	5.0m	5.5m	6.0m	6.5m	7.0m	7.5m	8.0m
7.0m	-	-	-	-	-	1.25	-	-	-	-	-
6.0m	-	-	-	-	-	1.24	1.03	0.76	-	-	-
5.0m	-	-	-	-	1.39	1.17	0.96	0.72	0.5	-	-
4.0m	-	-	-	1.44	1.22	1.04	0.82	0.62	0.44	0.27	-
3.0m	-	-	-	1.17	1.03	0.84	0.66	0.49	0.34	0.21	-
2.0m	-	-	-	-	0.79	0.65	0.5	0.37	0.25	0.13	0.02
1.0m	-	-	-	0.79	0.64	0.5	0.38	0.27	0.16	0.07	0
0.0m	-	-	-	0.74	0.56	0.42	0.31	0.2	0.11	0.03	-
-1.0m	-	1.25	0.99	0.73	0.54	0.4	0.28	0.18	0.09	-	-
-2.0m	1.67	1.29	1.04	0.77	0.57	0.42	0.29	0.2	-	-	-

Canted Rail
50-150mm
75% SWL
Locked



	3.0m	3.5m	4.0m	4.5m	5.0m	5.5m	6.0m	6.5m	7.0m	7.5m	8.0m
7.0m	-	-	-	-	-	5.23	-	-	-	-	-
6.0m	-	-	-	-	-	5.22	4.61	4.1	-	-	-
5.0m	-	-	-	-	5.83	5.13	4.55	4.07	3.65	-	-
4.0m	-	-	-	6.43	5.63	4.98	4.44	3.99	3.6	3.26	-
3.0m	-	-	-	6.11	5.4	4.81	4.31	3.89	3.53	3.21	-
2.0m	-	-	-	-	5.2	4.65	4.19	3.79	3.45	3.15	2.88
1.0m	-	-	-	5.74	5.08	4.54	4.09	3.71	3.39	3.1	2.85
0.0m	-	-	-	5.7	5.02	4.48	4.03	3.66	3.34	3.07	-
-1.0m	-	7.87	6.61	5.7	5	4.45	4.01	3.64	3.33	-	-
-2.0m	8.33b	7.92	6.65	5.73	5.02	4.47	4.02	3.66	-	-	-

Max Cant + Twist
150-177mm
75% SWL
Locked



	3.0m	3.5m	4.0m	4.5m	5.0m	5.5m	6.0m	6.5m	7.0m	7.5m	8.0m
7.0m	-	-	-	-	-	1.82	-	-	-	-	-
6.0m	-	-	-	-	-	1.81	1.55	1.26	-	-	-
5.0m	-	-	-	-	2	1.73	1.49	1.22	0.98	-	-
4.0m	-	-	-	2.1	1.83	1.6	1.36	1.12	0.91	0.72	-
3.0m	-	-	-	1.82	1.63	1.43	1.2	1	0.82	0.66	-
2.0m	-	-	-	-	1.44	1.24	1.05	0.89	0.73	0.59	0.46
1.0m	-	-	-	1.5	1.29	1.11	0.94	0.79	0.65	0.53	0.41
0.0m	-	-	-	1.46	1.22	1.03	0.87	0.73	0.6	0.49	-
-1.0m	-	2.06	1.71	1.46	1.2	1	0.84	0.7	0.58	-	-
-2.0m	2.58	2.1	1.75	1.49	1.23	1.02	0.86	0.72	-	-	-