

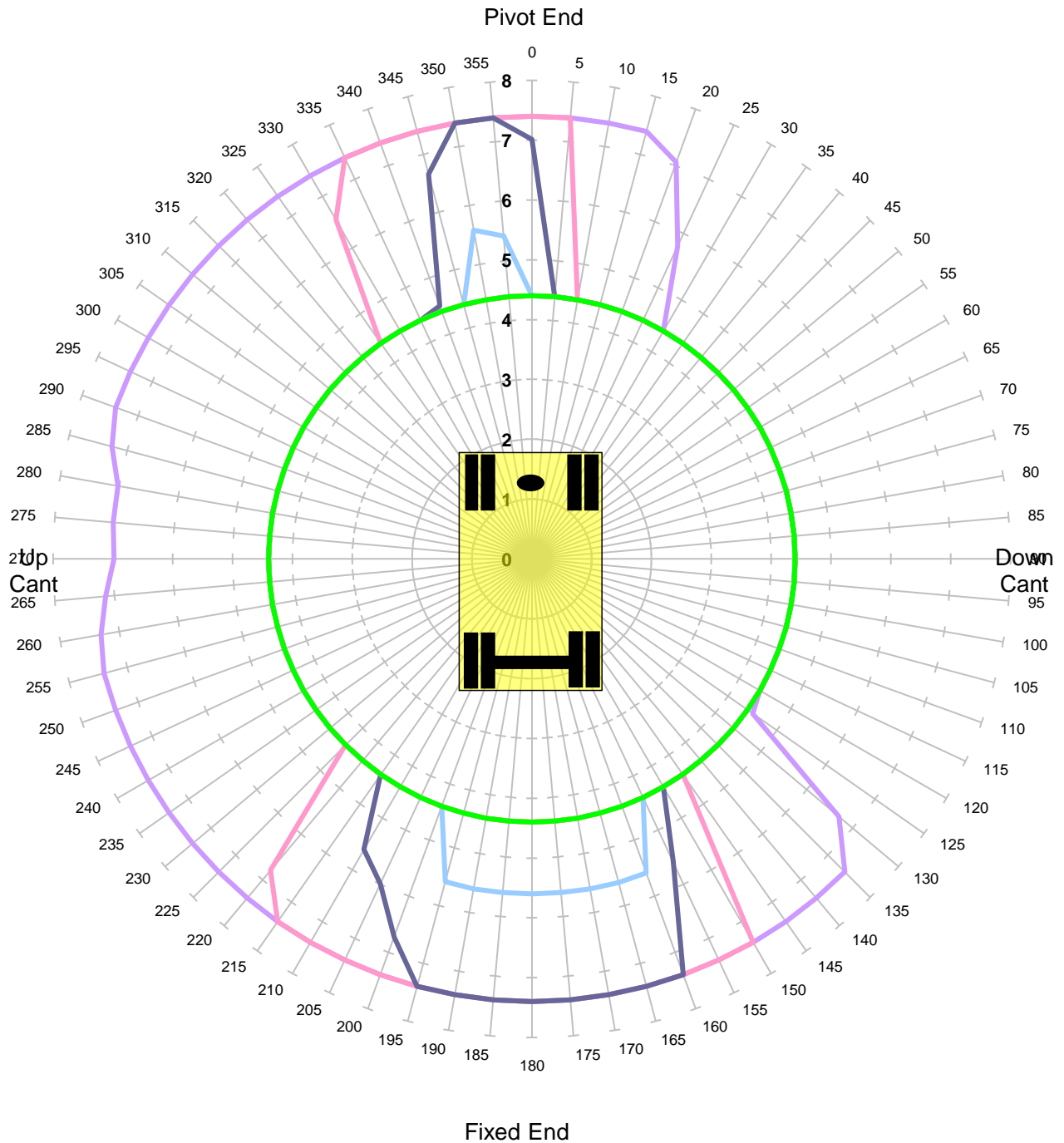

KING TRANSPORT EQUIPMENT LTD

**Max Capacity Contours of Radius(m) Plots 2.1m Dipper
Gradient 1 in -25 Height 2m Lift BP**

Unlocked Rail Cant -150mm



Units in Tonnes

- 1
- 2
- 3
- 4
- 5
- 6
- 7

MACHINE & MODEL:	Komatsu PW160	REFERENCE:	
SERIAL No:	H55147	DATE OF CHART:	23-Jul-2020
EQUIPMENT:	5.15m + 2.10m	SAFETY FACTOR:	67.0%
COMMENT:			



KING TRANSPORT EQUIPMENT LTD

**Max Capacity Contours of Radius(m) Plots 2.1m Dipper
Gradient 1 in -25 Height 2m Lift BP**

Unlocked Rail Cant -50mm

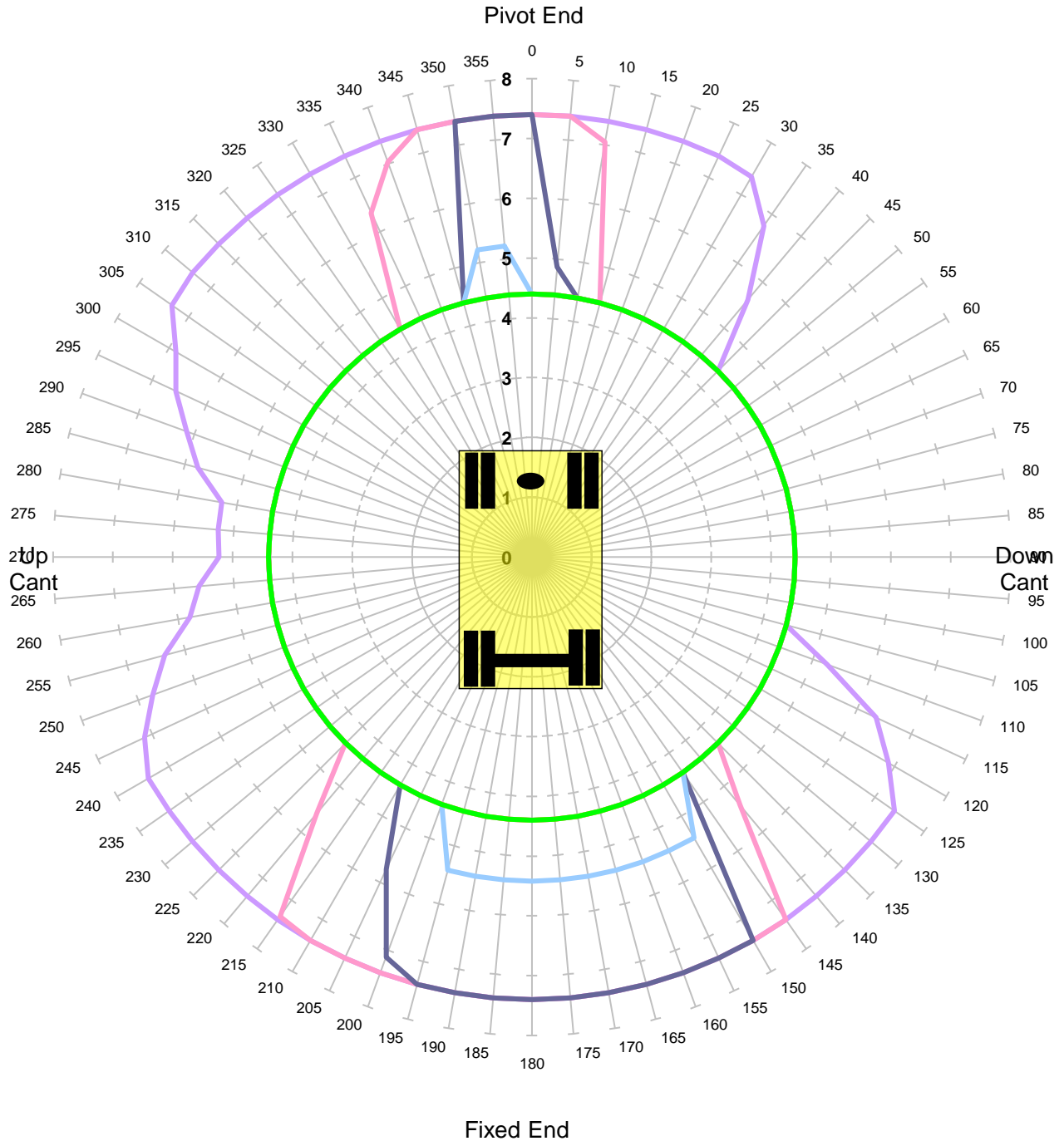

Units in Tonnes

- 1
- 2
- 3
- 4
- 5
- 6
- 7

MACHINE & MODEL:	Komatsu PW160	REFERENCE:	
SERIAL No:	H55147	DATE OF CHART:	23-Jul-2020
EQUIPMENT:	5.15m + 2.10m	SAFETY FACTOR:	67.0%
COMMENT:			



KING TRANSPORT EQUIPMENT LTD

**Max Capacity Contours of Radius(m) Plots 2.1m Dipper
Gradient 1 in -25 Height 2m Lift BP**

Unlocked Rail Cant 50mm

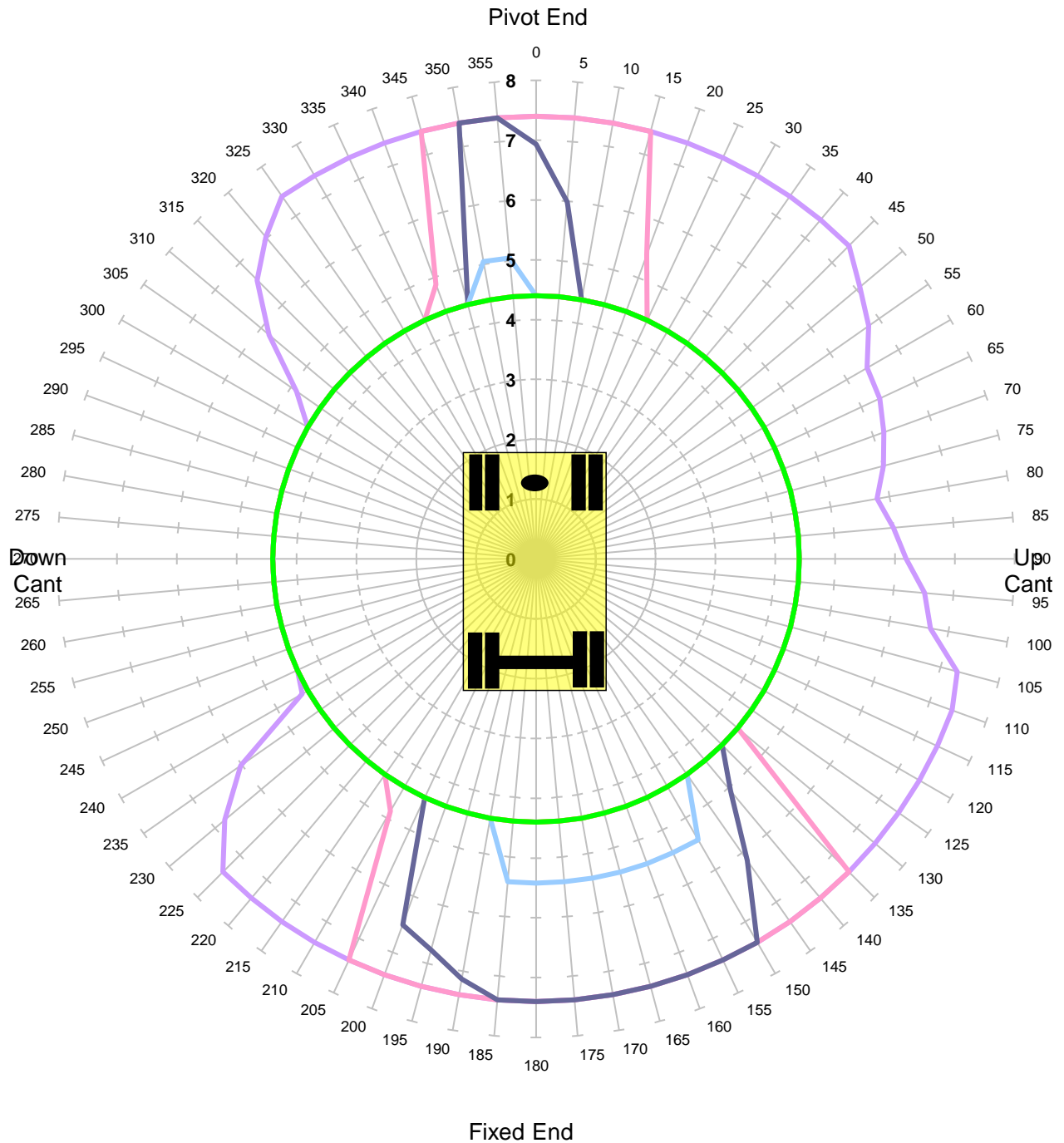

Units in Tonnes

- 1
- 2
- 3
- 4
- 5
- 6
- 7

MACHINE & MODEL: SERIAL No: EQUIPMENT: COMMENT:	Komatsu PW160 H55147 5.15m + 2.10m	REFERENCE: DATE OF CHART: SAFETY FACTOR:	23-Jul-2020 67.0%



KING TRANSPORT EQUIPMENT LTD

**Max Capacity Contours of Radius(m) Plots 2.1m Dipper
Gradient 1 in -25 Height 2m Lift BP**

Unlocked Rail Cant 150mm

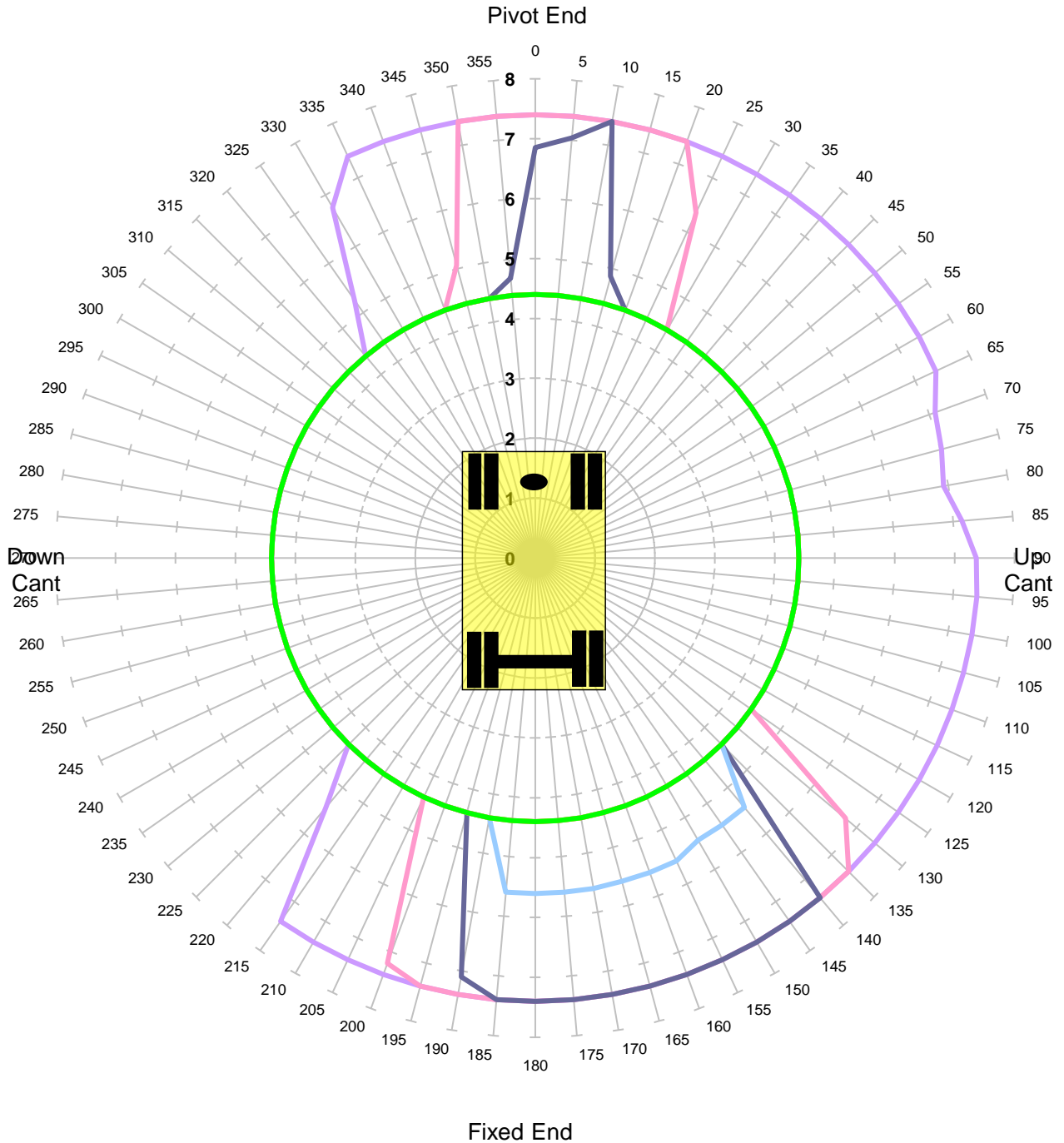

Units in Tonnes

- 1
- 2
- 3
- 4
- 5
- 6
- 7

MACHINE & MODEL:	Komatsu PW160	REFERENCE:	
SERIAL No:	H55147	DATE OF CHART:	23-Jul-2020
EQUIPMENT:	5.15m + 2.10m	SAFETY FACTOR:	67.0%
COMMENT:			



KING TRANSPORT EQUIPMENT LTD

**Max Capacity Contours of Radius(m) Plots 2.1m Dipper
Gradient 1 in -25 Height 2m Lift BP**

Locked Rail Cant -150mm

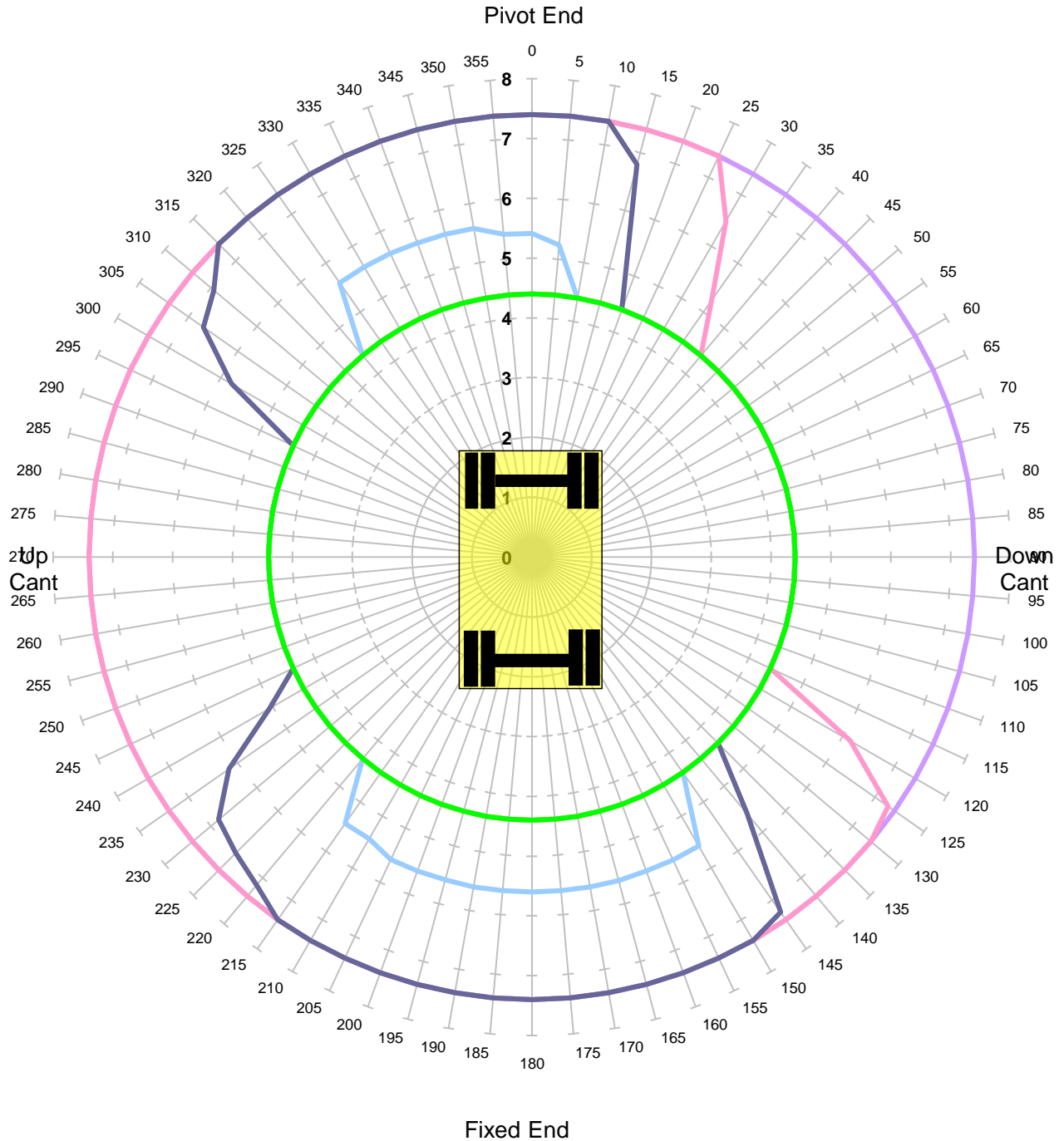

Units in Tonnes

- 1
- 2
- 3
- 4
- 5
- 6
- 7

MACHINE & MODEL:	Komatsu PW160	REFERENCE:	
SERIAL No:	H55147	DATE OF CHART:	23-Jul-2020
EQUIPMENT:	5.15m + 2.10m	SAFETY FACTOR:	90.0%
COMMENT:			



KING TRANSPORT EQUIPMENT LTD

**Max Capacity Contours of Radius(m) Plots 2.1m Dipper
Gradient 1 in -25 Height 2m Lift BP**

Locked Rail Cant -50mm

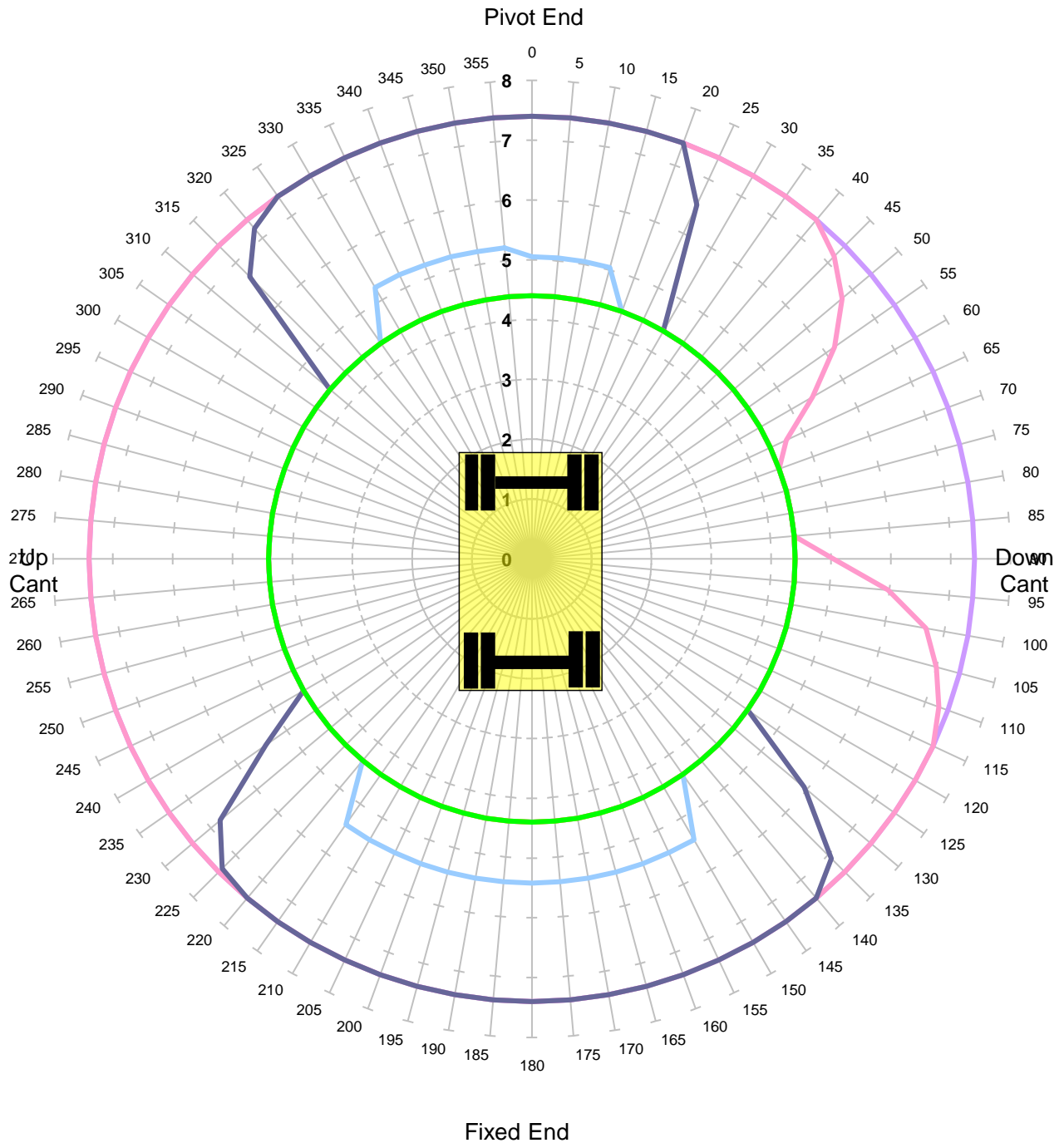

Units in Tonnes

- 1
- 2
- 3
- 4
- 5
- 6
- 7

MACHINE & MODEL:	Komatsu PW160	REFERENCE:	
SERIAL No:	H55147	DATE OF CHART:	23-Jul-2020
EQUIPMENT:	5.15m + 2.10m	SAFETY FACTOR:	90.0%
COMMENT:			



KING TRANSPORT EQUIPMENT LTD

**Max Capacity Contours of Radius(m) Plots 2.1m Dipper
Gradient 1 in -25 Height 2m Lift BP**

Locked Rail Cant 50mm

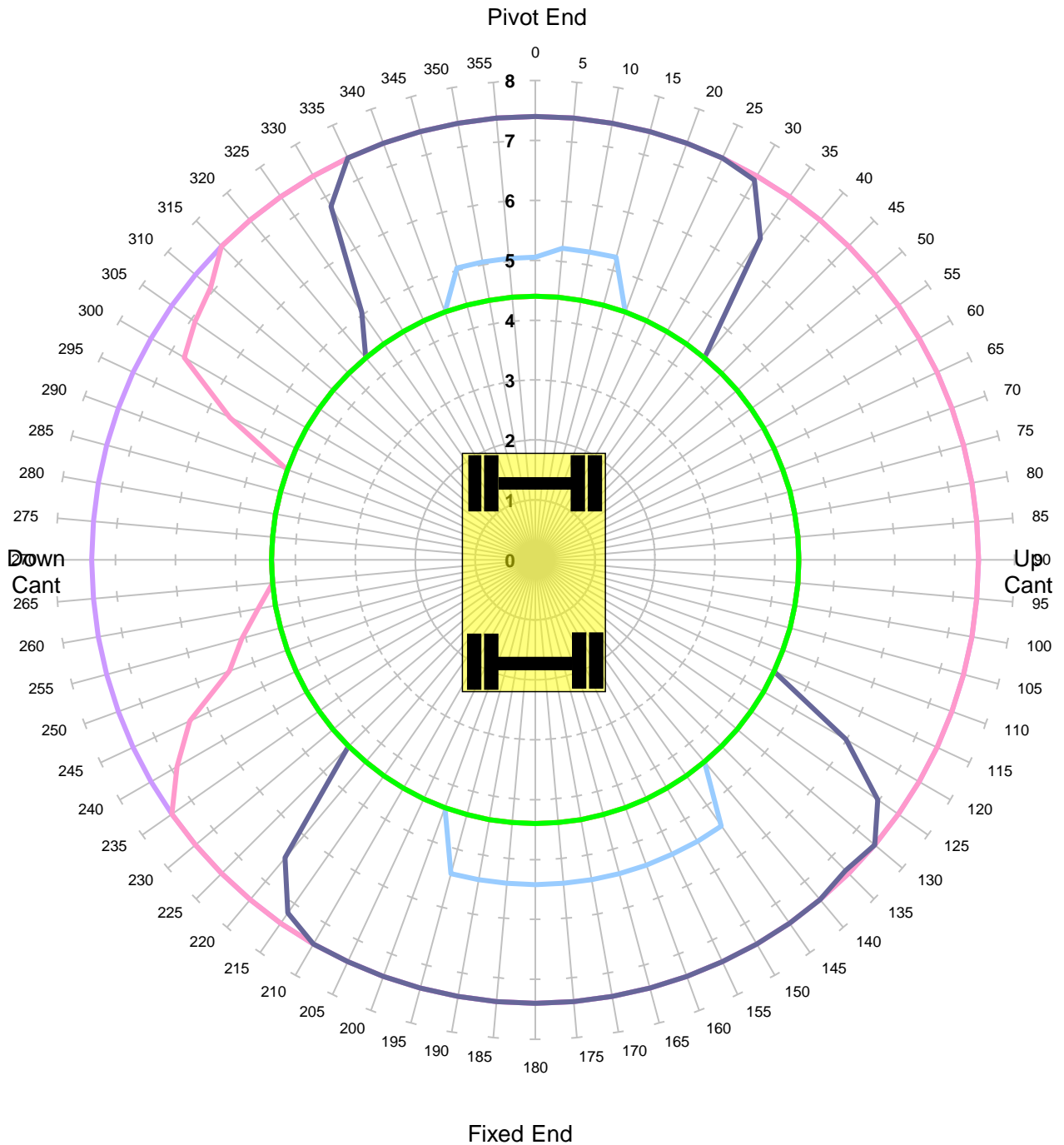

Units in Tonnes

- 1
- 2
- 3
- 4
- 5
- 6
- 7

MACHINE & MODEL:	Komatsu PW160	REFERENCE:	
SERIAL No:	H55147	DATE OF CHART:	23-Jul-2020
EQUIPMENT:	5.15m + 2.10m	SAFETY FACTOR:	90.0%
COMMENT:			



KING TRANSPORT EQUIPMENT LTD

**Max Capacity Contours of Radius(m) Plots 2.1m Dipper
Gradient 1 in -25 Height 2m Lift BP**

Locked Rail Cant 150mm

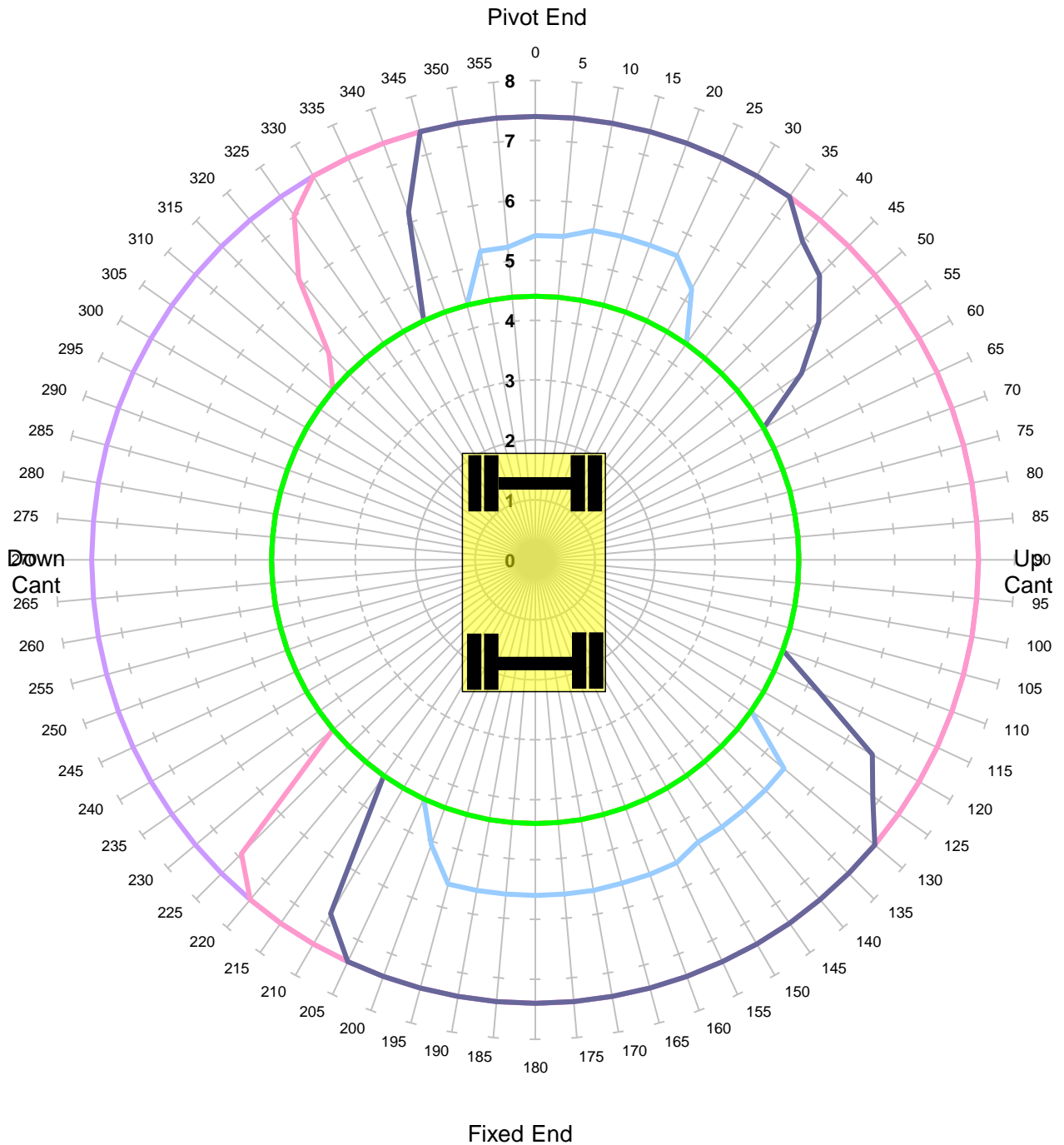

Units in Tonnes

- 1
- 2
- 3
- 4
- 5
- 6
- 7

MACHINE & MODEL:	Komatsu PW160	REFERENCE:	
SERIAL No:	H55147	DATE OF CHART:	23-Jul-2020
EQUIPMENT:	5.15m + 2.10m	SAFETY FACTOR:	90.0%
COMMENT:			



KING TRANSPORT EQUIPMENT LTD

**Max Capacity Contours of Radius(m) Plots 2.1m Dipper
Level Ground Height 2m Lift BP**

Unlocked Road

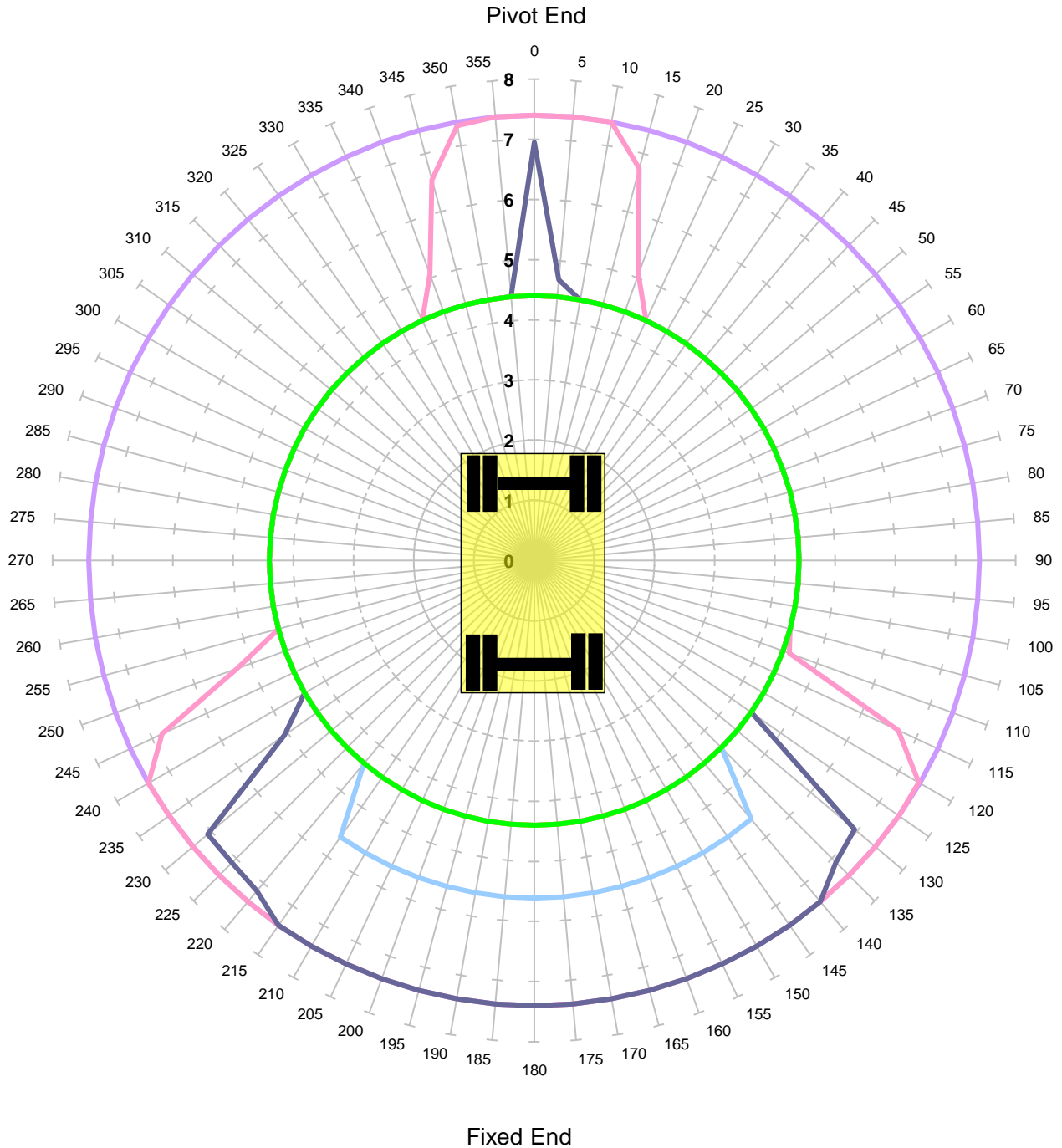

Units in Tonnes

- 1
- 2
- 3
- 4
- 5
- 6
- 7

MACHINE & MODEL:	Komatsu PW160	REFERENCE:	
SERIAL No:	H55147	DATE OF CHART:	23-Jul-2020
EQUIPMENT:	5.15m + 2.10m	SAFETY FACTOR:	71.0%
COMMENT:			



KING TRANSPORT EQUIPMENT LTD

Max Capacity Contours of Radius(m) Plots 2.1m Dipper
Level Ground Height 2m Lift BP

Locked Road

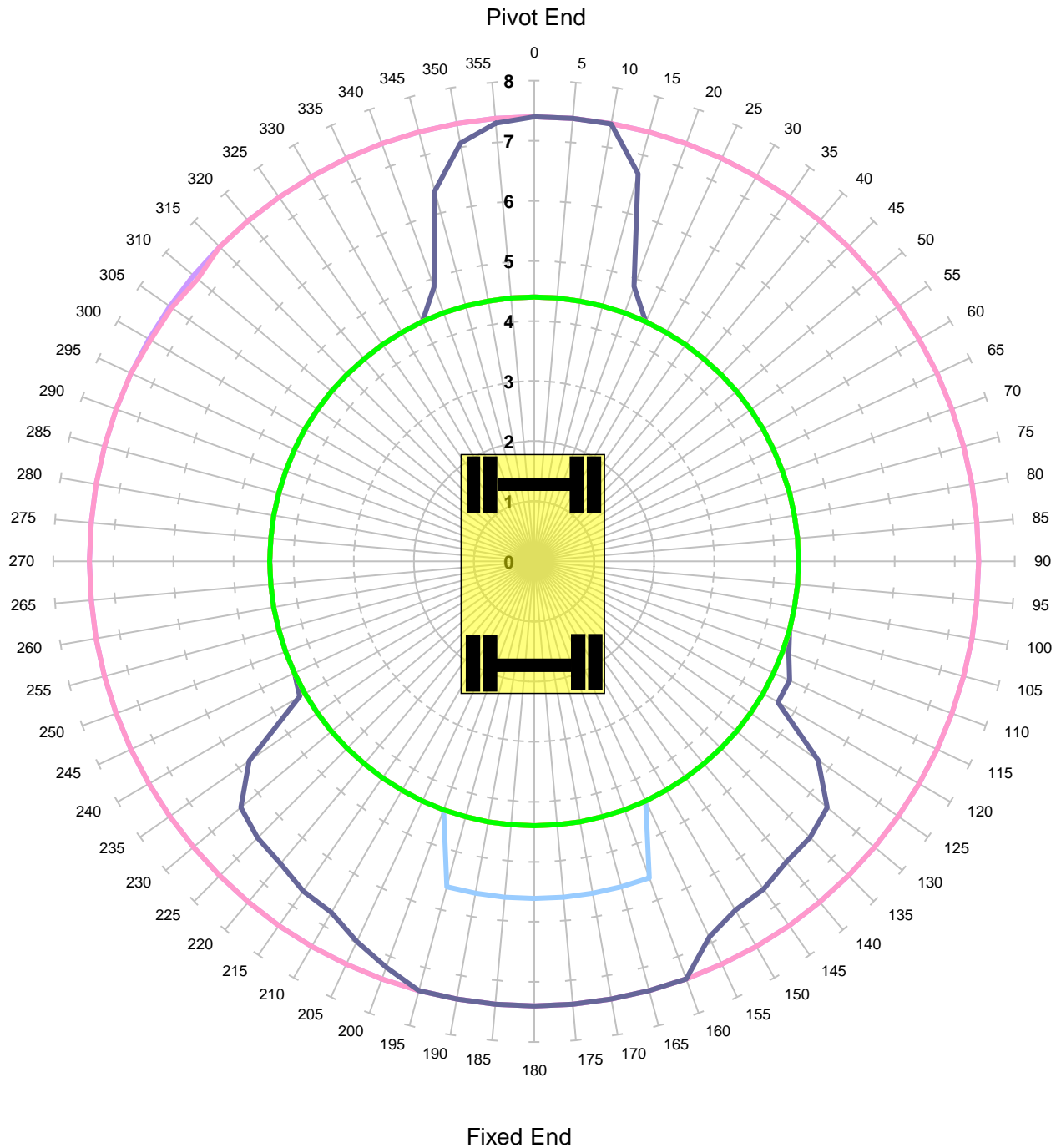

Units in Tonnes

- 1
- 2
- 3
- 4
- 5
- 6
- 7

MACHINE & MODEL:	Komatsu PW160	REFERENCE:	
SERIAL No:	H55147	DATE OF CHART:	23-Jul-2020
EQUIPMENT:	5.15m + 2.10m	SAFETY FACTOR:	71.0%
COMMENT:			



KING TRANSPORT EQUIPMENT LTD

**Max Capacity Contours of Radius(m) Plots 2.1m Dipper
Gradient 1 in -25 Height 2m Lift BP**

Unlocked Rail Cant -150mm - Tandem Lift

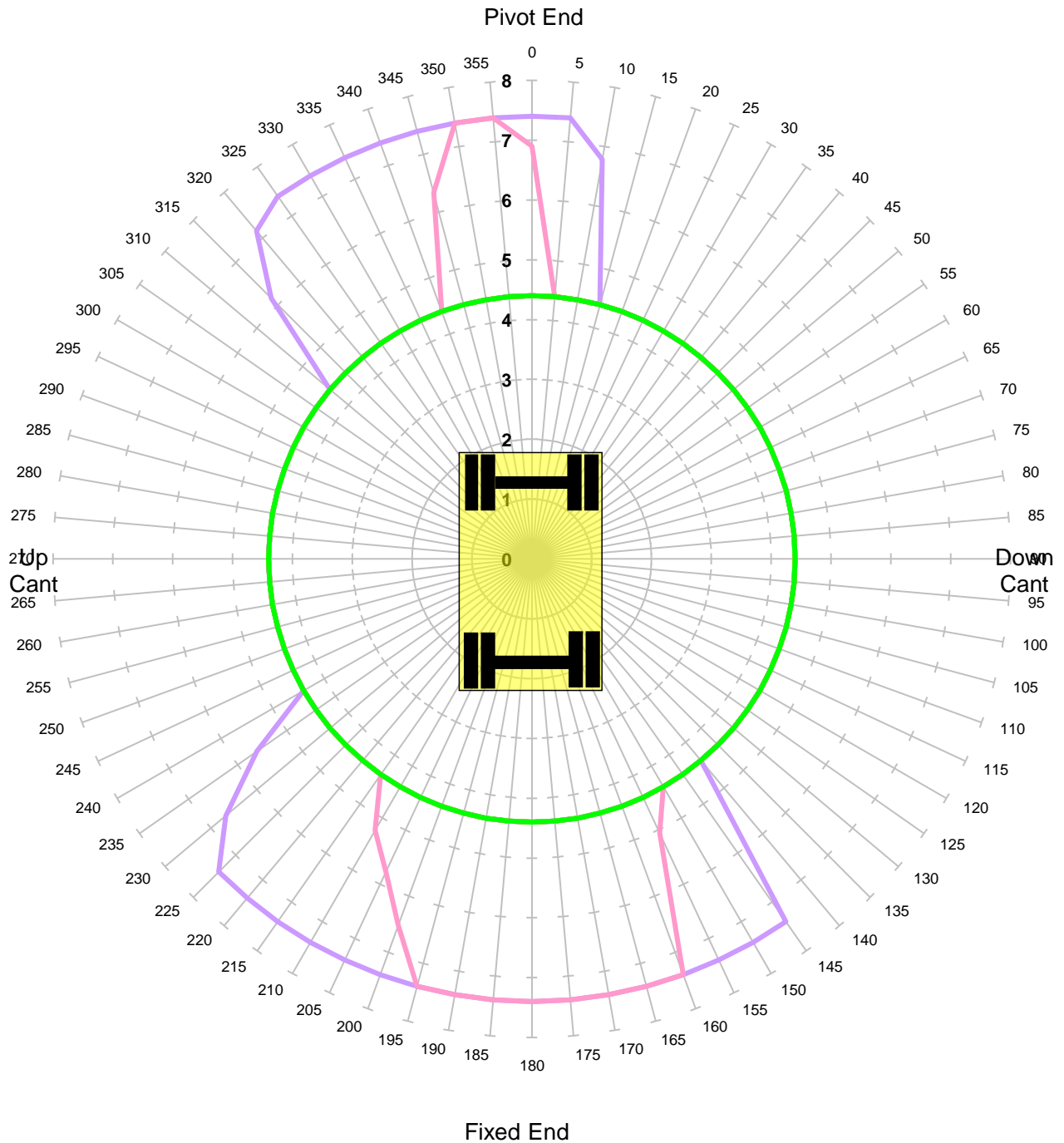

Units in Tonnes

- 1
- 2
- 3
- 4
- 5
- 6
- 7

MACHINE & MODEL:	Komatsu PW160	REFERENCE:	
SERIAL No:	H55147	DATE OF CHART:	23-Jul-2020
EQUIPMENT:	5.15m + 2.10m	SAFETY FACTOR:	44.0%
COMMENT:			



KING TRANSPORT EQUIPMENT LTD

**Max Capacity Contours of Radius(m) Plots 2.1m Dipper
Gradient 1 in -25 Height 2m Lift BP**

Unlocked Rail Cant -50mm - Tandem Lift

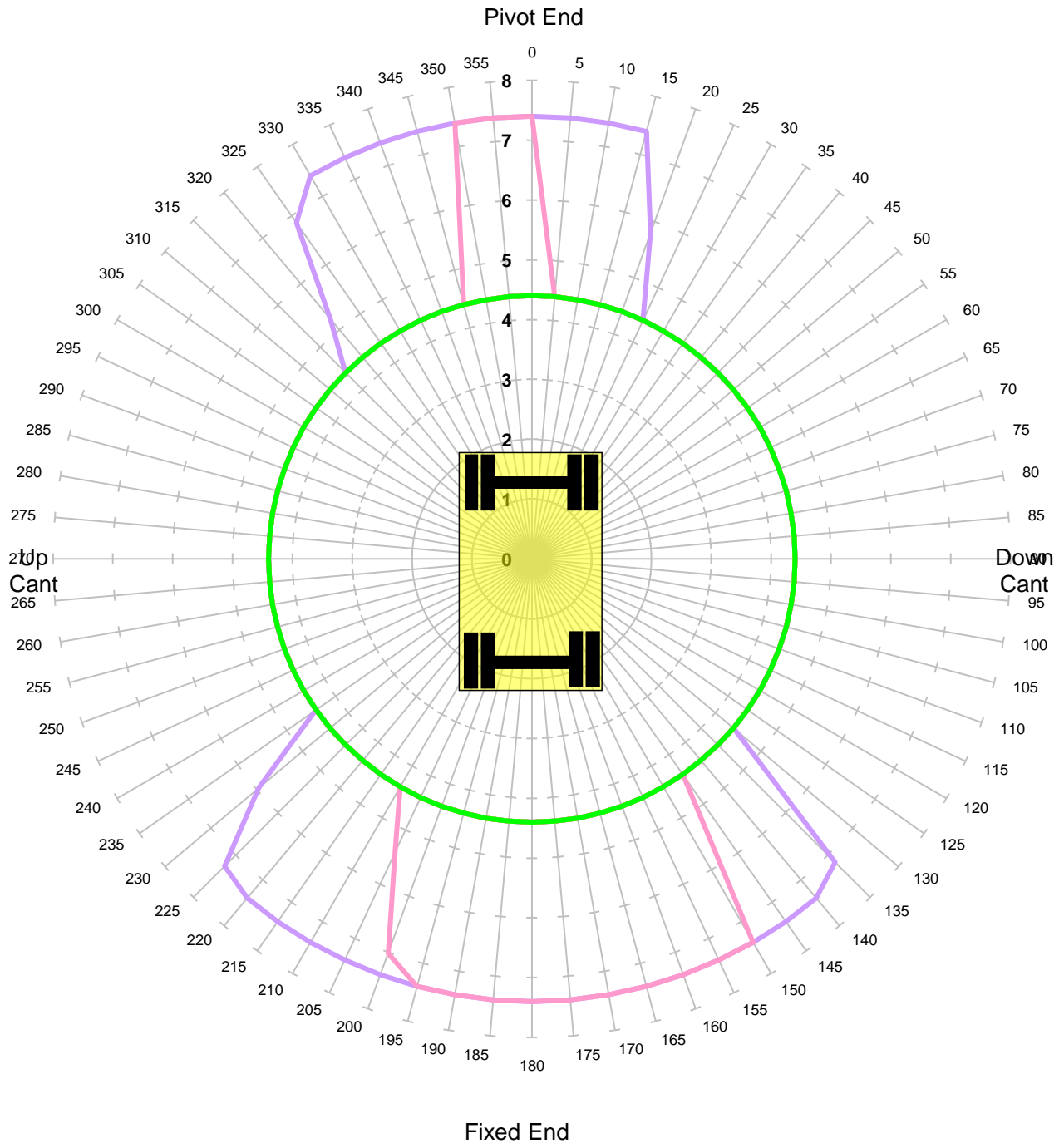

Units in Tonnes

- 1
- 2
- 3
- 4
- 5
- 6
- 7

MACHINE & MODEL:	Komatsu PW160	REFERENCE:	
SERIAL No:	H55147	DATE OF CHART:	23-Jul-2020
EQUIPMENT:	5.15m + 2.10m	SAFETY FACTOR:	44.0%
COMMENT:			



KING TRANSPORT EQUIPMENT LTD

**Max Capacity Contours of Radius(m) Plots 2.1m Dipper
Gradient 1 in -25 Height 2m Lift BP**

Unlocked Rail Cant 50mm - Tandem Lift

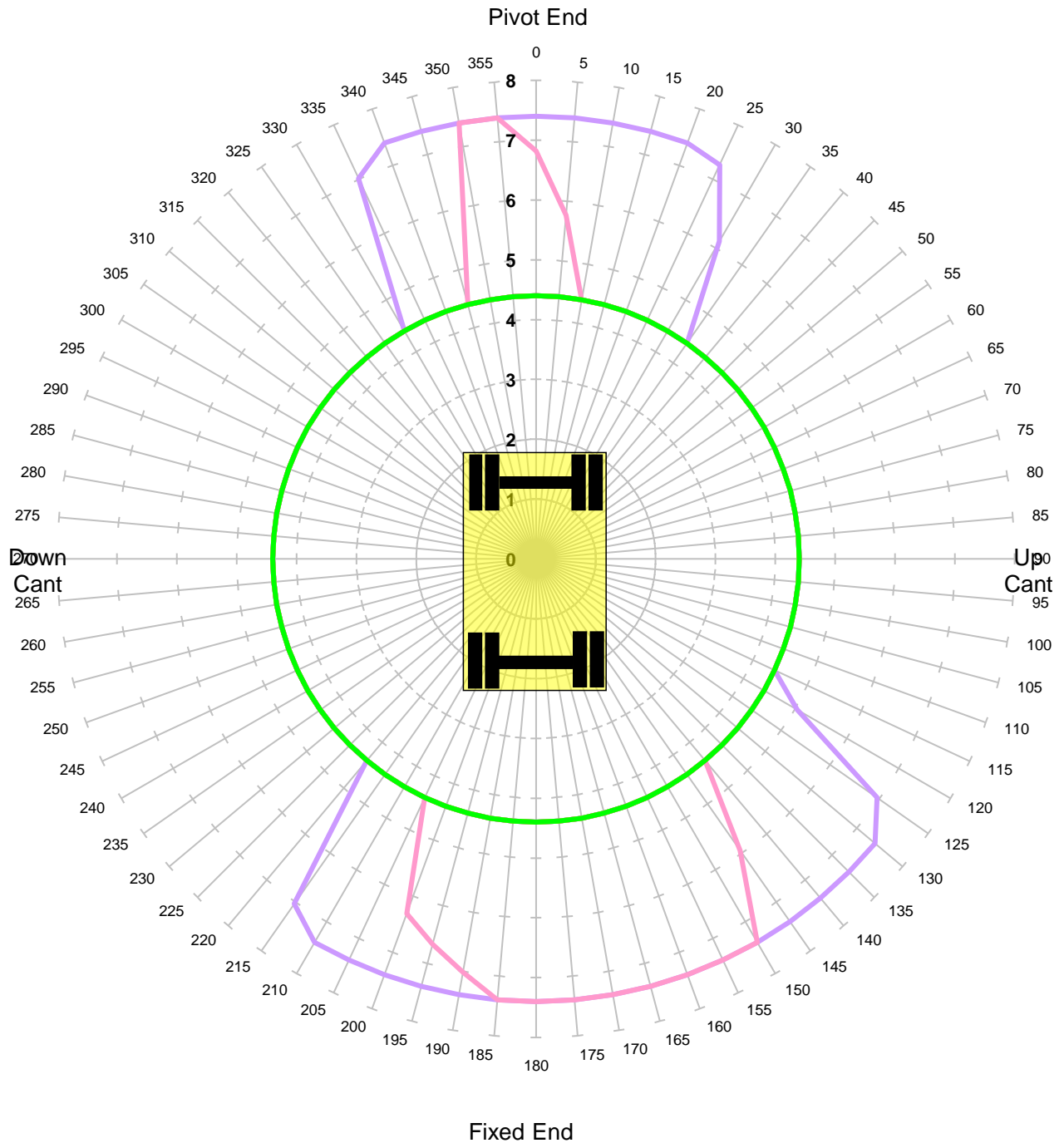

Units in Tonnes

- 1
- 2
- 3
- 4
- 5
- 6
- 7

MACHINE & MODEL:	Komatsu PW160	REFERENCE:	
SERIAL No:	H55147	DATE OF CHART:	23-Jul-2020
EQUIPMENT:	5.15m + 2.10m	SAFETY FACTOR:	44.0%
COMMENT:			



KING TRANSPORT EQUIPMENT LTD

**Max Capacity Contours of Radius(m) Plots 2.1m Dipper
Gradient 1 in -25 Height 2m Lift BP**

Unlocked Rail Cant 150mm - Tandem Lift

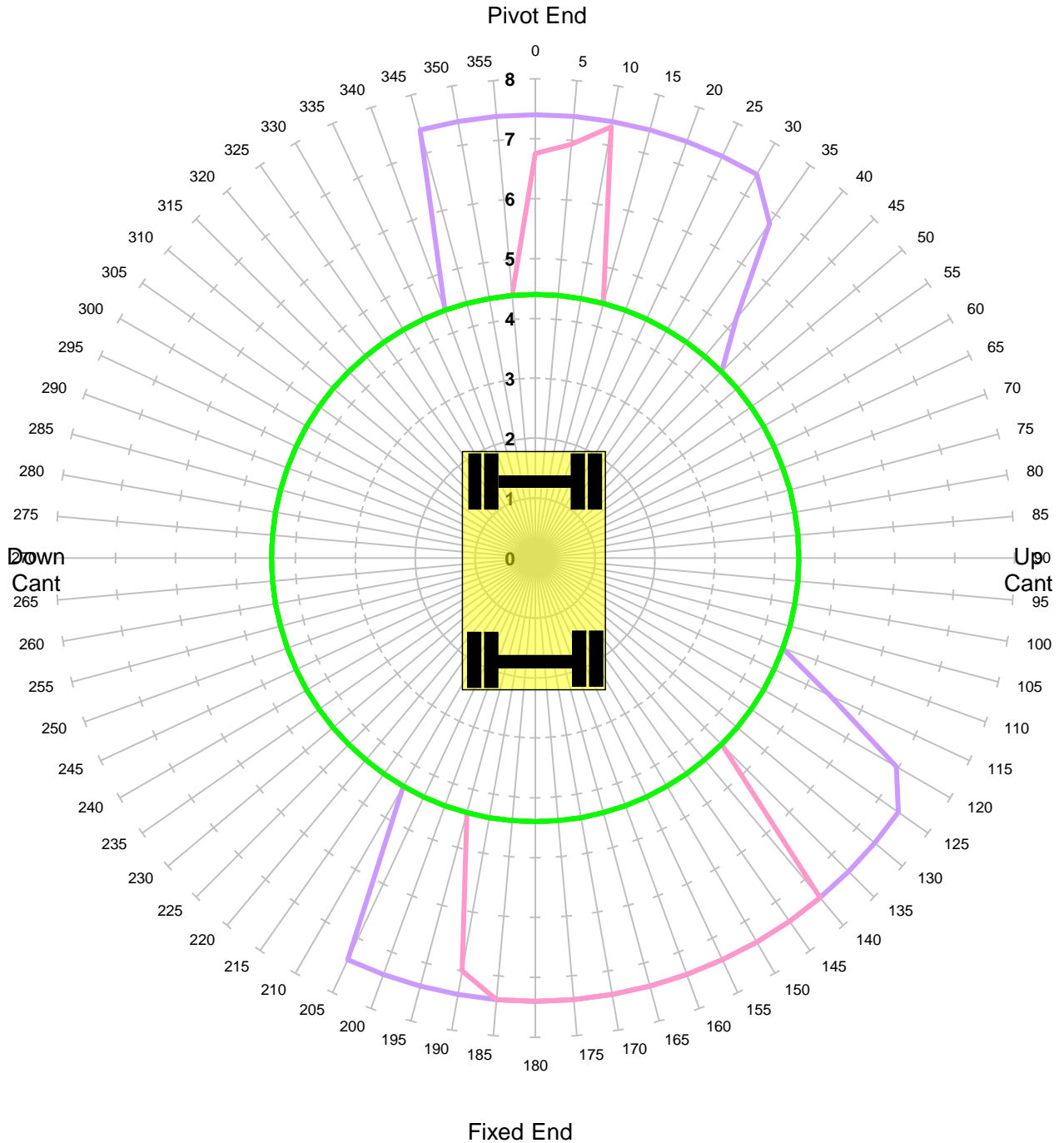

Units in Tonnes

- 1
- 2
- 3
- 4
- 5
- 6
- 7

MACHINE & MODEL: SERIAL No: EQUIPMENT: COMMENT:	Komatsu PW160 H55147 5.15m + 2.10m	REFERENCE: DATE OF CHART: SAFETY FACTOR:	23-Jul-2020 44.0%



KING TRANSPORT EQUIPMENT LTD

**Max Capacity Contours of Radius(m) Plots 2.1m Dipper
Gradient 1 in -25 Height 2m Lift BP**

Locked Rail Cant -150mm - Tandem Lift

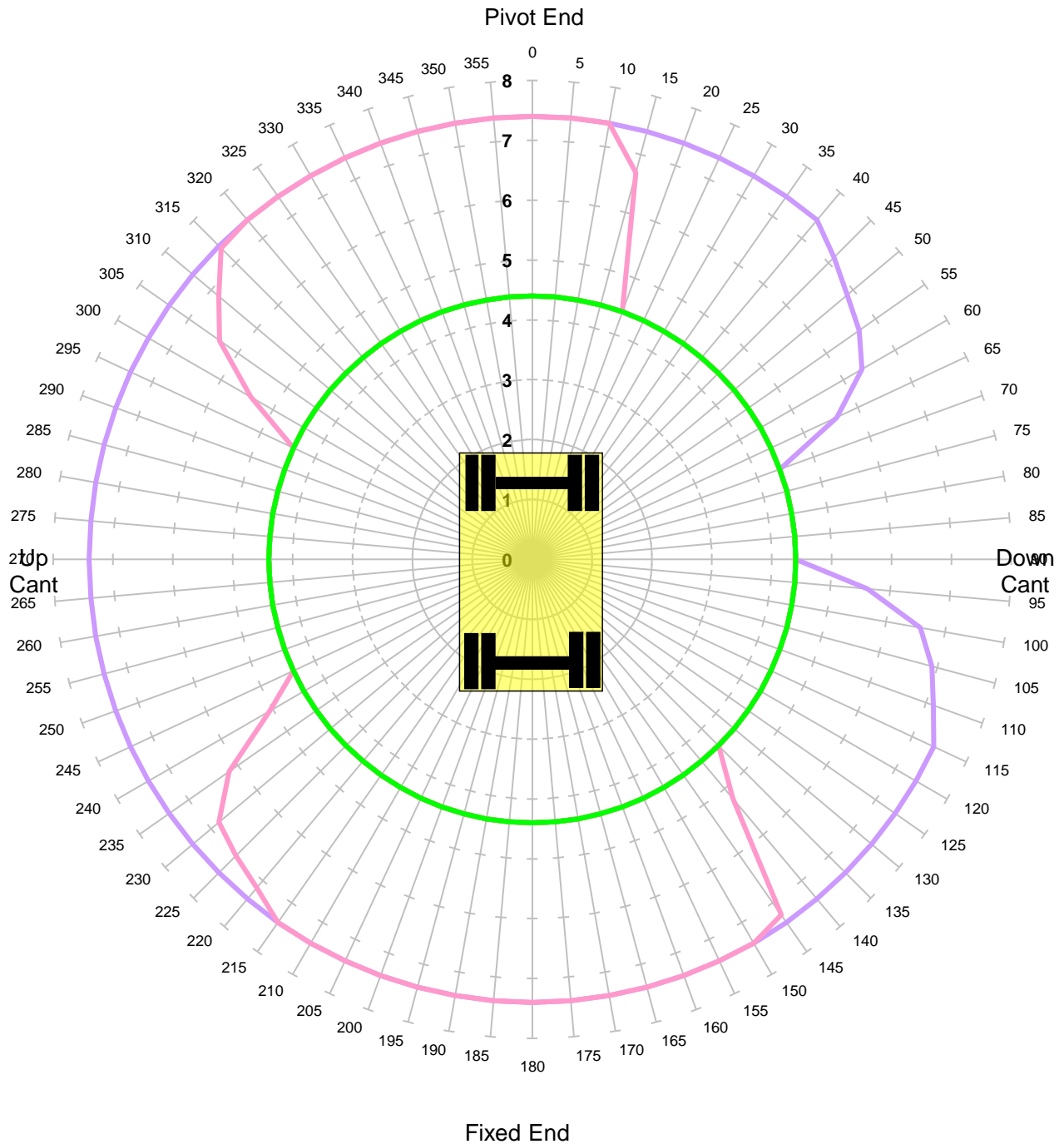

Units in Tonnes

- 1
- 2
- 3
- 4
- 5
- 6
- 7

MACHINE & MODEL:	Komatsu PW160	REFERENCE:	
SERIAL No:	H55147	DATE OF CHART:	23-Jul-2020
EQUIPMENT:	5.15m + 2.10m	SAFETY FACTOR:	59.0%
COMMENT:			



KING TRANSPORT EQUIPMENT LTD

**Max Capacity Contours of Radius(m) Plots 2.1m Dipper
Gradient 1 in -25 Height 2m Lift BP**

Locked Rail Cant -50mm - Tandem Lift

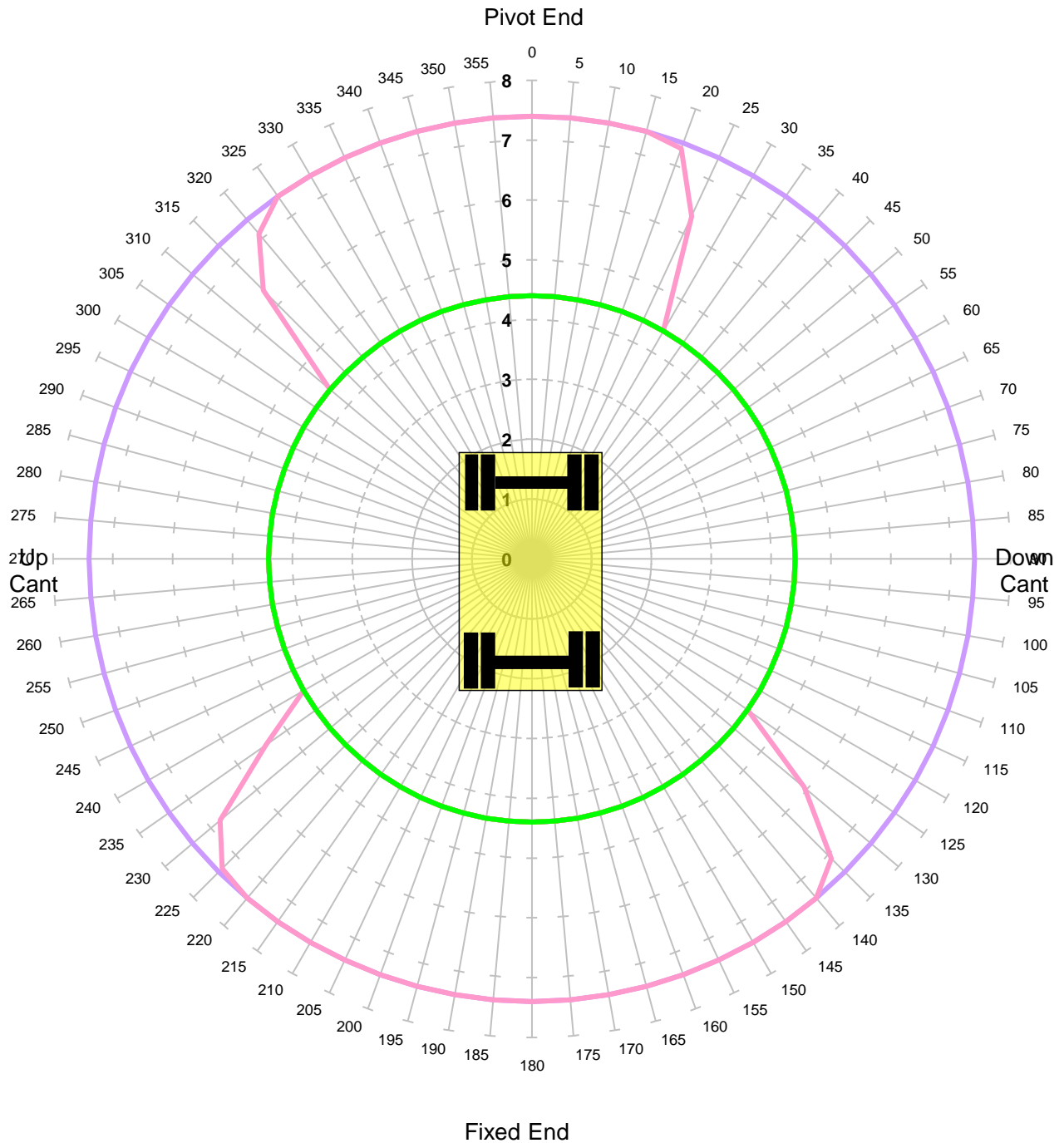

Units in Tonnes

- 1
- 2
- 3
- 4
- 5
- 6
- 7

MACHINE & MODEL:	Komatsu PW160	REFERENCE:	
SERIAL No:	H55147	DATE OF CHART:	23-Jul-2020
EQUIPMENT:	5.15m + 2.10m	SAFETY FACTOR:	59.0%
COMMENT:			



KING TRANSPORT EQUIPMENT LTD

**Max Capacity Contours of Radius(m) Plots 2.1m Dipper
Gradient 1 in -25 Height 2m Lift BP**

Locked Rail Cant 50mm - Tandem Lift

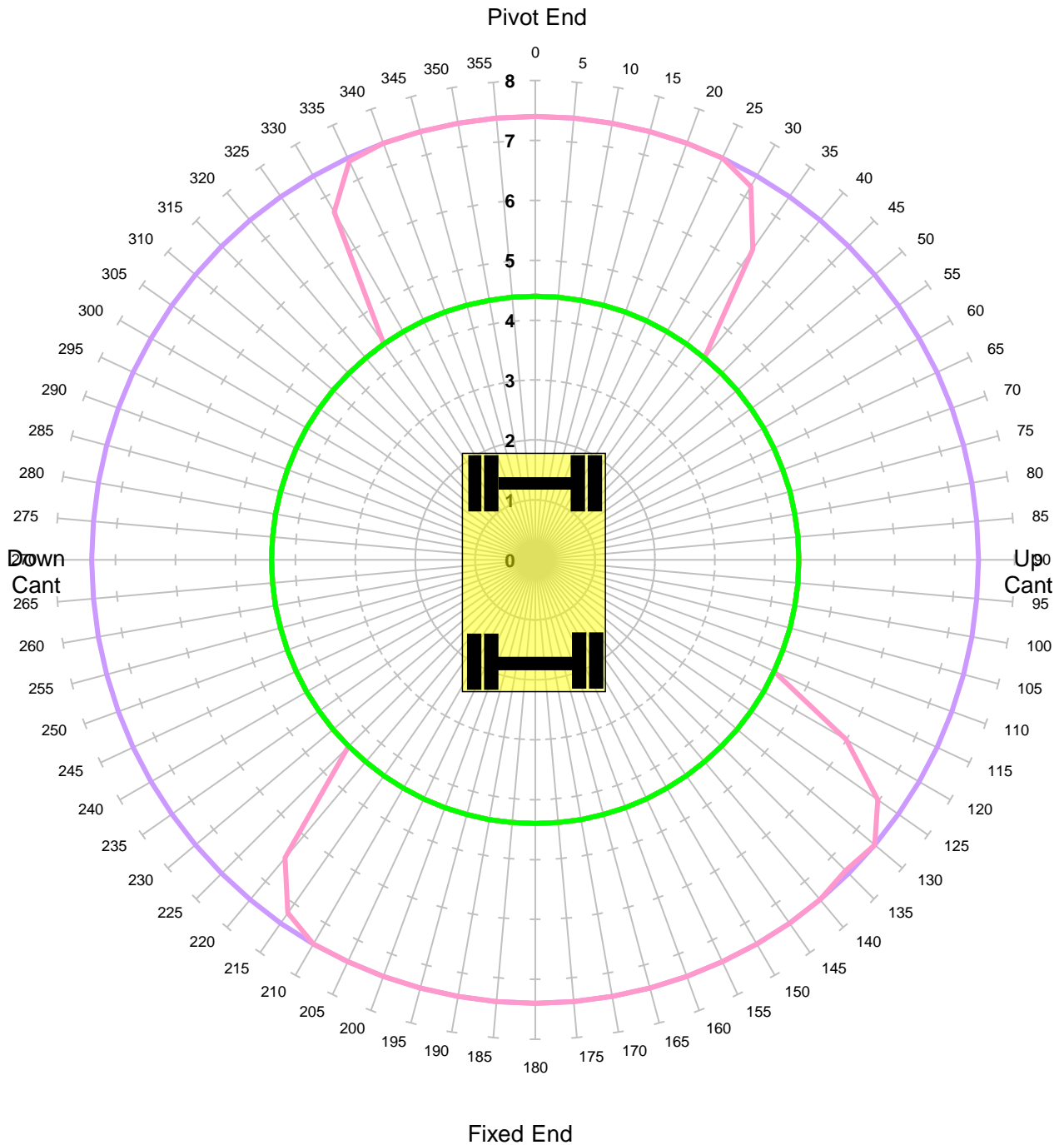

Units in Tonnes

- 1
- 2
- 3
- 4
- 5
- 6
- 7

MACHINE & MODEL:	Komatsu PW160	REFERENCE:	
SERIAL No:	H55147	DATE OF CHART:	23-Jul-2020
EQUIPMENT:	5.15m + 2.10m	SAFETY FACTOR:	59.0%
COMMENT:			



KING TRANSPORT EQUIPMENT LTD

**Max Capacity Contours of Radius(m) Plots 2.1m Dipper
Gradient 1 in -25 Height 2m Lift BP**

Locked Rail Cant 150mm - Tandem Lift

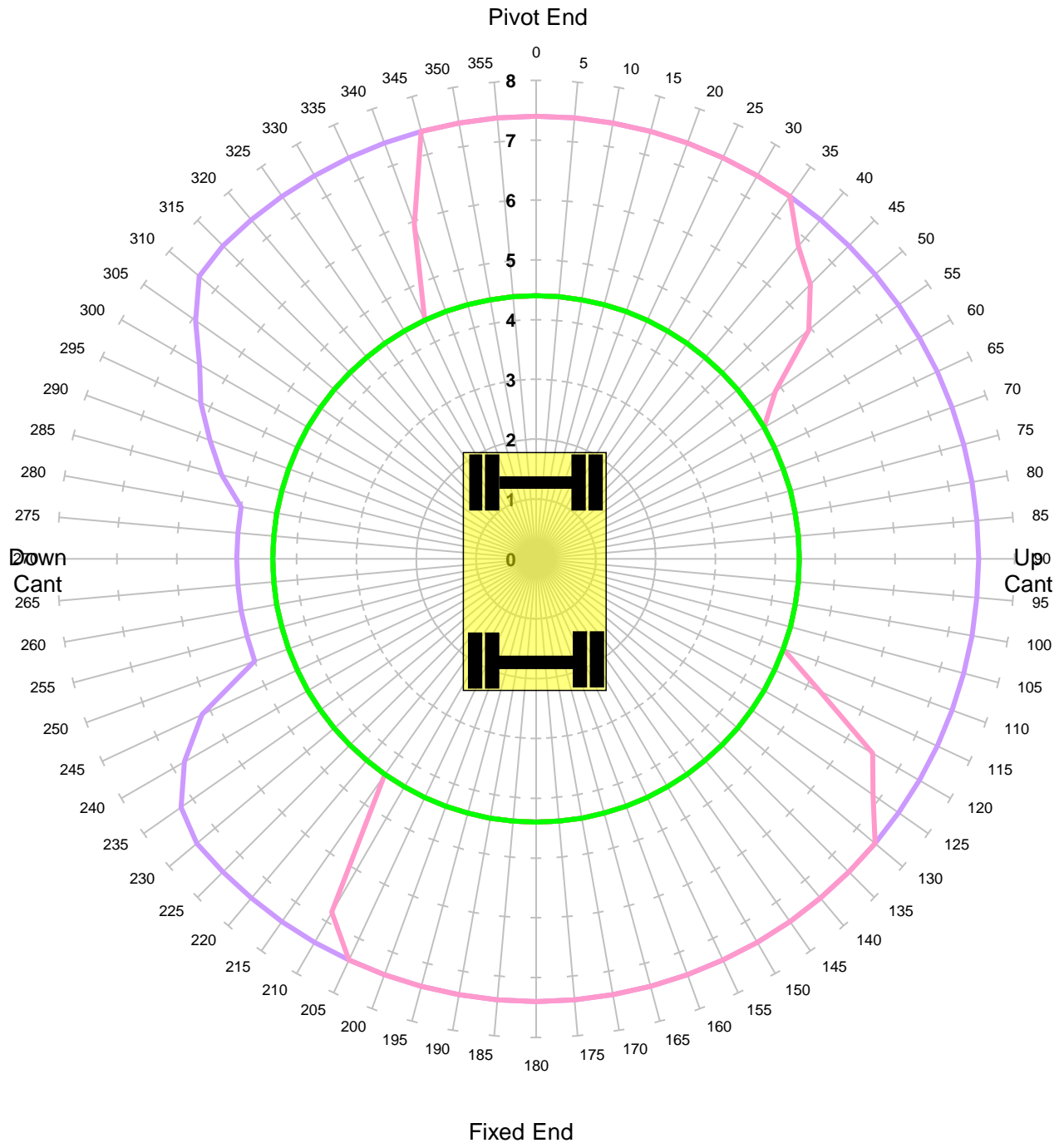

Units in Tonnes

- 1
- 2
- 3
- 4
- 5
- 6
- 7

MACHINE & MODEL: SERIAL No: EQUIPMENT: COMMENT:	Komatsu PW160 H55147 5.15m + 2.10m	REFERENCE: DATE OF CHART: SAFETY FACTOR:	23-Jul-2020 59.0%



KING TRANSPORT EQUIPMENT LTD

**Max Capacity Contours of Radius(m) Plots 2.1m Dipper
Level Ground Height 2m Lift BP**

Unlocked Road - Tandem Lift

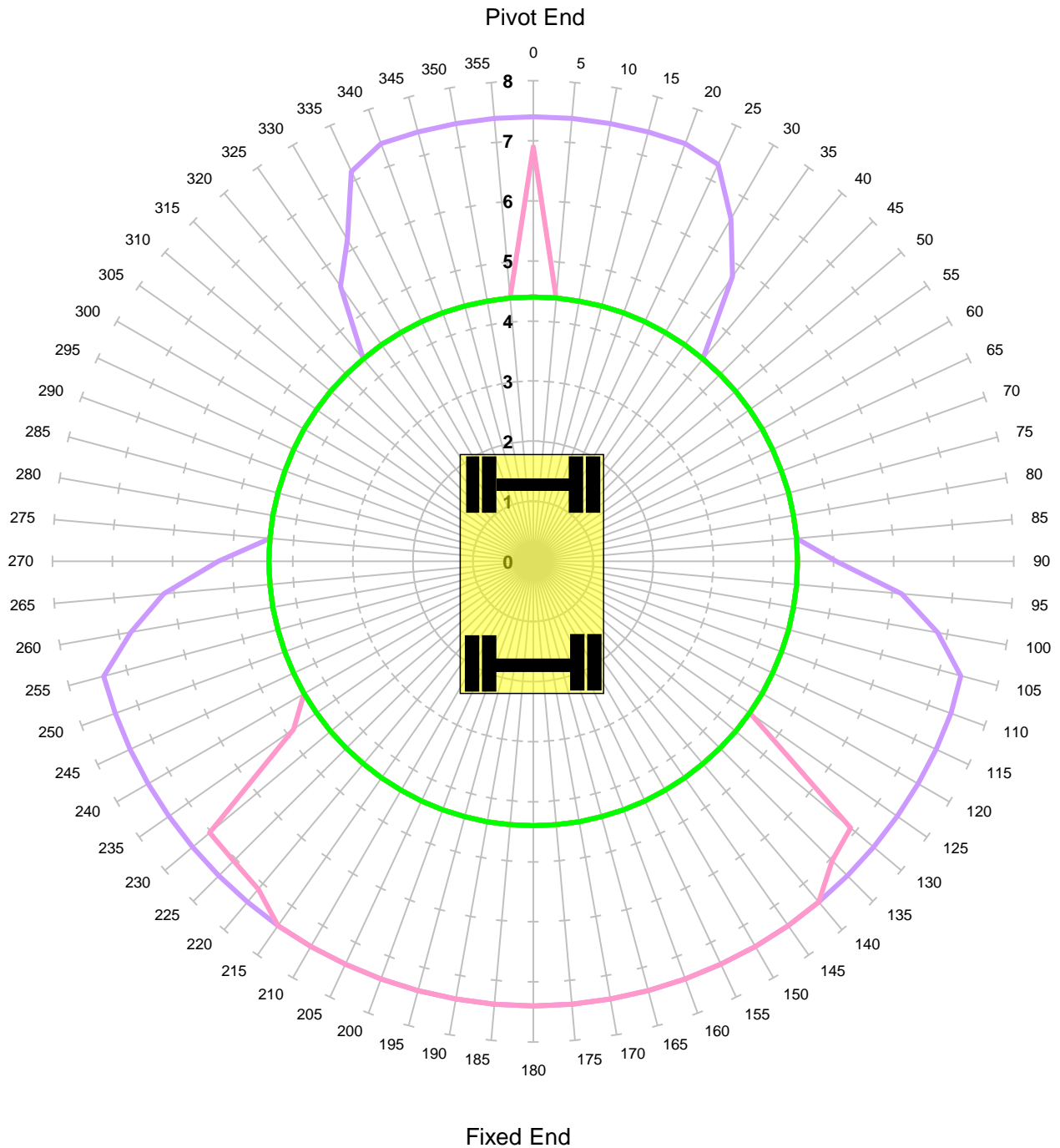

Units in Tonnes

— 1 — 2 — 3 — 4 — 5 — 6 — 7

MACHINE & MODEL:	Komatsu PW160	REFERENCE:	
SERIAL No:	H55147	DATE OF CHART:	23-Jul-2020
EQUIPMENT:	5.15m + 2.10m	SAFETY FACTOR:	47.0%
COMMENT:			



KING TRANSPORT EQUIPMENT LTD

**Max Capacity Contours of Radius(m) Plots 2.1m Dipper
Level Ground Height 2m Lift BP**

Locked Road - Tandem Lift

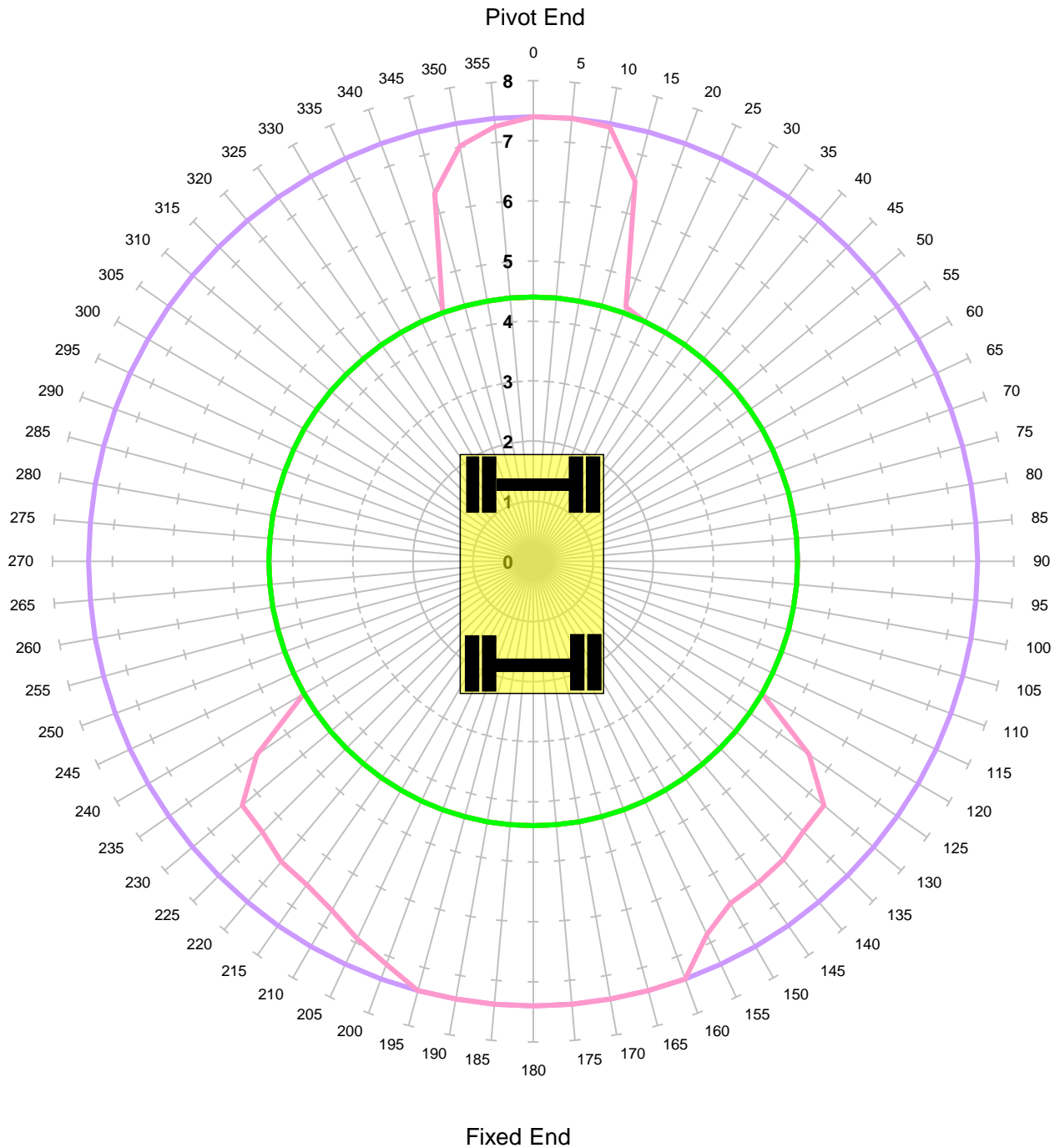

Units in Tonnes

— 1 — 2 — 3 — 4 — 5 — 6 — 7

MACHINE & MODEL:	Komatsu PW160	REFERENCE:	
SERIAL No:	H55147	DATE OF CHART:	23-Jul-2020
EQUIPMENT:	5.15m + 2.10m	SAFETY FACTOR:	47.0%
COMMENT:			



KING TRANSPORT EQUIPMENT LTD

**Max Capacity Contours of Radius(m) Plots 2.1m Dipper
Gradient 1 in -25 Height 2m Lift QH**

Unlocked Rail Cant -150mm

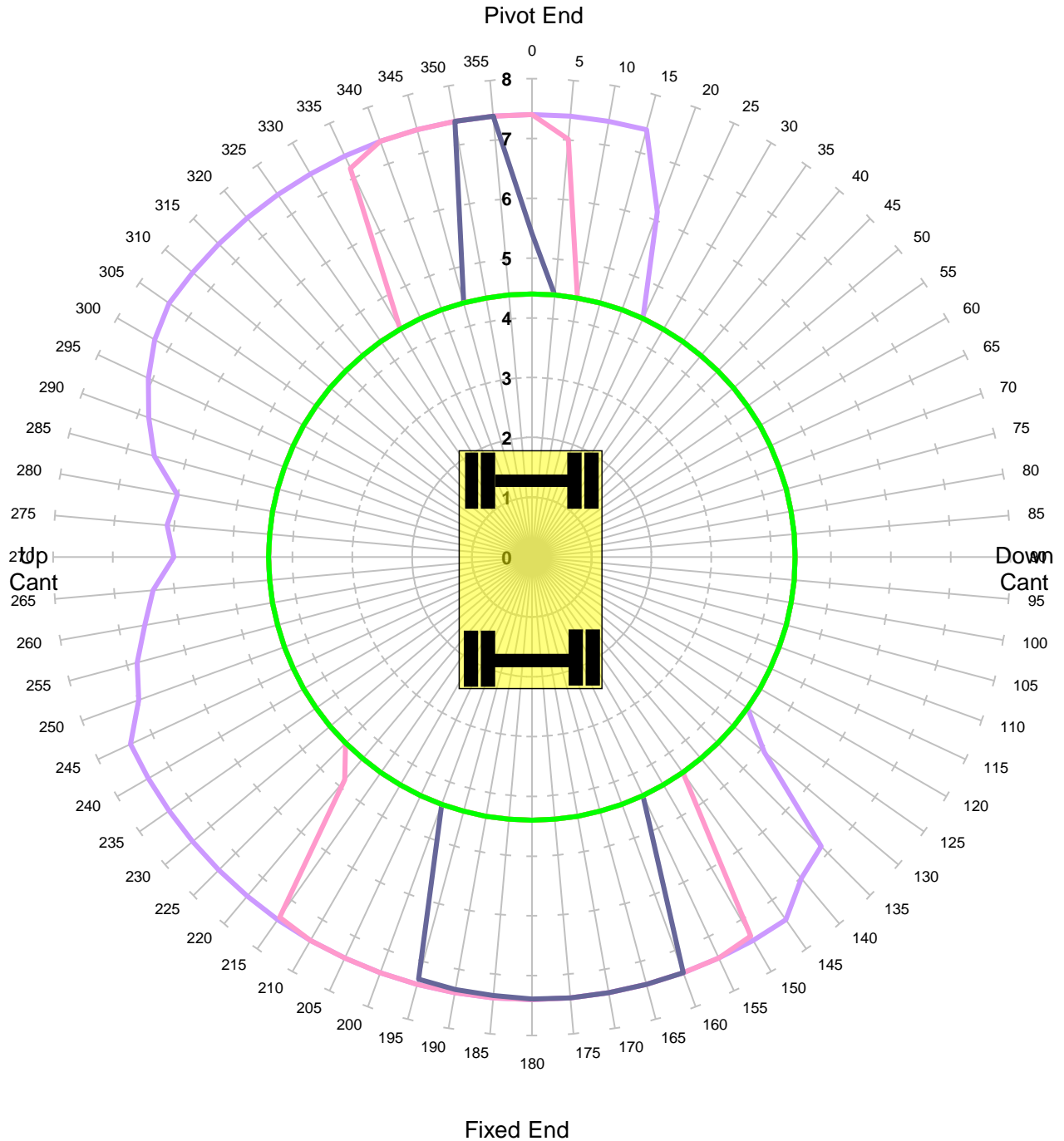

Units in Tonnes

- 1
- 2
- 3
- 4
- 5
- 6
- 7

MACHINE & MODEL:	Komatsu PW160	REFERENCE:	
SERIAL No:	H55147	DATE OF CHART:	23-Jul-2020
EQUIPMENT:	5.15m + 2.10m	SAFETY FACTOR:	67.0%
COMMENT:			



KING TRANSPORT EQUIPMENT LTD

**Max Capacity Contours of Radius(m) Plots 2.1m Dipper
Gradient 1 in -25 Height 2m Lift QH**

Unlocked Rail Cant -50mm

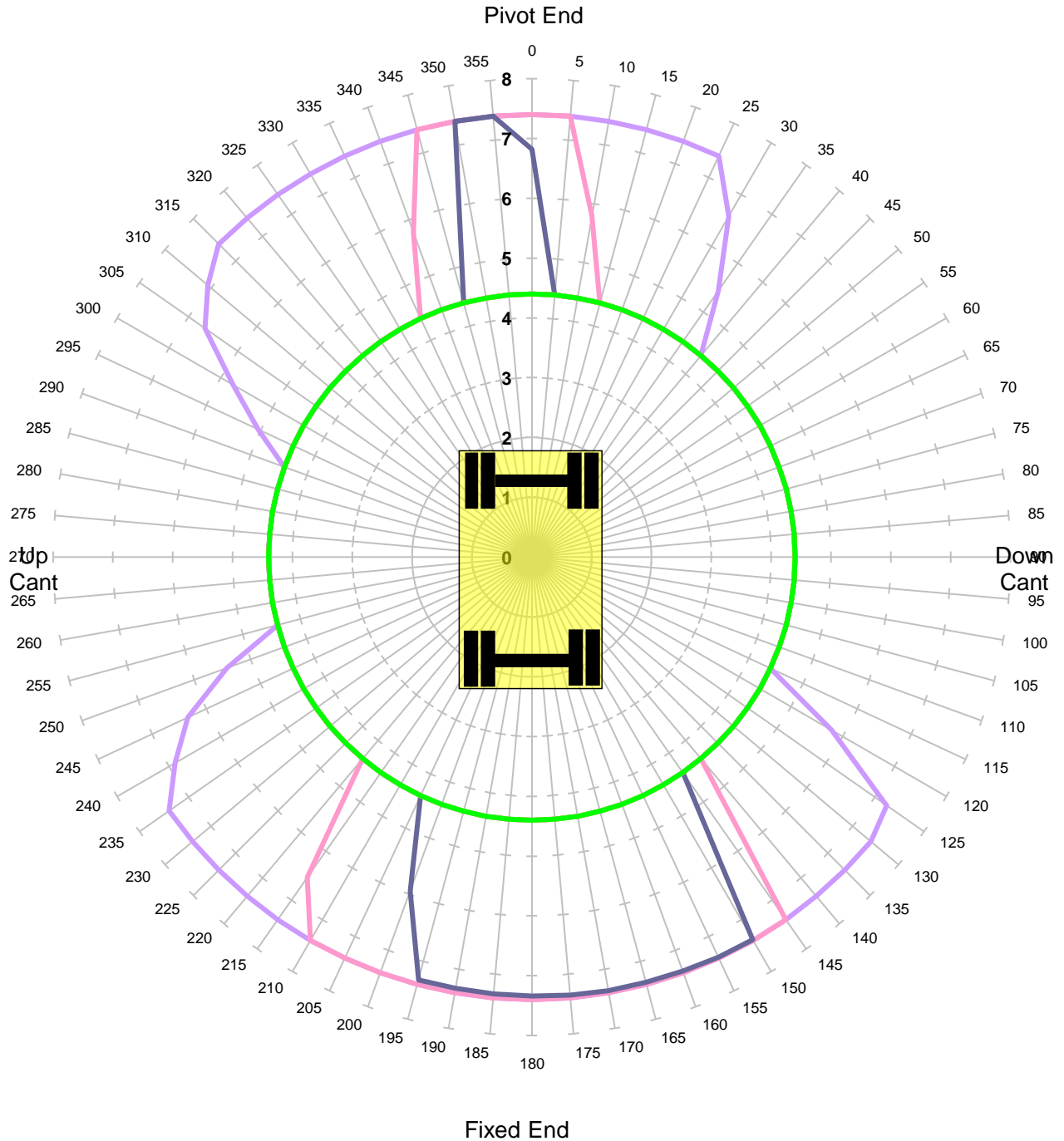

Units in Tonnes

- 1
- 2
- 3
- 4
- 5
- 6
- 7

MACHINE & MODEL:	Komatsu PW160	REFERENCE:	
SERIAL No:	H55147	DATE OF CHART:	23-Jul-2020
EQUIPMENT:	5.15m + 2.10m	SAFETY FACTOR:	67.0%
COMMENT:			



KING TRANSPORT EQUIPMENT LTD

**Max Capacity Contours of Radius(m) Plots 2.1m Dipper
Gradient 1 in -25 Height 2m Lift QH**

Unlocked Rail Cant 50mm

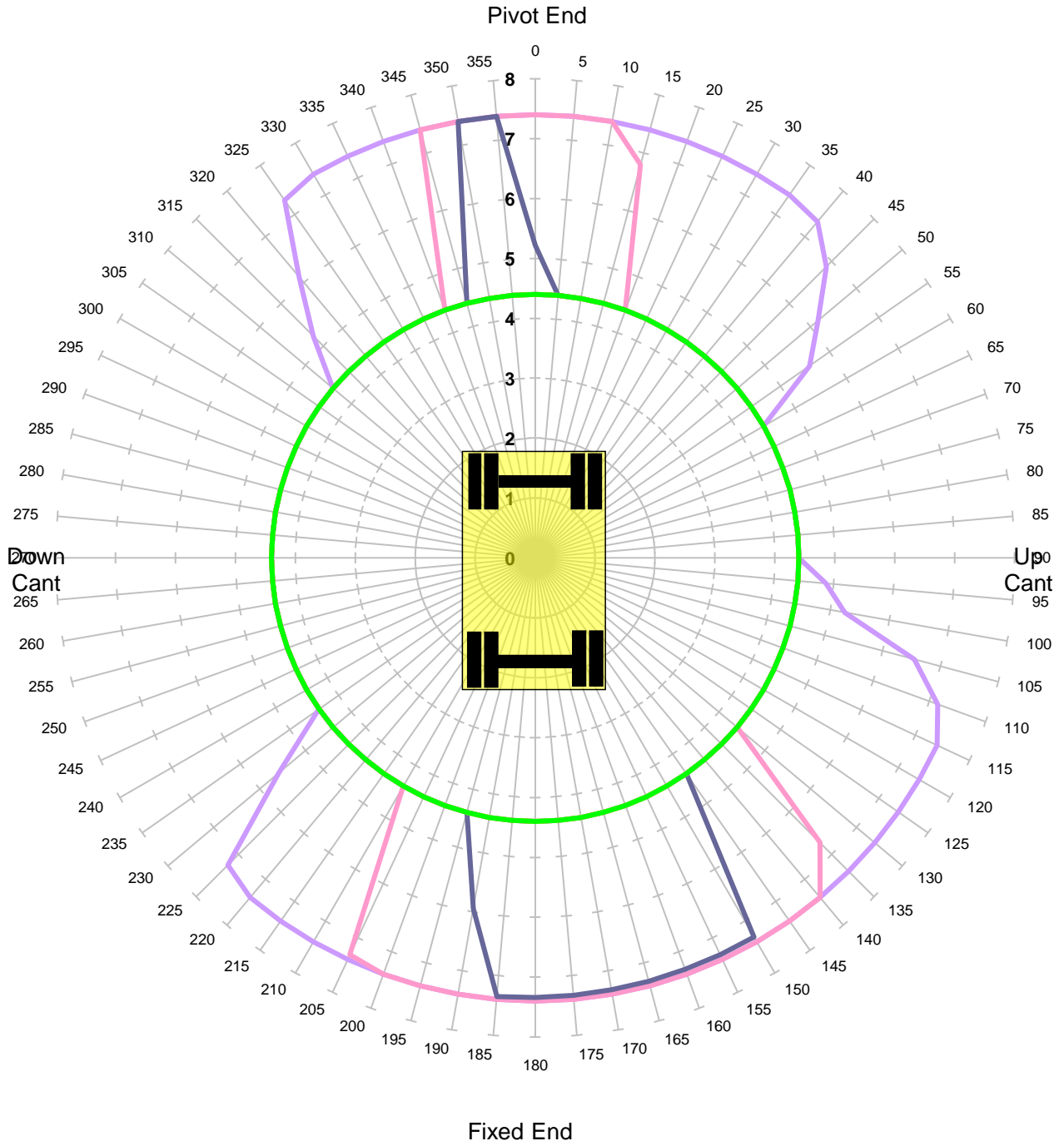

Units in Tonnes

- 1
- 2
- 3
- 4
- 5
- 6
- 7

MACHINE & MODEL:	Komatsu PW160	REFERENCE:	
SERIAL No:	H55147	DATE OF CHART:	23-Jul-2020
EQUIPMENT:	5.15m + 2.10m	SAFETY FACTOR:	67.0%
COMMENT:			



KING TRANSPORT EQUIPMENT LTD

**Max Capacity Contours of Radius(m) Plots 2.1m Dipper
Gradient 1 in -25 Height 2m Lift QH**

Unlocked Rail Cant 150mm

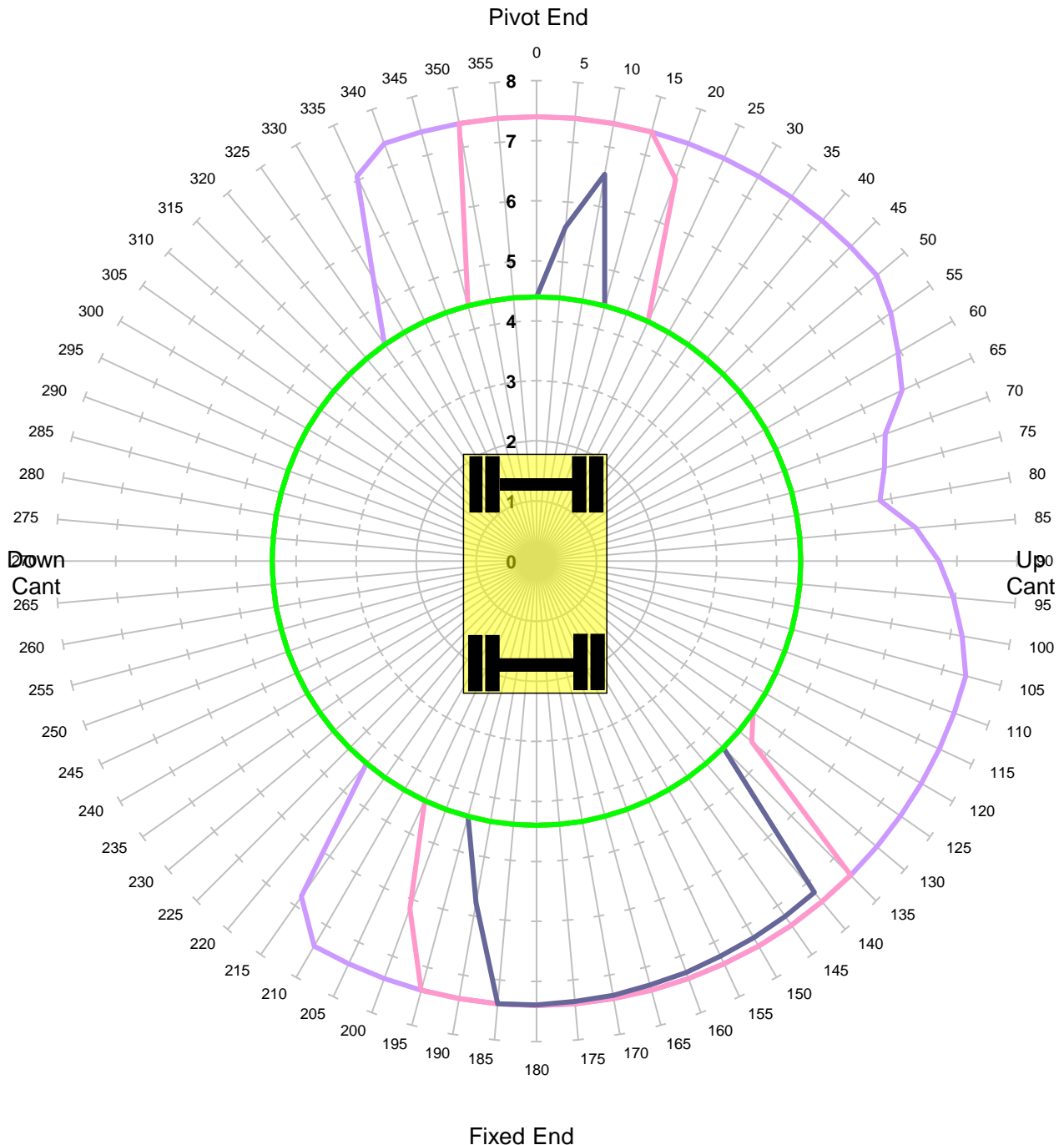

Units in Tonnes

- 1
- 2
- 3
- 4
- 5
- 6
- 7

MACHINE & MODEL:	Komatsu PW160	REFERENCE:	
SERIAL No:	H55147	DATE OF CHART:	23-Jul-2020
EQUIPMENT:	5.15m + 2.10m	SAFETY FACTOR:	67.0%
COMMENT:			



KING TRANSPORT EQUIPMENT LTD

**Max Capacity Contours of Radius(m) Plots 2.1m Dipper
Gradient 1 in -25 Height 2m Lift QH**

Locked Rail Cant -150mm

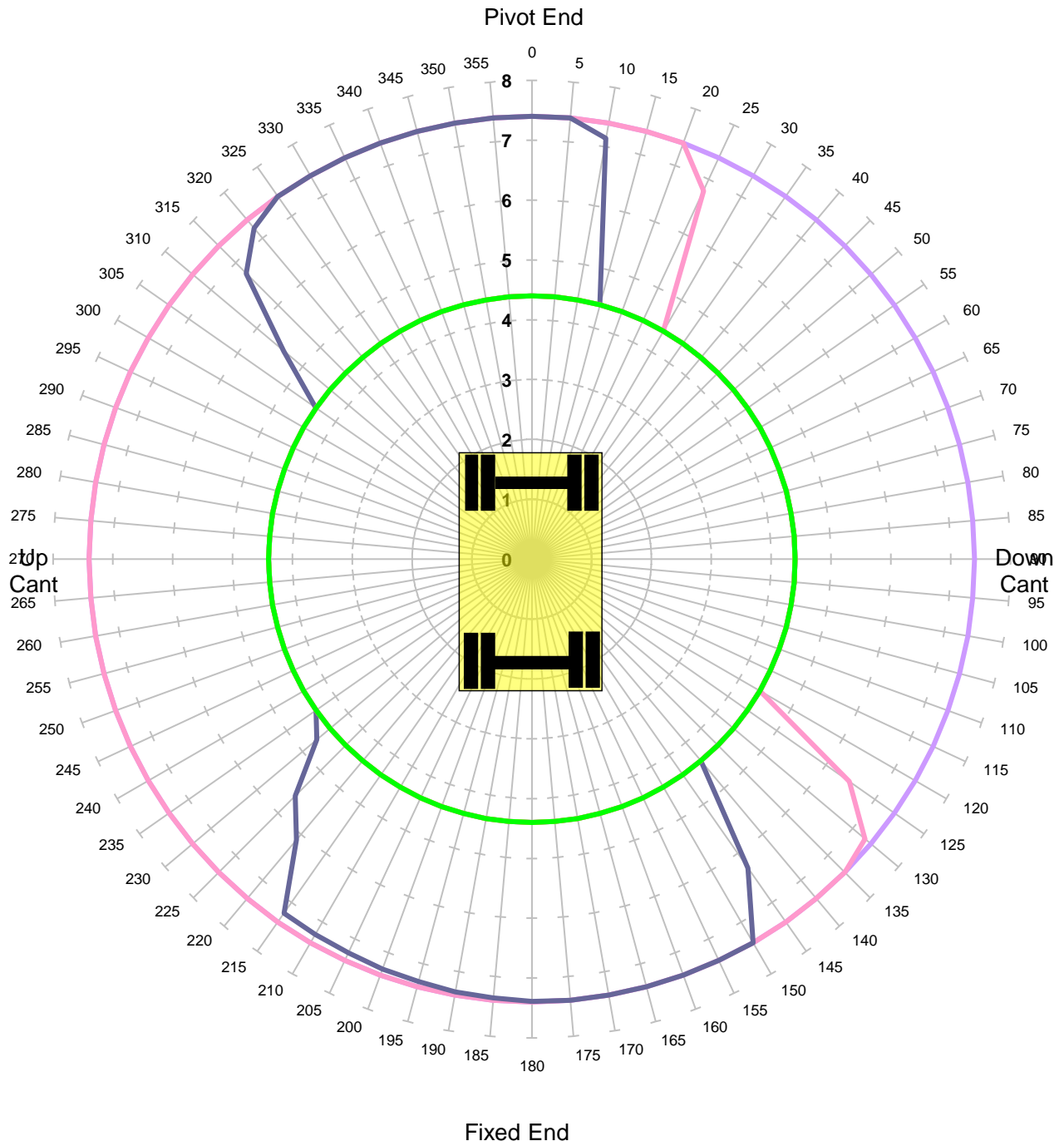

Units in Tonnes

- 1
- 2
- 3
- 4
- 5
- 6
- 7

MACHINE & MODEL:	Komatsu PW160	REFERENCE:	
SERIAL No:	H55147	DATE OF CHART:	23-Jul-2020
EQUIPMENT:	5.15m + 2.10m	SAFETY FACTOR:	90.0%
COMMENT:			



KING TRANSPORT EQUIPMENT LTD

**Max Capacity Contours of Radius(m) Plots 2.1m Dipper
Gradient 1 in -25 Height 2m Lift QH**

Locked Rail Cant -50mm

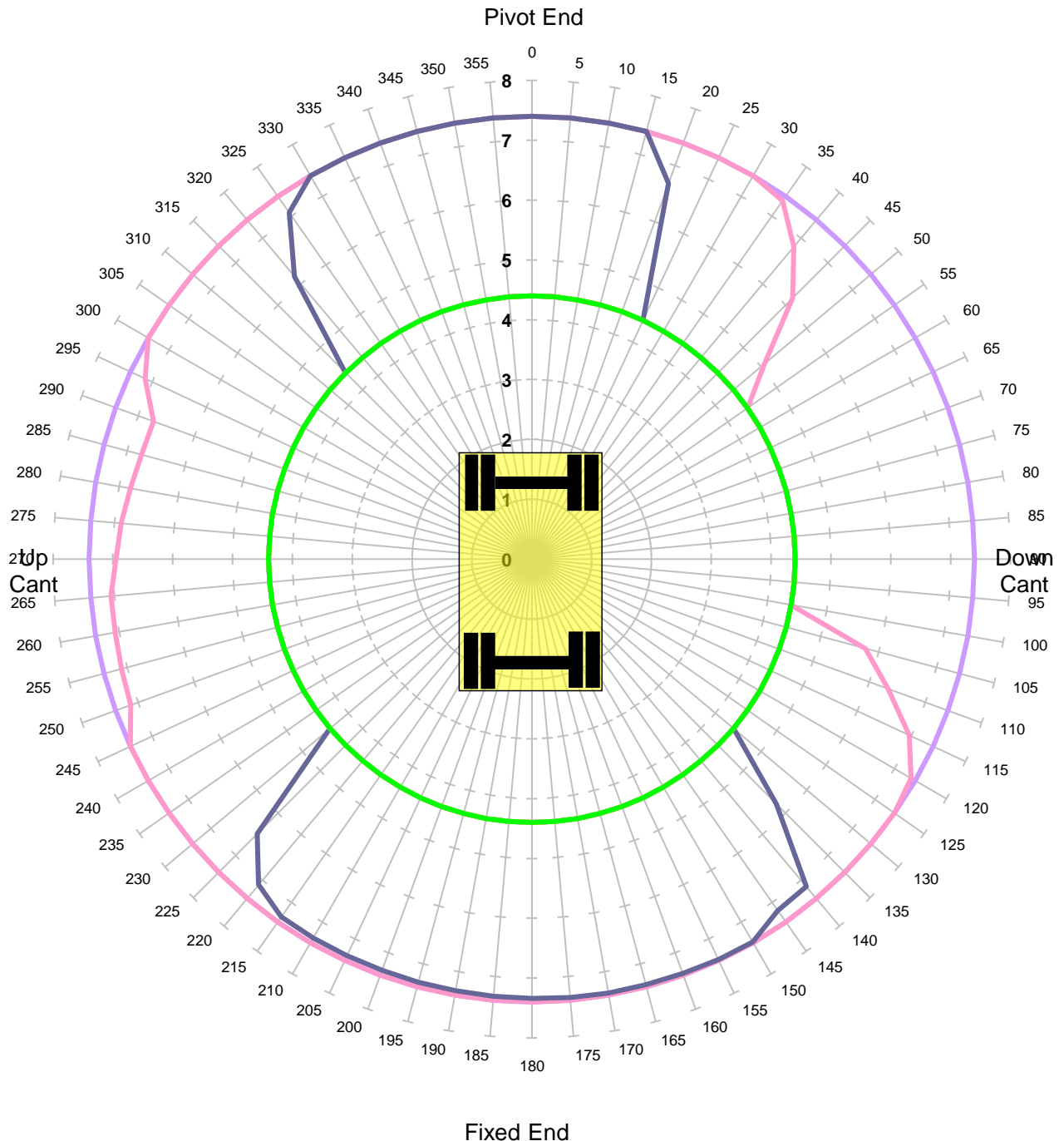

Units in Tonnes

- 1
- 2
- 3
- 4
- 5
- 6
- 7

MACHINE & MODEL:	Komatsu PW160	REFERENCE:	
SERIAL No:	H55147	DATE OF CHART:	23-Jul-2020
EQUIPMENT:	5.15m + 2.10m	SAFETY FACTOR:	90.0%
COMMENT:			



KING TRANSPORT EQUIPMENT LTD

Max Capacity Contours of Radius(m) Plots 2.1m Dipper
Gradient 1 in -25 Height 2m Lift QH

Locked Rail Cant 50mm

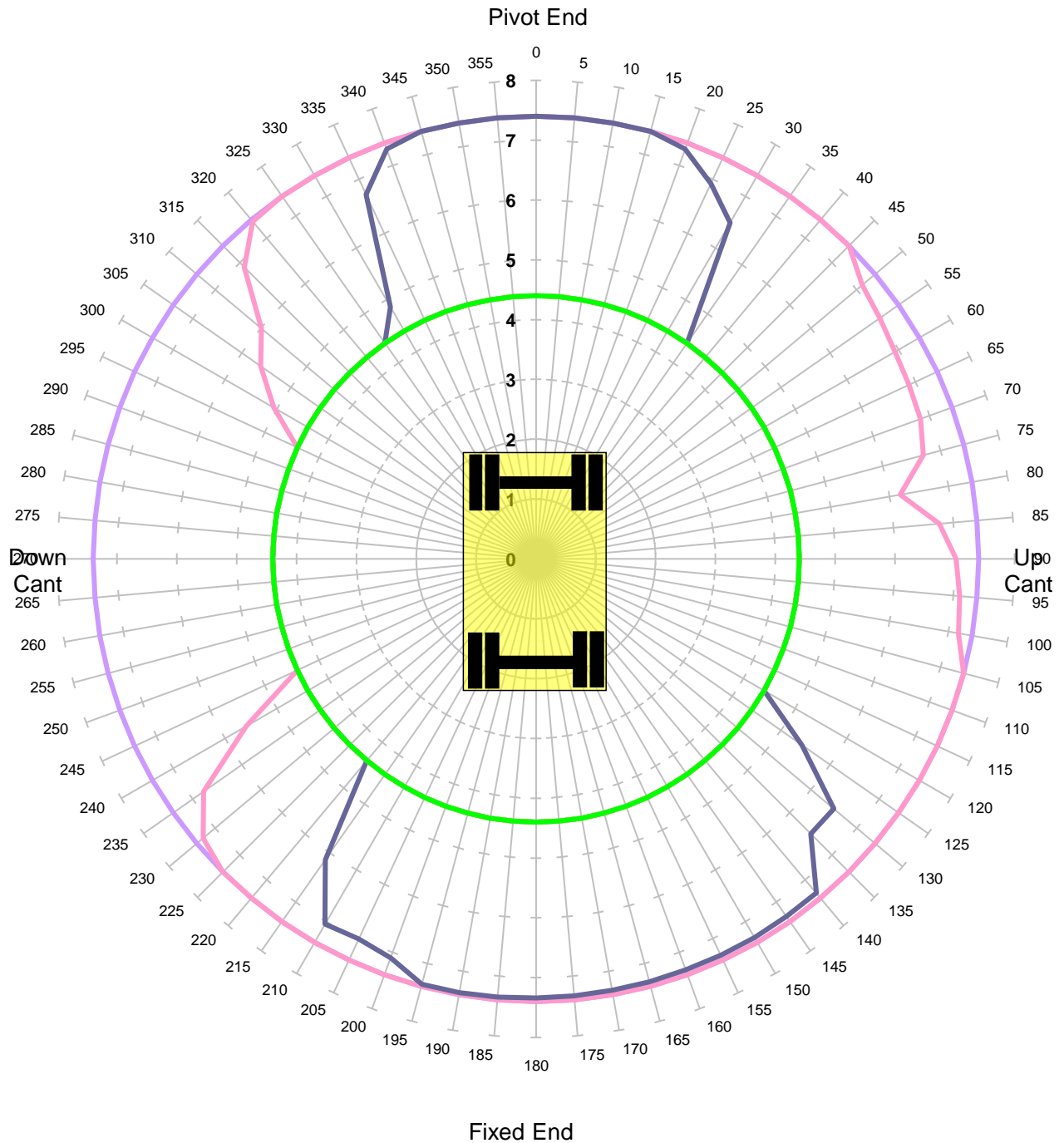

Units in Tonnes

- 1 (purple)
- 2 (pink)
- 3 (dark blue)
- 4 (light blue)
- 5 (magenta)
- 6 (yellow)
- 7 (green)

MACHINE & MODEL:	Komatsu PW160	REFERENCE:	
SERIAL No:	H55147	DATE OF CHART:	23-Jul-2020
EQUIPMENT:	5.15m + 2.10m	SAFETY FACTOR:	90.0%
COMMENT:			



KING TRANSPORT EQUIPMENT LTD

**Max Capacity Contours of Radius(m) Plots 2.1m Dipper
Gradient 1 in -25 Height 2m Lift QH**

Locked Rail Cant 150mm

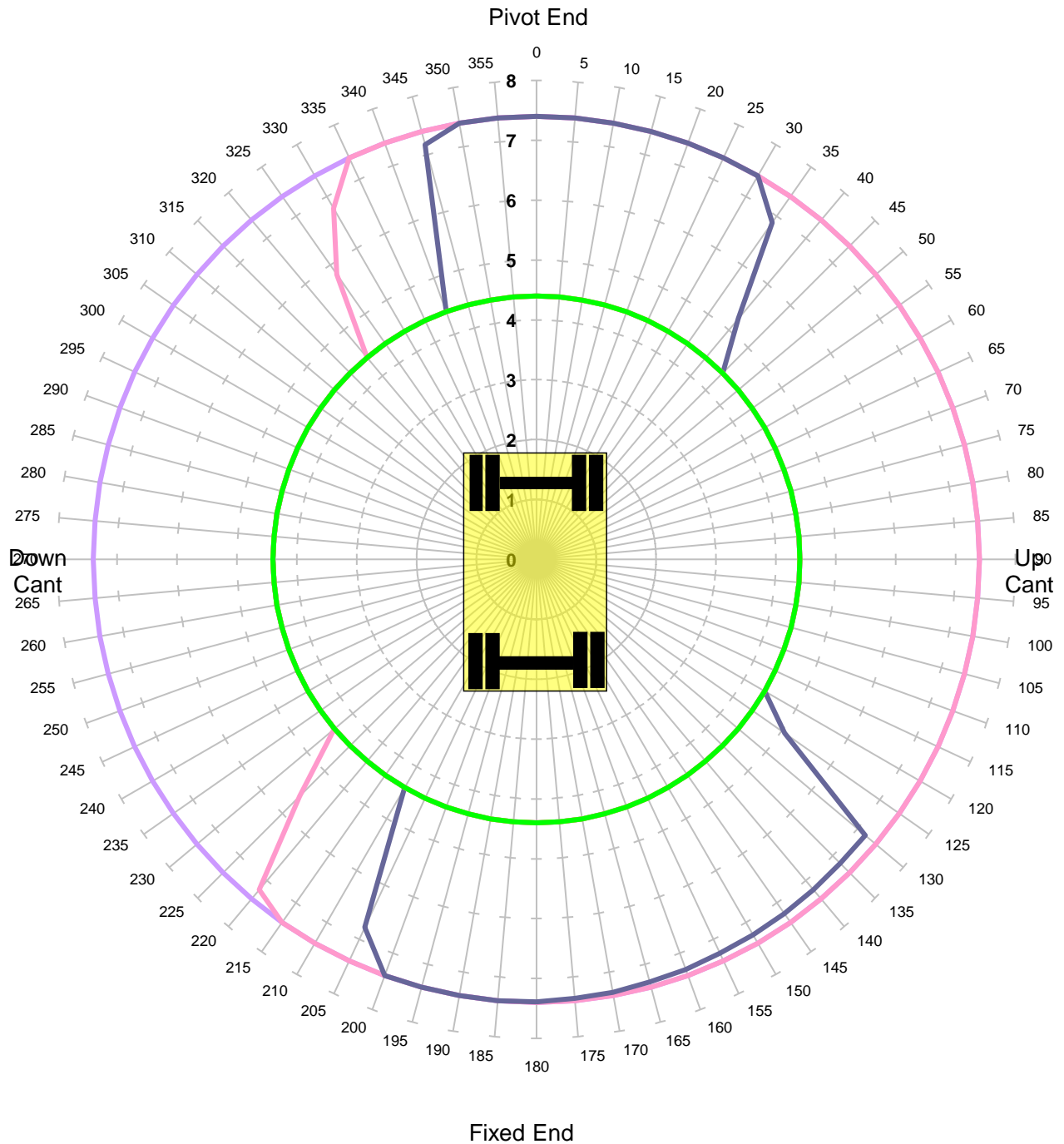

Units in Tonnes

- 1
- 2
- 3
- 4
- 5
- 6
- 7

MACHINE & MODEL:	Komatsu PW160	REFERENCE:	
SERIAL No:	H55147	DATE OF CHART:	23-Jul-2020
EQUIPMENT:	5.15m + 2.10m	SAFETY FACTOR:	90.0%
COMMENT:			



KING TRANSPORT EQUIPMENT LTD

**Max Capacity Contours of Radius(m) Plots 2.1m Dipper
Level Ground Height 2m Lift QH**

Unlocked Road

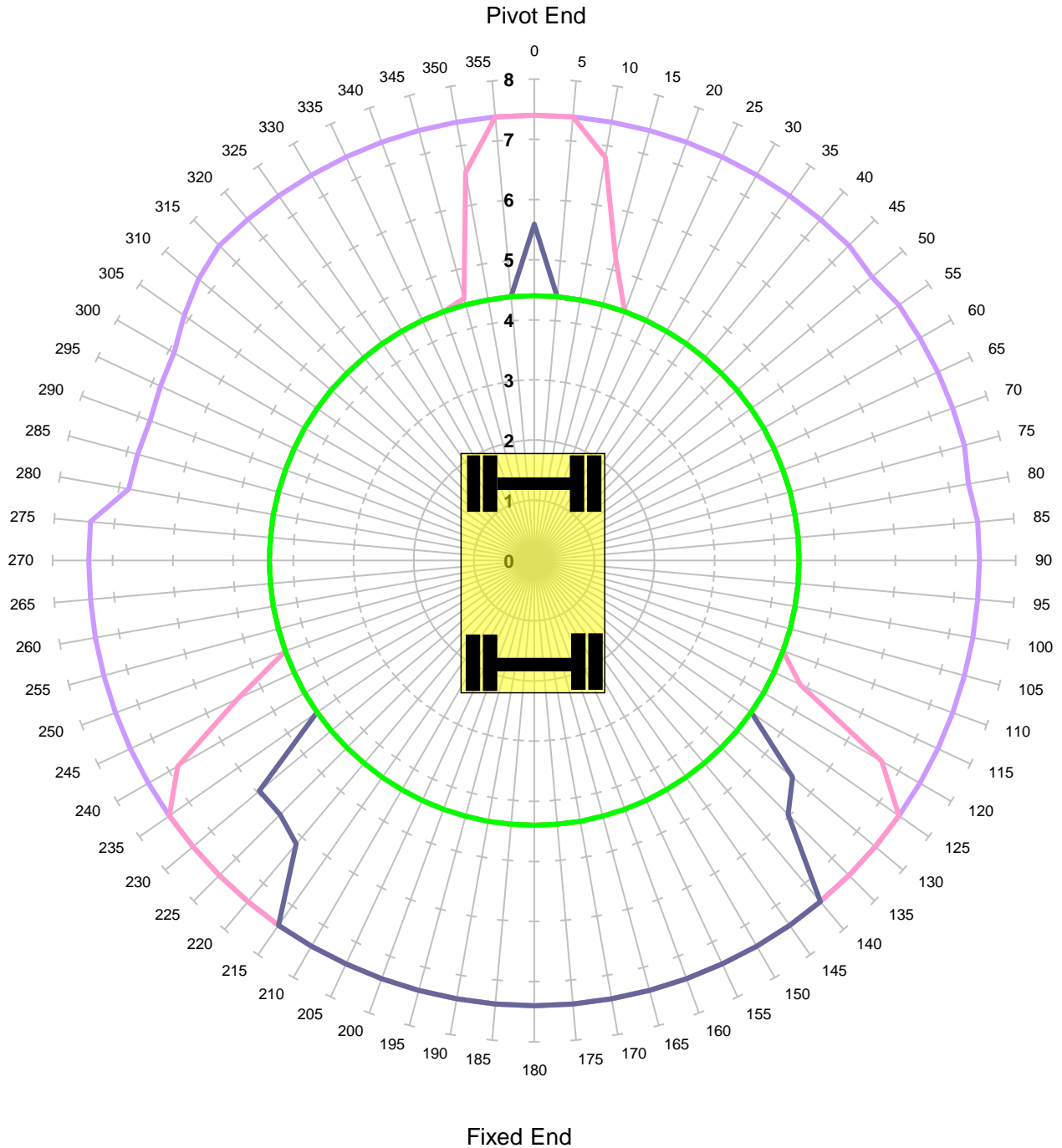

Units in Tonnes

- 1
- 2
- 3
- 4
- 5
- 6
- 7

MACHINE & MODEL:	Komatsu PW160	REFERENCE:	
SERIAL No:	H55147	DATE OF CHART:	23-Jul-2020
EQUIPMENT:	5.15m + 2.10m	SAFETY FACTOR:	71.0%
COMMENT:			



KING TRANSPORT EQUIPMENT LTD

**Max Capacity Contours of Radius(m) Plots 2.1m Dipper
Level Ground Height 2m Lift QH**

Locked Road

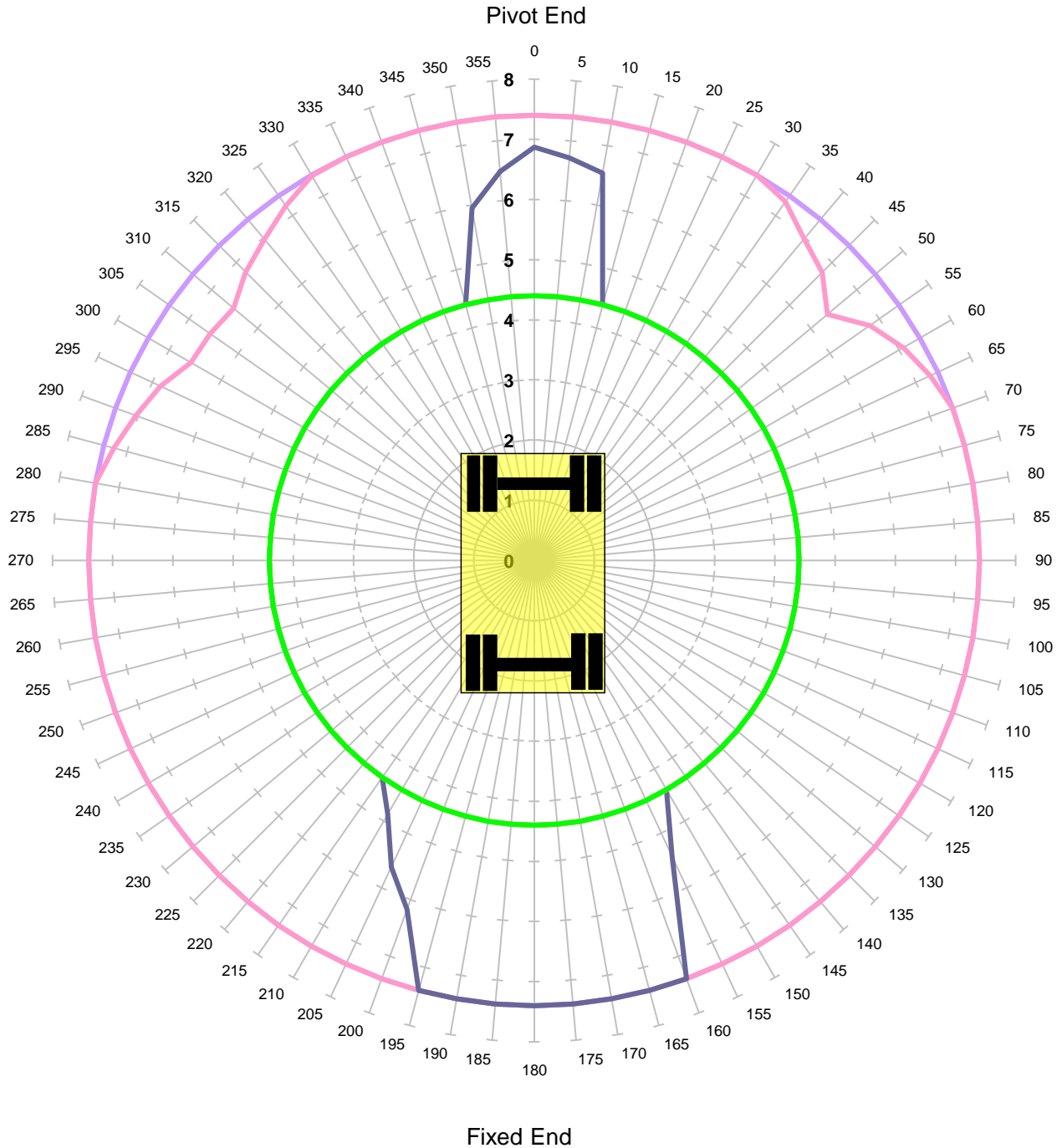

Units in Tonnes

- 1
- 2
- 3
- 4
- 5
- 6
- 7

MACHINE & MODEL:	Komatsu PW160	REFERENCE:	
SERIAL No:	H55147	DATE OF CHART:	23-Jul-2020
EQUIPMENT:	5.15m + 2.10m	SAFETY FACTOR:	71.0%
COMMENT:			



KING TRANSPORT EQUIPMENT LTD

**Max Capacity Contours of Radius(m) Plots 2.1m Dipper
Gradient 1 in -25 Height 2m Lift QH**

Unlocked Rail Cant -150mm - Tandem Lift

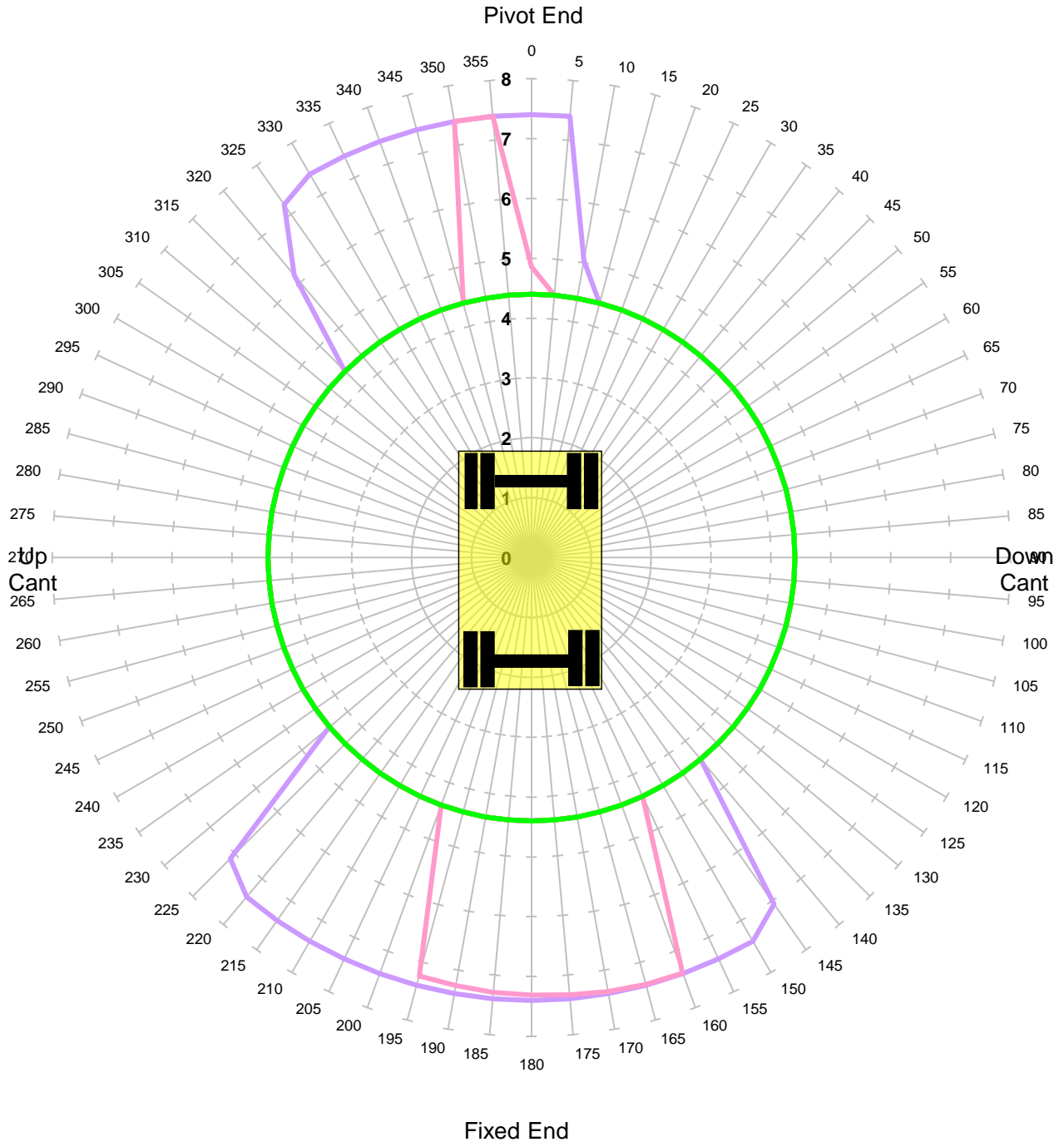

Units in Tonnes

- 1
- 2
- 3
- 4
- 5
- 6
- 7

MACHINE & MODEL:	Komatsu PW160	REFERENCE:	
SERIAL No:	H55147	DATE OF CHART:	23-Jul-2020
EQUIPMENT:	5.15m + 2.10m	SAFETY FACTOR:	44.0%
COMMENT:			



KING TRANSPORT EQUIPMENT LTD

**Max Capacity Contours of Radius(m) Plots 2.1m Dipper
Gradient 1 in -25 Height 2m Lift QH**

Unlocked Rail Cant -50mm - Tandem Lift

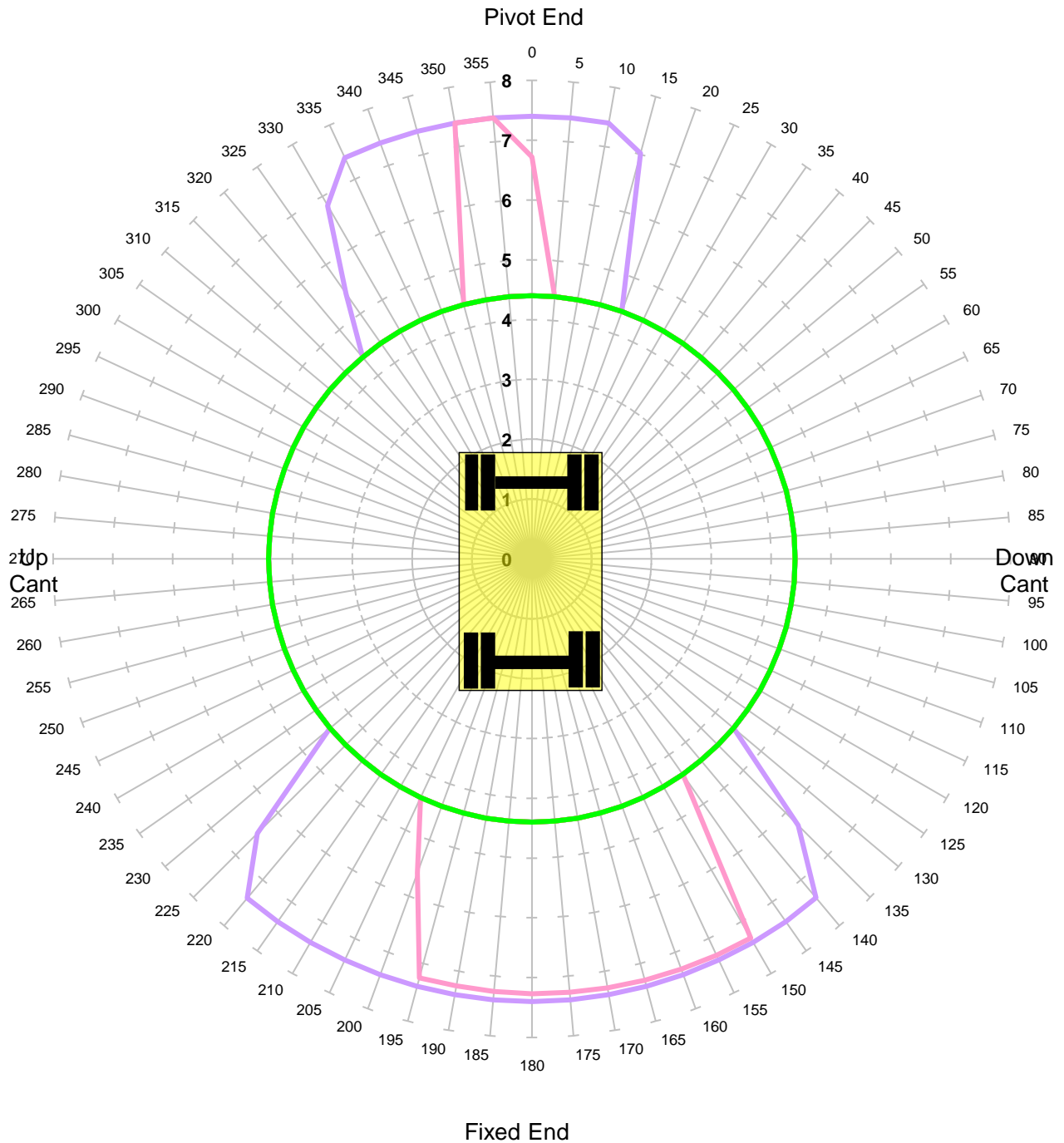

Units in Tonnes

- 1
- 2
- 3
- 4
- 5
- 6
- 7

MACHINE & MODEL:	Komatsu PW160	REFERENCE:	
SERIAL No:	H55147	DATE OF CHART:	23-Jul-2020
EQUIPMENT:	5.15m + 2.10m	SAFETY FACTOR:	44.0%
COMMENT:			



KING TRANSPORT EQUIPMENT LTD

**Max Capacity Contours of Radius(m) Plots 2.1m Dipper
Gradient 1 in -25 Height 2m Lift QH**

Unlocked Rail Cant 50mm - Tandem Lift

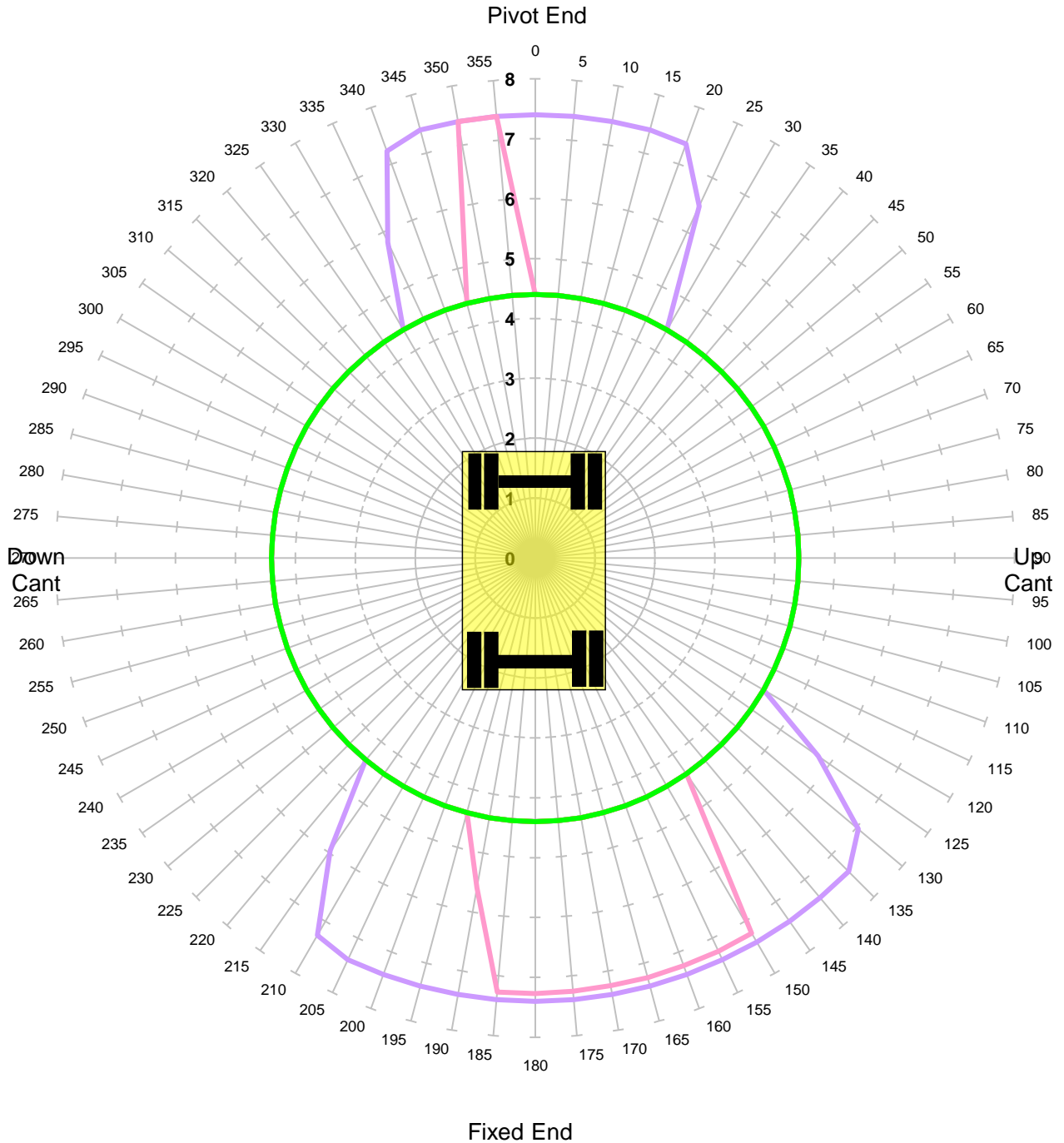

Units in Tonnes

- 1
- 2
- 3
- 4
- 5
- 6
- 7

MACHINE & MODEL:	Komatsu PW160	REFERENCE:	
SERIAL No:	H55147	DATE OF CHART:	23-Jul-2020
EQUIPMENT:	5.15m + 2.10m	SAFETY FACTOR:	44.0%
COMMENT:			



KING TRANSPORT EQUIPMENT LTD

**Max Capacity Contours of Radius(m) Plots 2.1m Dipper
Gradient 1 in -25 Height 2m Lift QH**

Unlocked Rail Cant 150mm - Tandem Lift

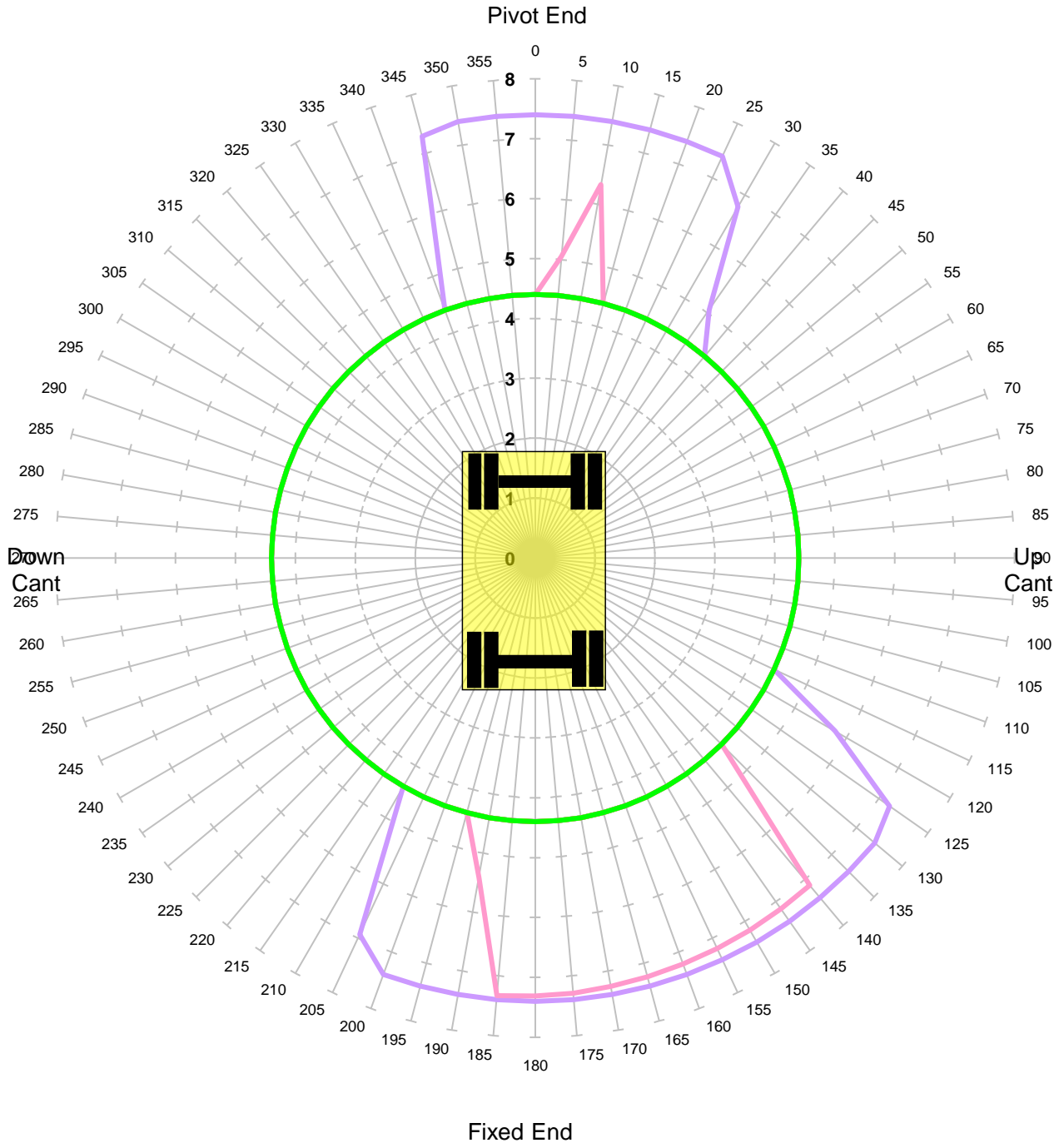

Units in Tonnes

- 1
- 2
- 3
- 4
- 5
- 6
- 7

MACHINE & MODEL:	Komatsu PW160	REFERENCE:	
SERIAL No:	H55147	DATE OF CHART:	23-Jul-2020
EQUIPMENT:	5.15m + 2.10m	SAFETY FACTOR:	44.0%
COMMENT:			



KING TRANSPORT EQUIPMENT LTD

**Max Capacity Contours of Radius(m) Plots 2.1m Dipper
Gradient 1 in -25 Height 2m Lift QH**

Locked Rail Cant -150mm - Tandem Lift

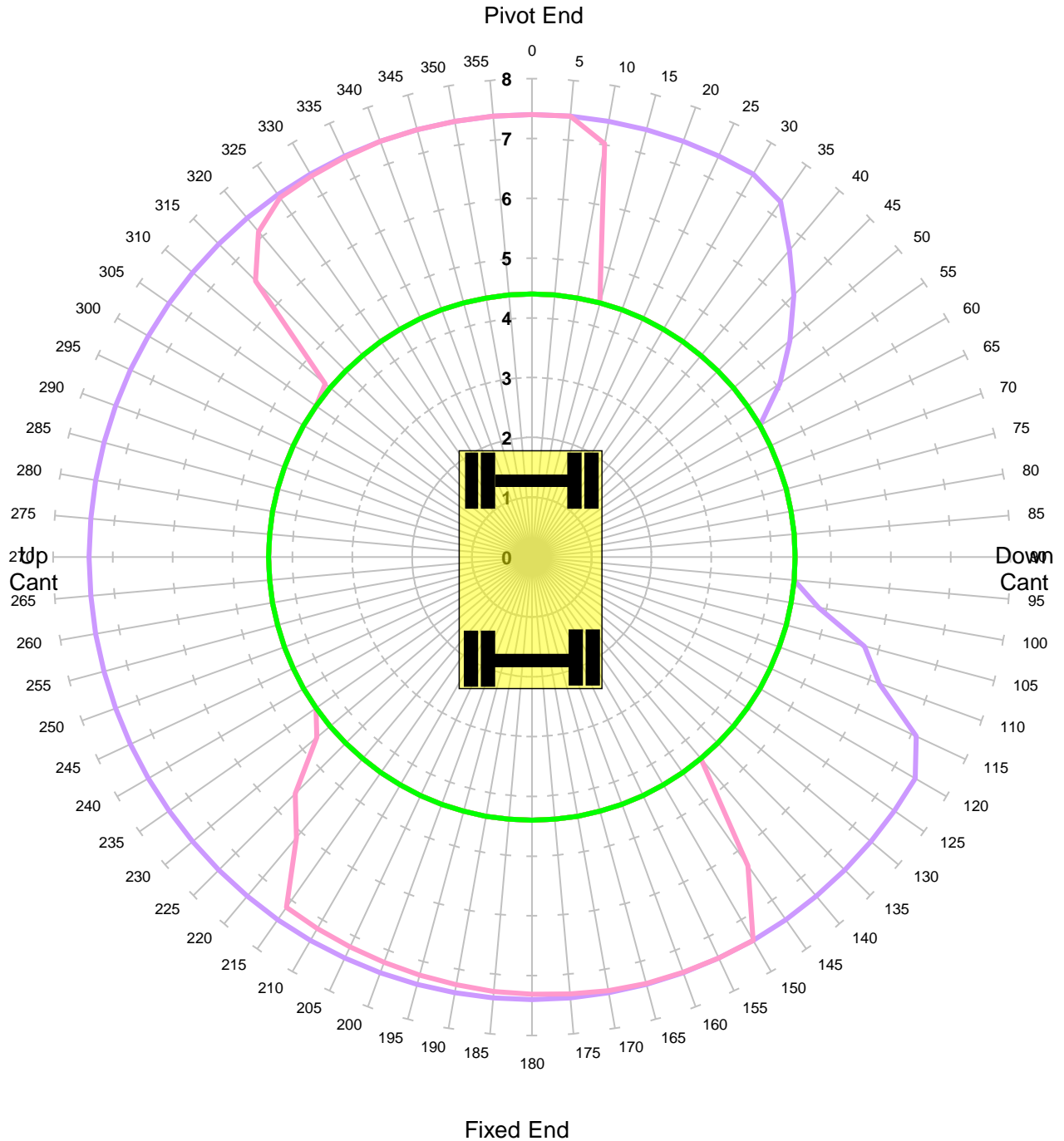

Units in Tonnes

- 1
- 2
- 3
- 4
- 5
- 6
- 7

MACHINE & MODEL:	Komatsu PW160	REFERENCE:	
SERIAL No:	H55147	DATE OF CHART:	23-Jul-2020
EQUIPMENT:	5.15m + 2.10m	SAFETY FACTOR:	59.0%
COMMENT:			



KING TRANSPORT EQUIPMENT LTD

**Max Capacity Contours of Radius(m) Plots 2.1m Dipper
Gradient 1 in -25 Height 2m Lift QH**

Locked Rail Cant -50mm - Tandem Lift

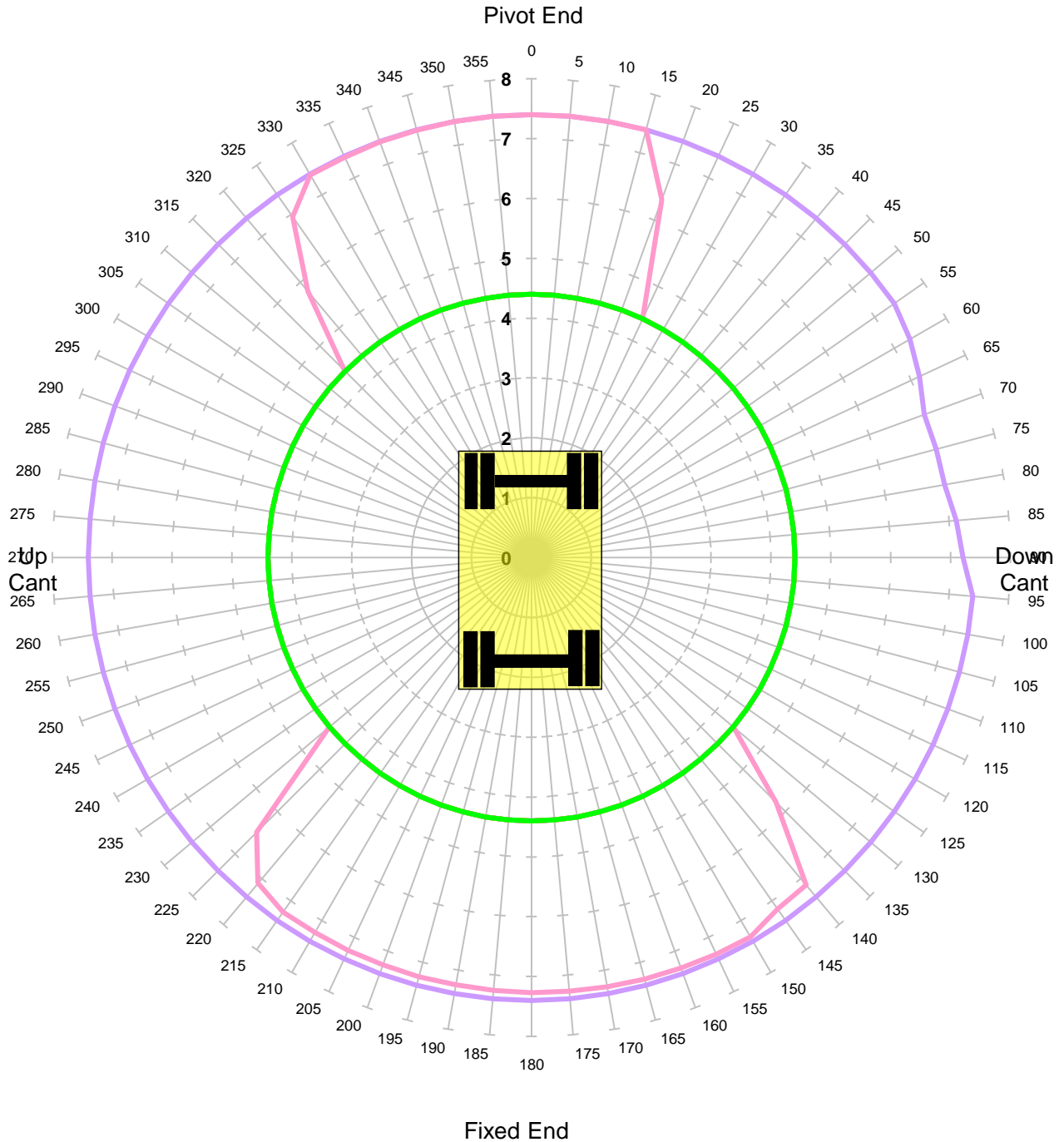

Units in Tonnes

- 1
- 2
- 3
- 4
- 5
- 6
- 7

MACHINE & MODEL:	Komatsu PW160	REFERENCE:	
SERIAL No:	H55147	DATE OF CHART:	23-Jul-2020
EQUIPMENT:	5.15m + 2.10m	SAFETY FACTOR:	59.0%
COMMENT:			



KING TRANSPORT EQUIPMENT LTD

**Max Capacity Contours of Radius(m) Plots 2.1m Dipper
Gradient 1 in -25 Height 2m Lift QH**

Locked Rail Cant 50mm - Tandem Lift

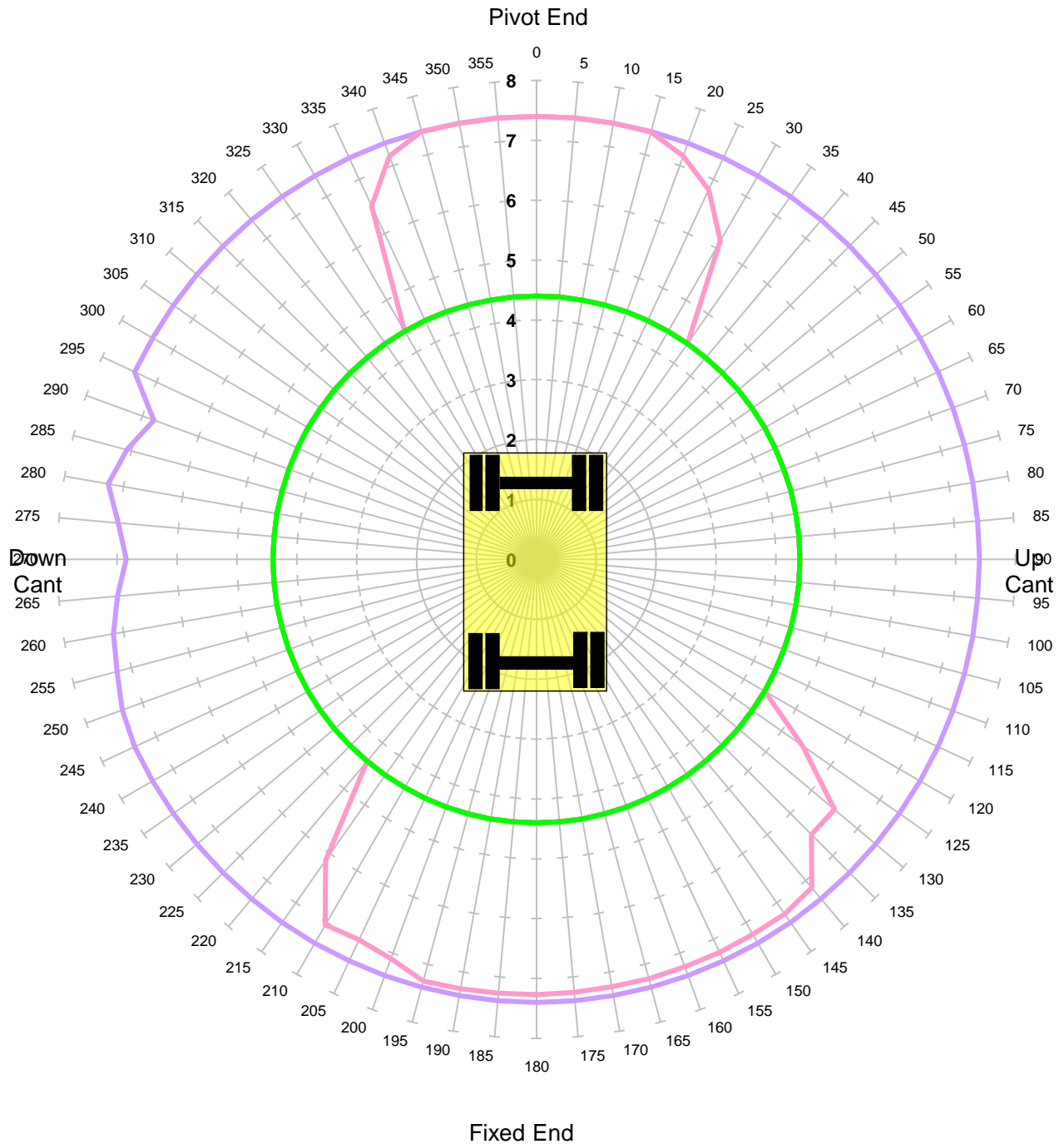

Units in Tonnes

- 1
- 2
- 3
- 4
- 5
- 6
- 7

MACHINE & MODEL:	Komatsu PW160	REFERENCE:	
SERIAL No:	H55147	DATE OF CHART:	23-Jul-2020
EQUIPMENT:	5.15m + 2.10m	SAFETY FACTOR:	59.0%
COMMENT:			



KING TRANSPORT EQUIPMENT LTD

**Max Capacity Contours of Radius(m) Plots 2.1m Dipper
Gradient 1 in -25 Height 2m Lift QH**

Locked Rail Cant 150mm - Tandem Lift

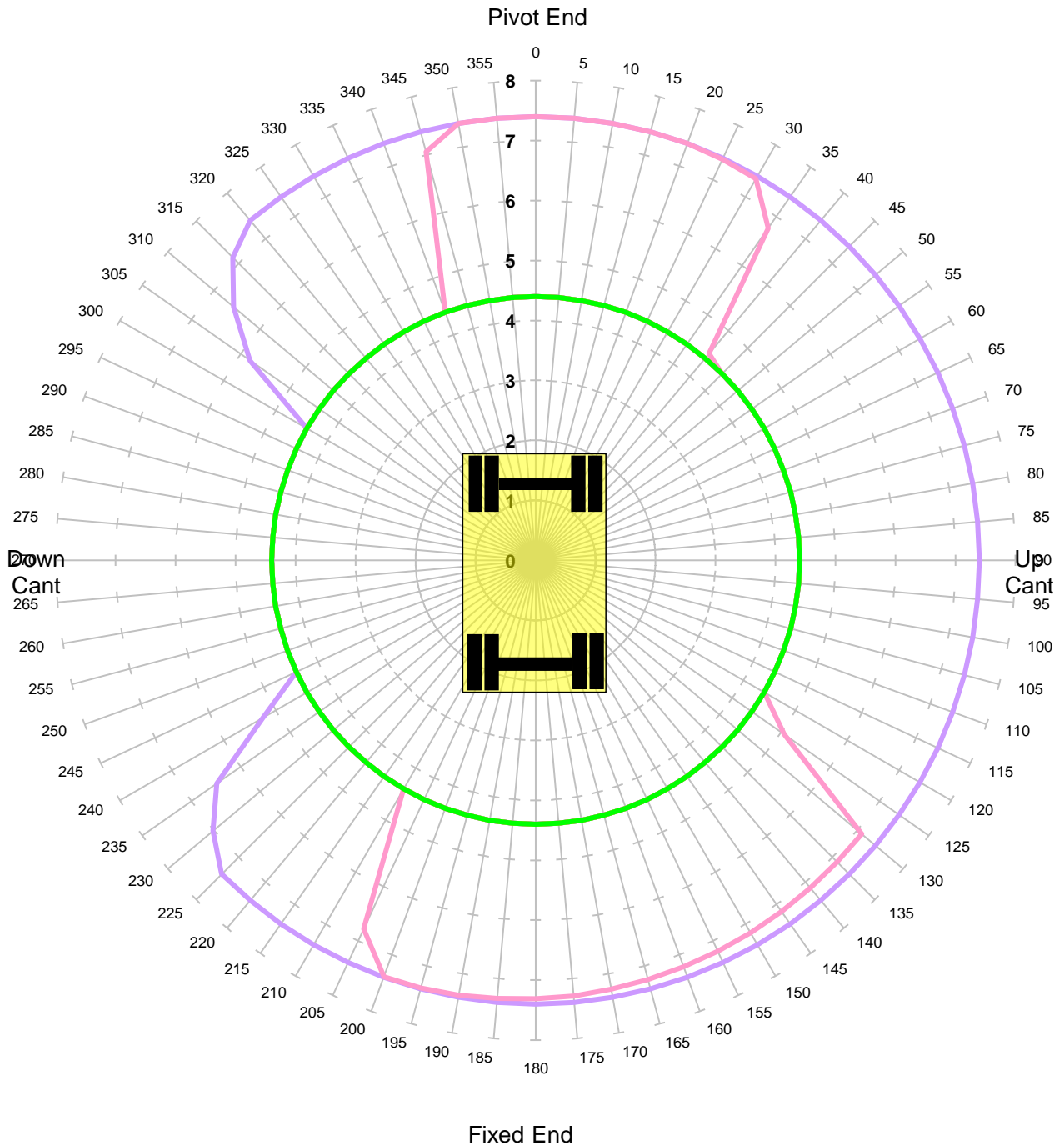

Units in Tonnes

- 1
- 2
- 3
- 4
- 5
- 6
- 7

MACHINE & MODEL:	Komatsu PW160	REFERENCE:	
SERIAL No:	H55147	DATE OF CHART:	23-Jul-2020
EQUIPMENT:	5.15m + 2.10m	SAFETY FACTOR:	59.0%
COMMENT:			



KING TRANSPORT EQUIPMENT LTD

**Max Capacity Contours of Radius(m) Plots 2.1m Dipper
Level Ground Height 2m Lift QH**

Unlocked Road - Tandem Lift

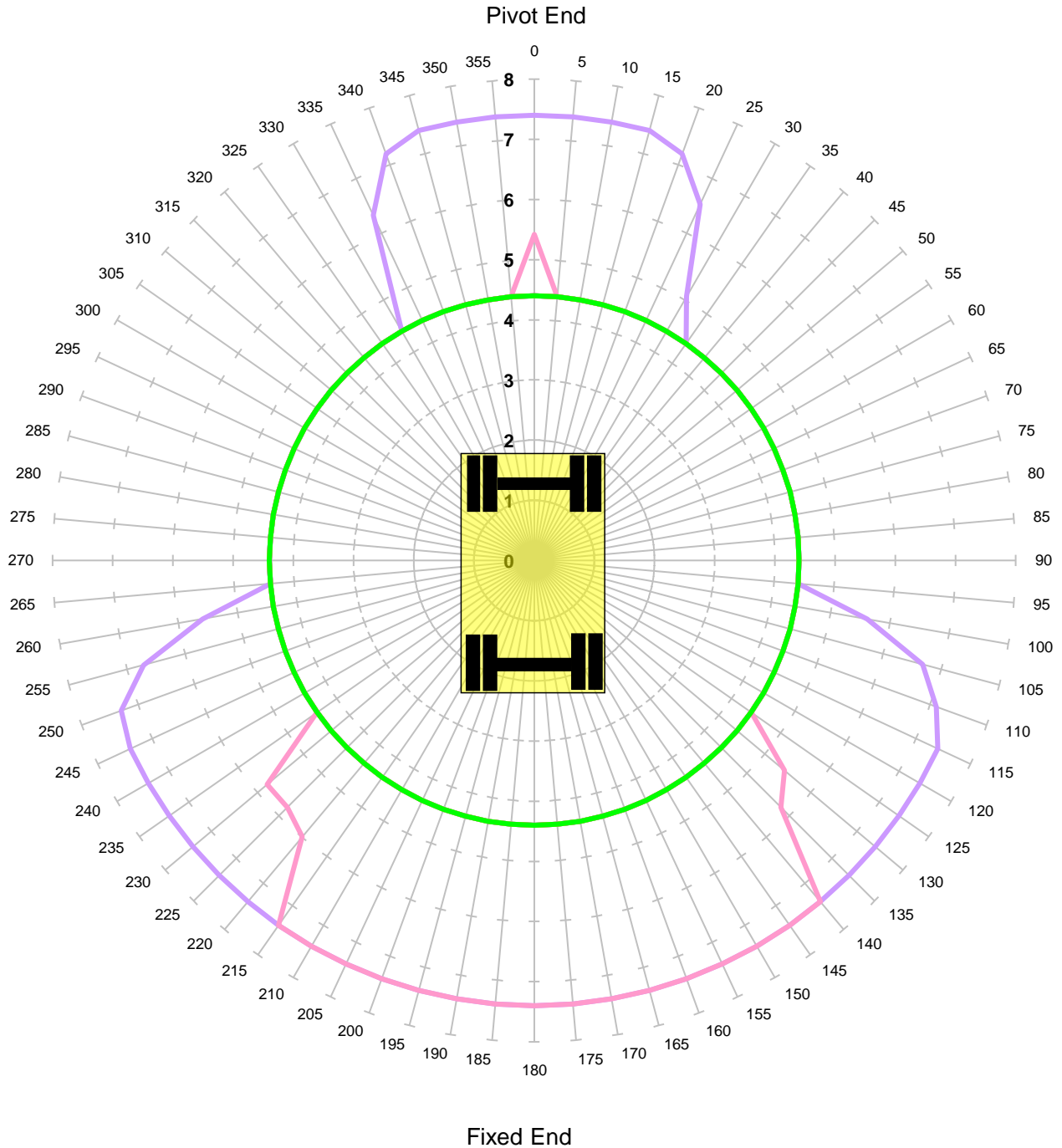

Units in Tonnes

- 1
- 2
- 3
- 4
- 5
- 6
- 7

MACHINE & MODEL:	Komatsu PW160	REFERENCE:	
SERIAL No:	H55147	DATE OF CHART:	23-Jul-2020
EQUIPMENT:	5.15m + 2.10m	SAFETY FACTOR:	47.0%
COMMENT:			



KING TRANSPORT EQUIPMENT LTD

**Max Capacity Contours of Radius(m) Plots 2.1m Dipper
Level Ground Height 2m Lift QH**

Locked Road - Tandem Lift

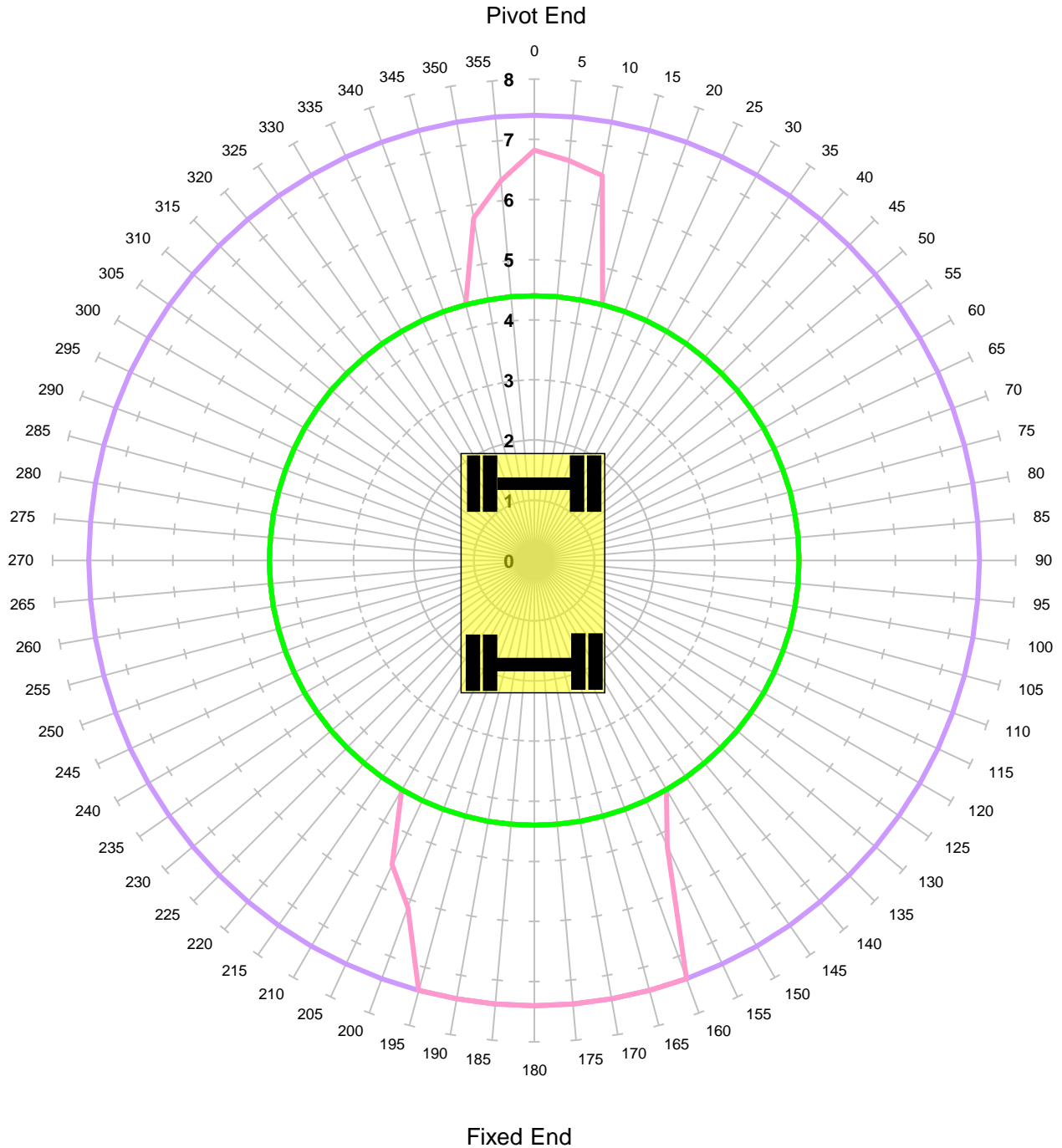

Units in Tonnes

- 1
- 2
- 3
- 4
- 5
- 6
- 7

MACHINE & MODEL:	Komatsu PW160	REFERENCE:	
SERIAL No:	H55147	DATE OF CHART:	23-Jul-2020
EQUIPMENT:	5.15m + 2.10m	SAFETY FACTOR:	47.0%
COMMENT:			