

**Komatsu PW160-11**  
**Max Capacity Contours of Radius(m) Plots 2.5m Dipper**  
**Gradient 1 in -25 Height 2m Lift BP**  
**Unlocked Rail Cant -150mm**

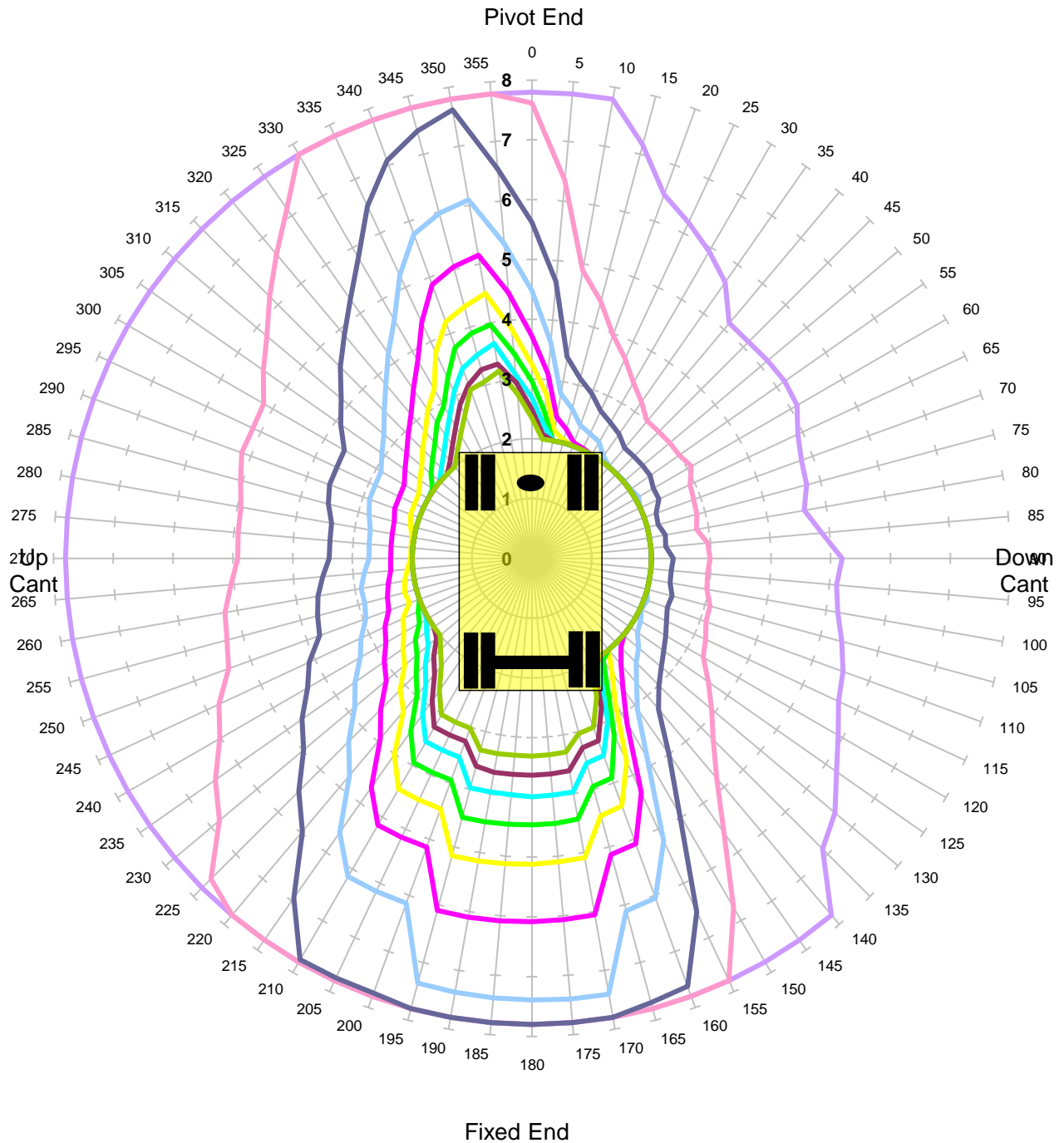

Units in Tonnes

- 1
- 2
- 3
- 4
- 5
- 6
- 7
- 8
- 9
- 10

<b>MACHINE &amp; MODEL:</b>	Komatsu PW160-11	<b>REFERENCE:</b>	3.00m Jib
<b>SERIAL No:</b>	H65234	<b>DATE OF CHART:</b>	12-Oct-2020
<b>EQUIPMENT:</b>	2.00m + 3.47m + 2.50m	<b>SAFETY FACTOR:</b>	67.0%
<b>COMMENT:</b>			

**Komatsu PW160-11**  
**Max Capacity Contours of Radius(m) Plots 2.5m Dipper**  
**Gradient 1 in -25 Height 2m Lift BP**  
**Unlocked Rail Cant -50mm**

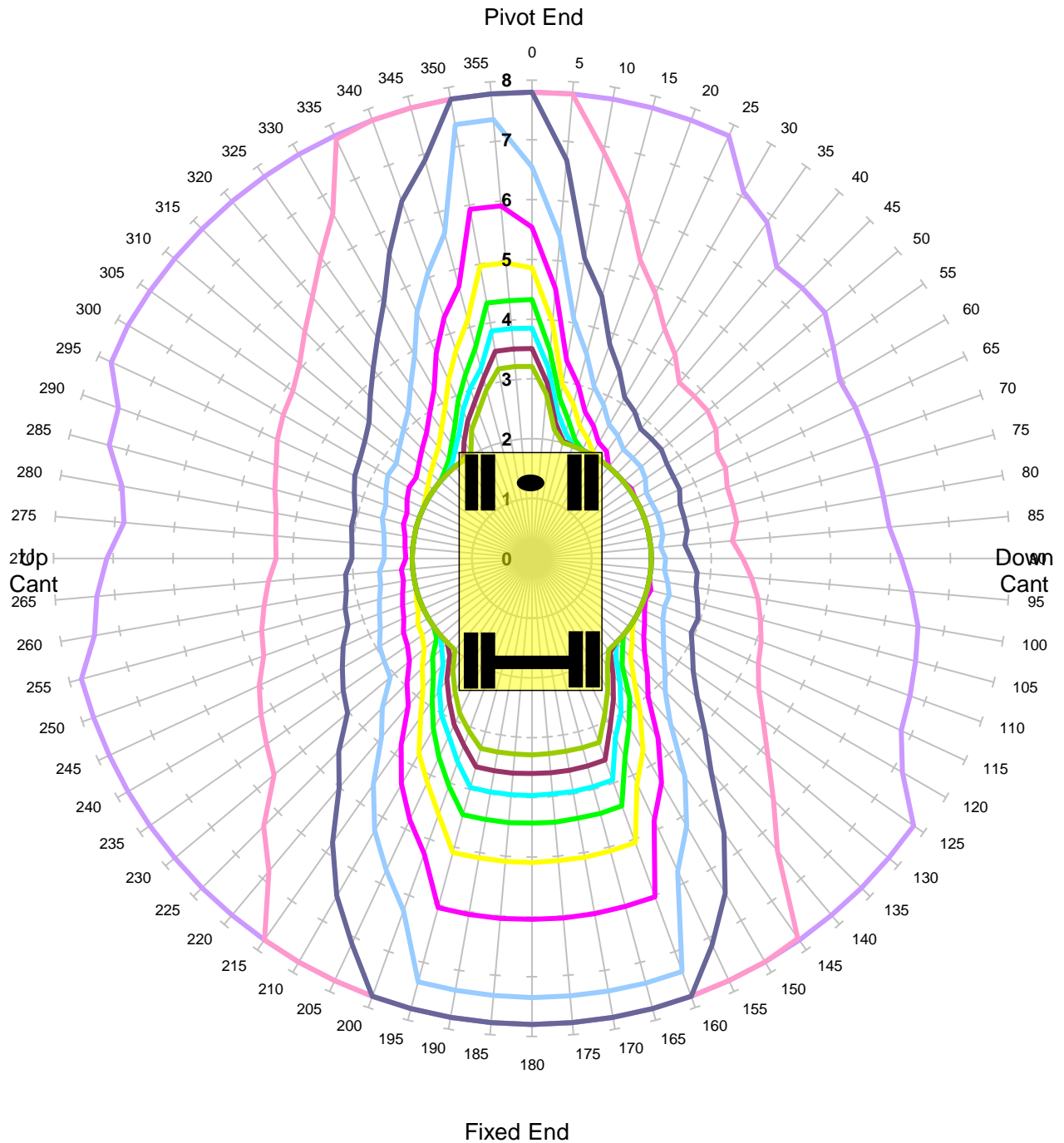

Units in Tonnes

- 1
- 2
- 3
- 4
- 5
- 6
- 7
- 8
- 9
- 10

<b>MACHINE &amp; MODEL:</b>	Komatsu PW160-11	<b>REFERENCE:</b>	3.00m Jib
<b>SERIAL No:</b>	H65234	<b>DATE OF CHART:</b>	12-Oct-2020
<b>EQUIPMENT:</b>	2.00m + 3.47m + 2.50m	<b>SAFETY FACTOR:</b>	67.0%
<b>COMMENT:</b>			

**Komatsu PW160-11**  
**Max Capacity Contours of Radius(m) Plots 2.5m Dipper**  
**Gradient 1 in -25 Height 2m Lift BP**  
**Unlocked Rail Cant 50mm**

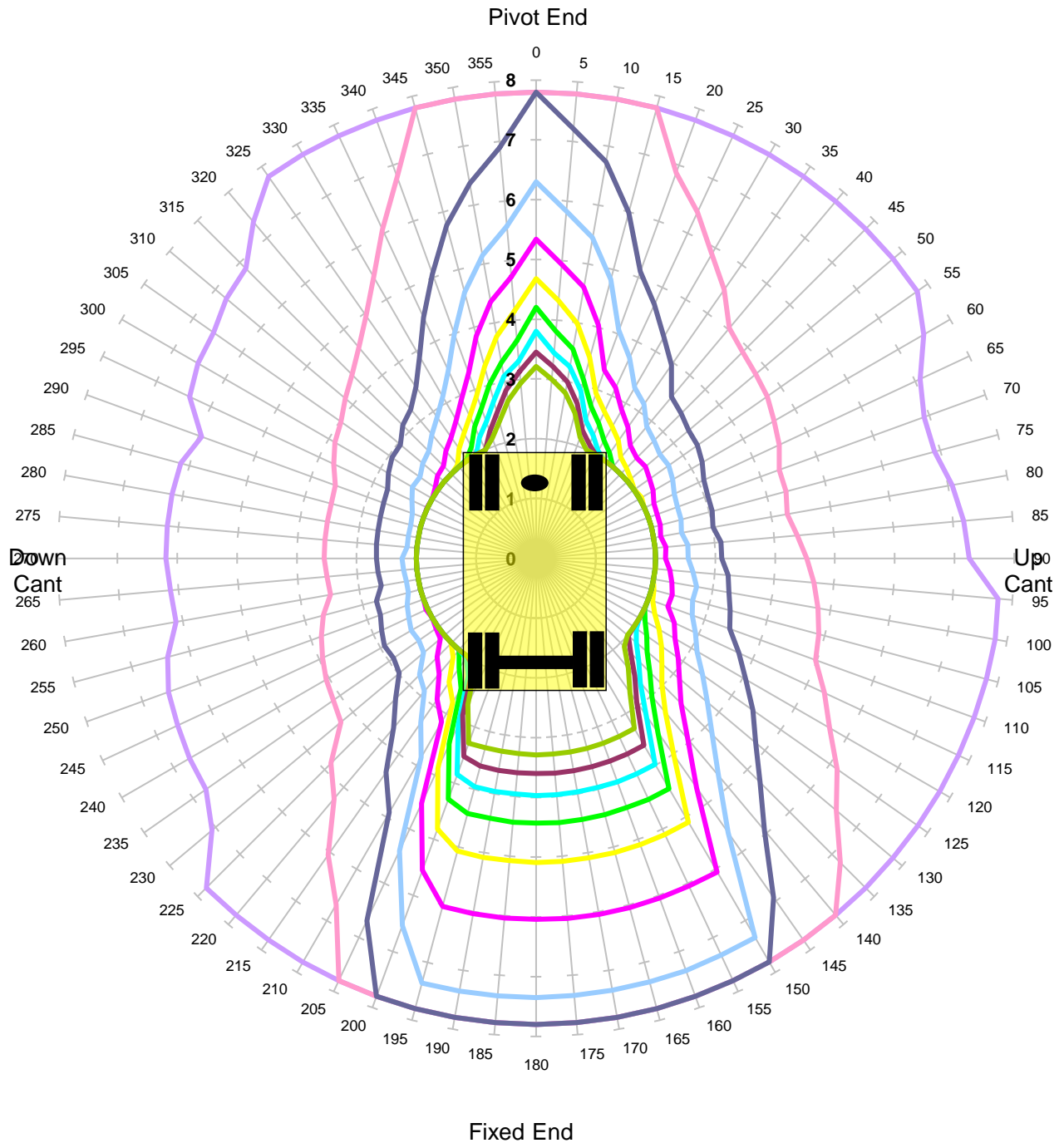

Units in Tonnes

- 1
- 2
- 3
- 4
- 5
- 6
- 7
- 8
- 9
- 10

<b>MACHINE &amp; MODEL:</b>	Komatsu PW160-11	<b>REFERENCE:</b>	3.00m Jib
<b>SERIAL No:</b>	H65234	<b>DATE OF CHART:</b>	12-Oct-2020
<b>EQUIPMENT:</b>	2.00m + 3.47m + 2.50m	<b>SAFETY FACTOR:</b>	67.0%
<b>COMMENT:</b>			

**Komatsu PW160-11**  
**Max Capacity Contours of Radius(m) Plots 2.5m Dipper**  
**Gradient 1 in -25 Height 2m Lift BP**  
**Unlocked Rail Cant 150mm**

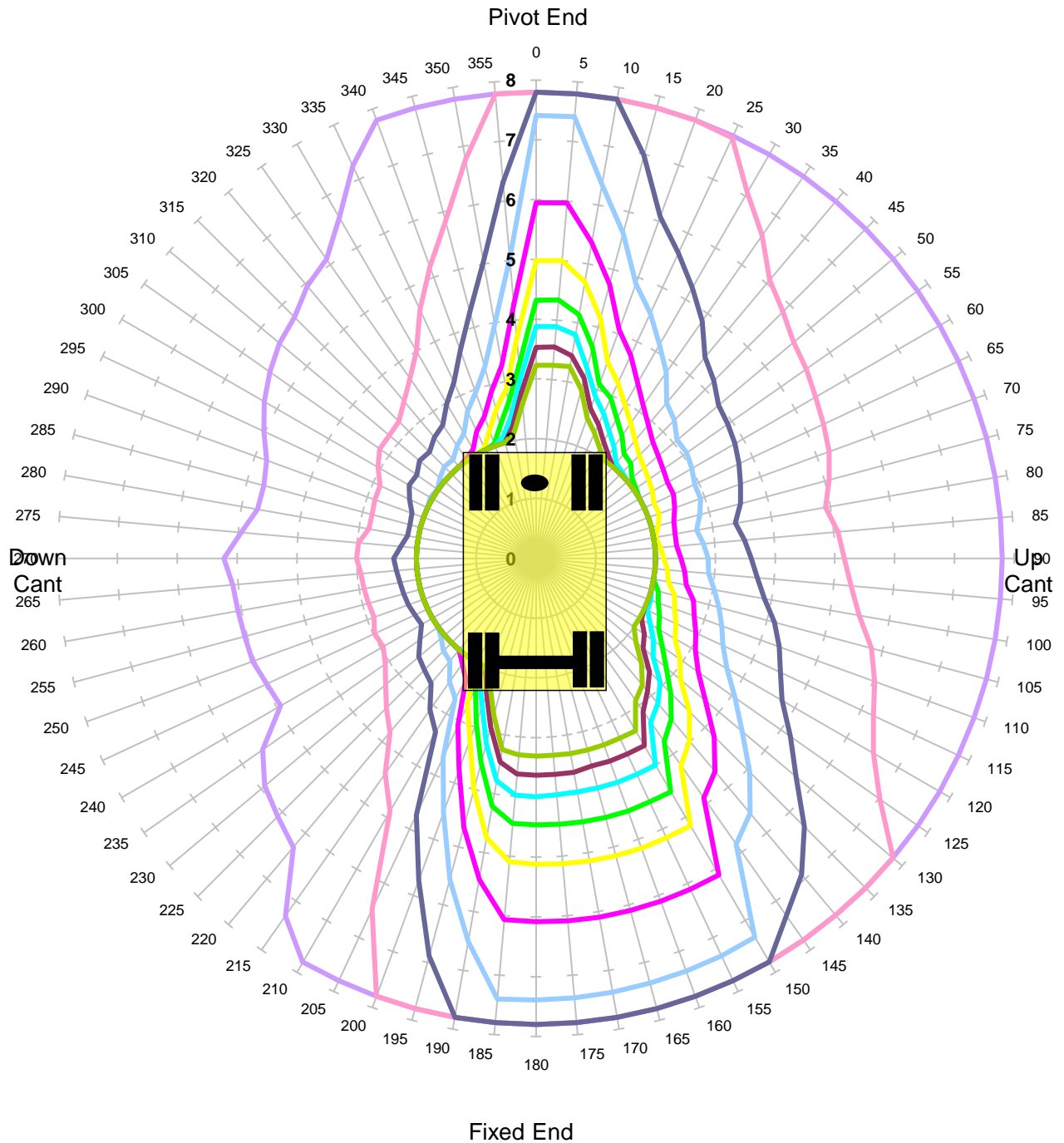

Units in Tonnes

- 1
- 2
- 3
- 4
- 5
- 6
- 7
- 8
- 9
- 10

<b>MACHINE &amp; MODEL:</b>	Komatsu PW160-11	<b>REFERENCE:</b>	3.00m Jib
<b>SERIAL No:</b>	H65234	<b>DATE OF CHART:</b>	12-Oct-2020
<b>EQUIPMENT:</b>	2.00m + 3.47m + 2.50m	<b>SAFETY FACTOR:</b>	67.0%
<b>COMMENT:</b>			

**Komatsu PW160-11**  
**Max Capacity Contours of Radius(m) Plots 2.5m Dipper**  
**Gradient 1 in -25 Height 2m Lift BP**  
**Locked Rail Cant -150mm**

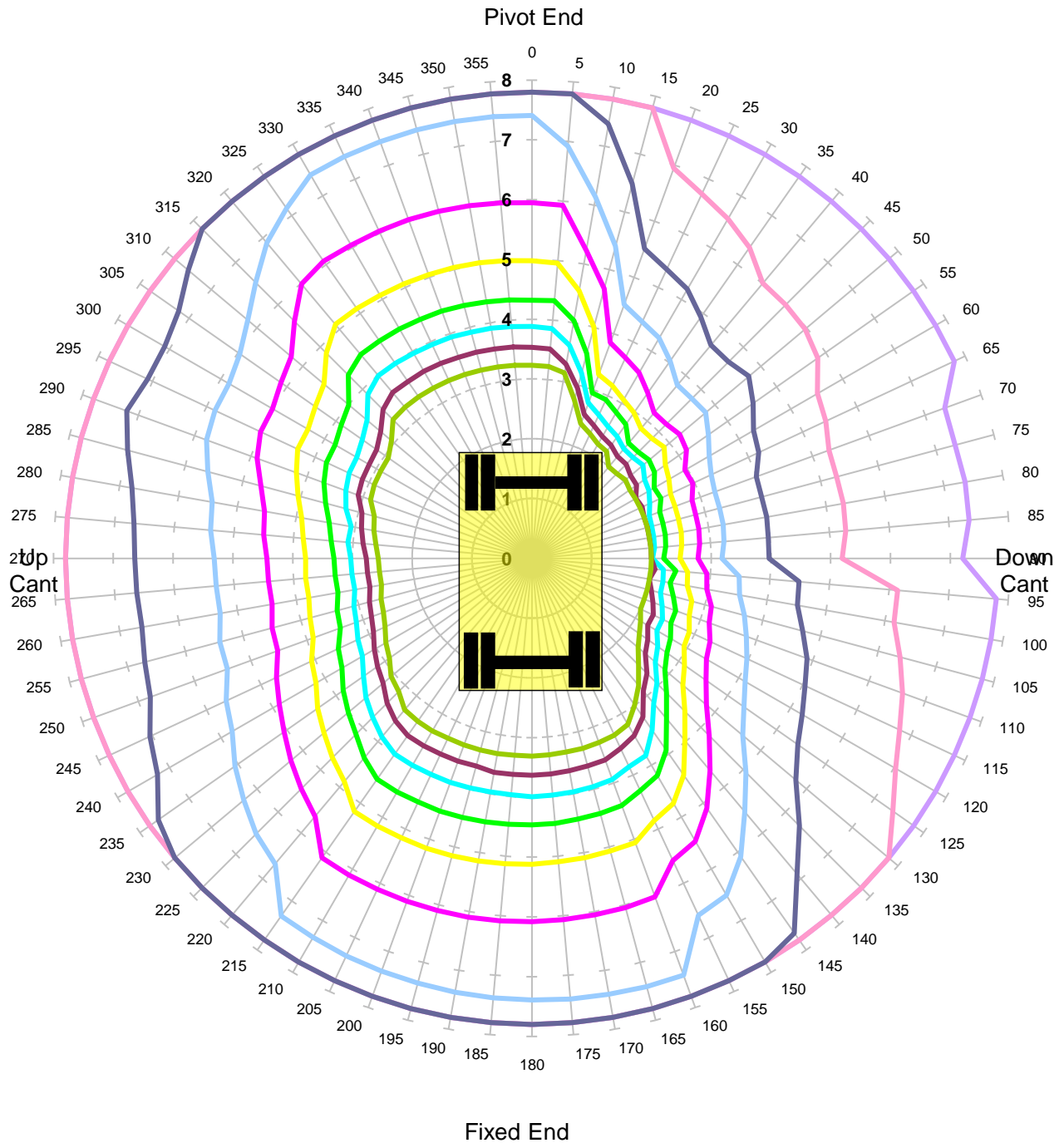

Units in Tonnes

- 1
- 2
- 3
- 4
- 5
- 6
- 7
- 8
- 9
- 10

<b>MACHINE &amp; MODEL:</b>	Komatsu PW160-11	<b>REFERENCE:</b>	3.00m Jib
<b>SERIAL No:</b>	H65234	<b>DATE OF CHART:</b>	12-Oct-2020
<b>EQUIPMENT:</b>	2.00m + 3.47m + 2.50m	<b>SAFETY FACTOR:</b>	90.0%
<b>COMMENT:</b>			

**Komatsu PW160-11**  
**Max Capacity Contours of Radius(m) Plots 2.5m Dipper**  
**Gradient 1 in -25 Height 2m Lift BP**  
**Locked Rail Cant -50mm**

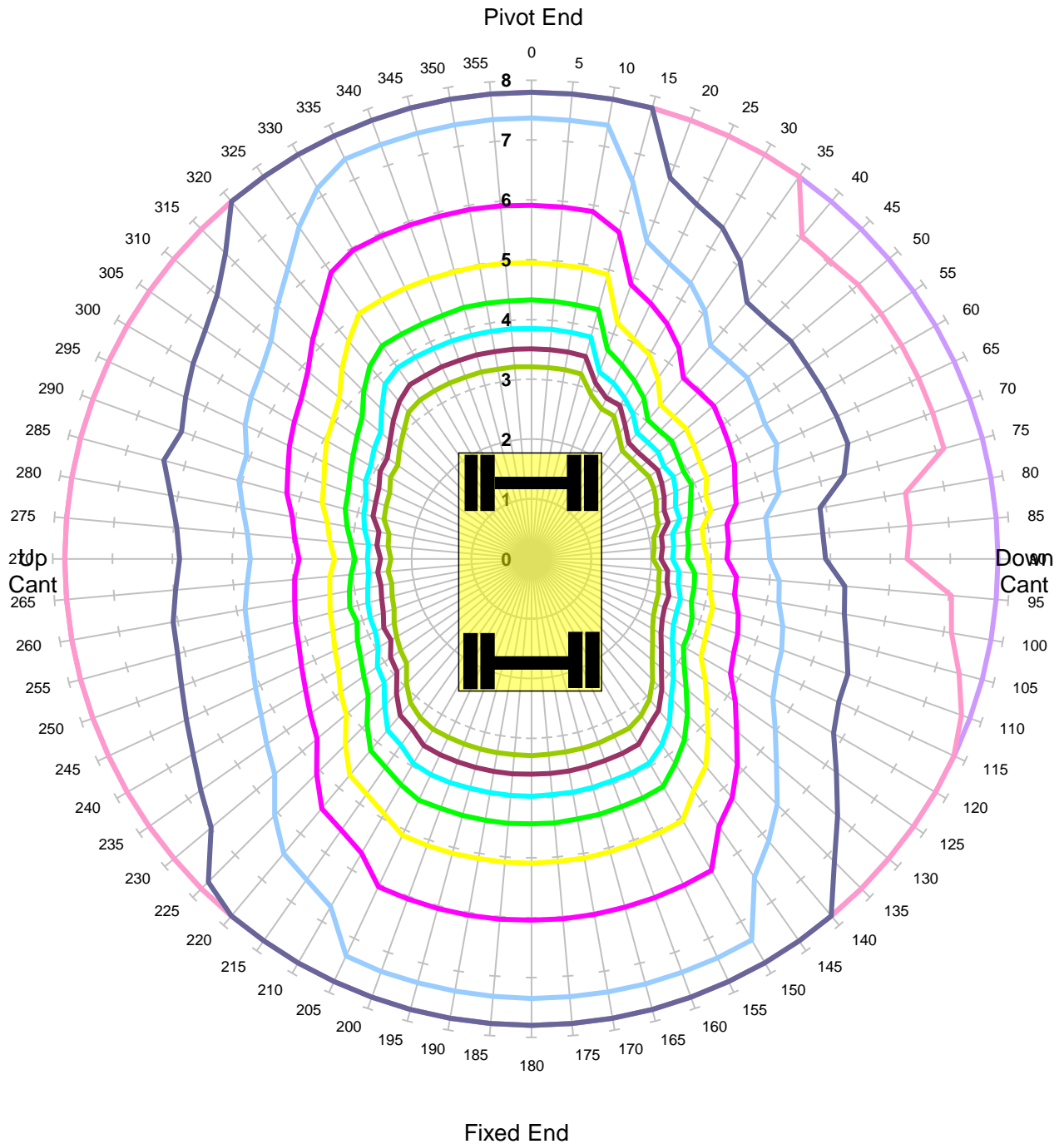

Units in Tonnes

- 1
- 2
- 3
- 4
- 5
- 6
- 7
- 8
- 9
- 10

<b>MACHINE &amp; MODEL:</b>	Komatsu PW160-11	<b>REFERENCE:</b>	3.00m Jib
<b>SERIAL No:</b>	H65234	<b>DATE OF CHART:</b>	12-Oct-2020
<b>EQUIPMENT:</b>	2.00m + 3.47m + 2.50m	<b>SAFETY FACTOR:</b>	90.0%
<b>COMMENT:</b>			



**Komatsu PW160-11**  
**Max Capacity Contours of Radius(m) Plots 2.5m Dipper**  
**Gradient 1 in -25 Height 2m Lift BP**  
**Locked Rail Cant 50mm**

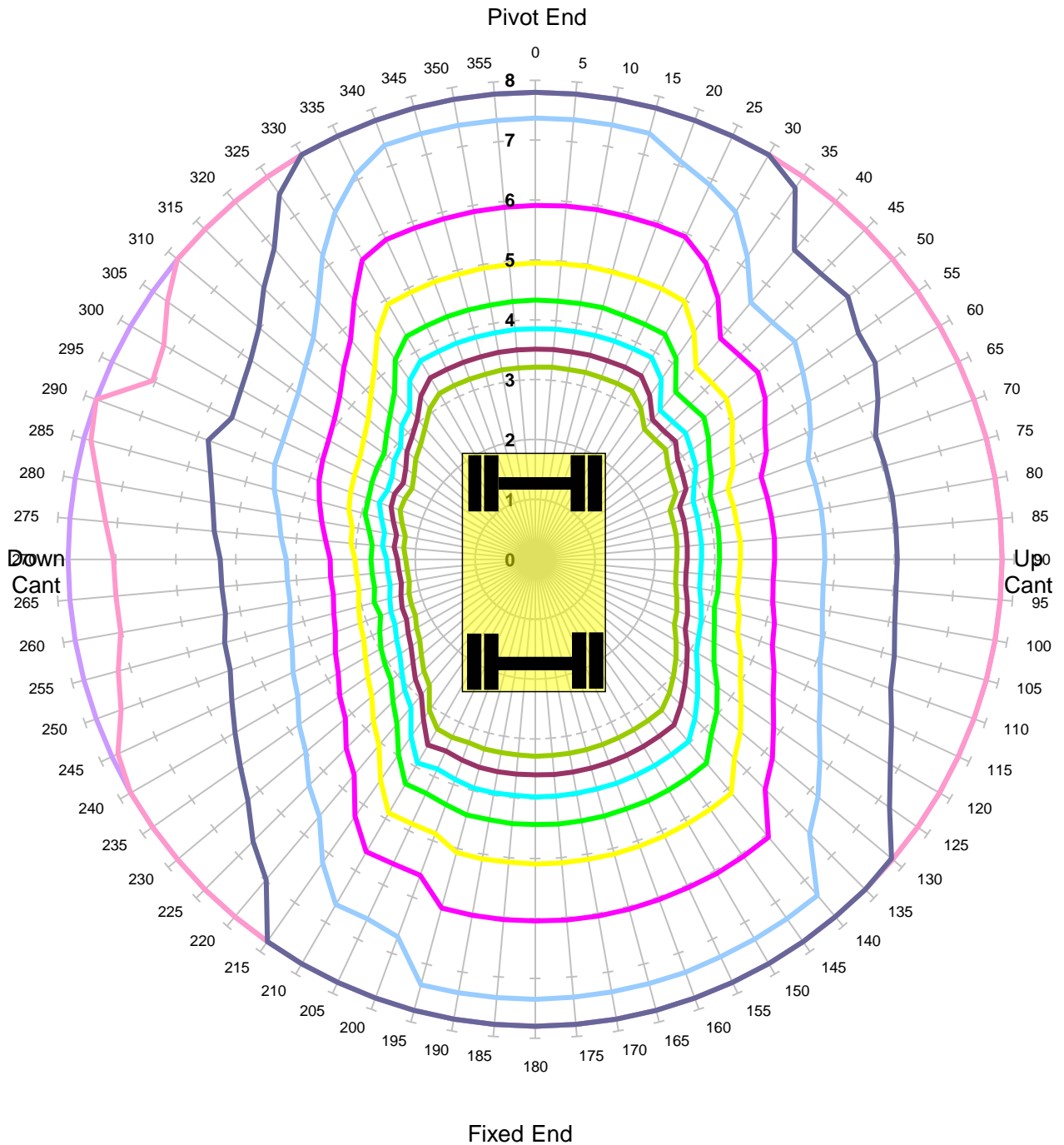

Units in Tonnes

- 1
- 2
- 3
- 4
- 5
- 6
- 7
- 8
- 9
- 10

<b>MACHINE &amp; MODEL:</b>	Komatsu PW160-11	<b>REFERENCE:</b>	3.00m Jib
<b>SERIAL No:</b>	H65234	<b>DATE OF CHART:</b>	12-Oct-2020
<b>EQUIPMENT:</b>	2.00m + 3.47m + 2.50m	<b>SAFETY FACTOR:</b>	90.0%
<b>COMMENT:</b>			

**Komatsu PW160-11**  
**Max Capacity Contours of Radius(m) Plots 2.5m Dipper**  
**Gradient 1 in -25 Height 2m Lift BP**  
**Locked Rail Cant 150mm**

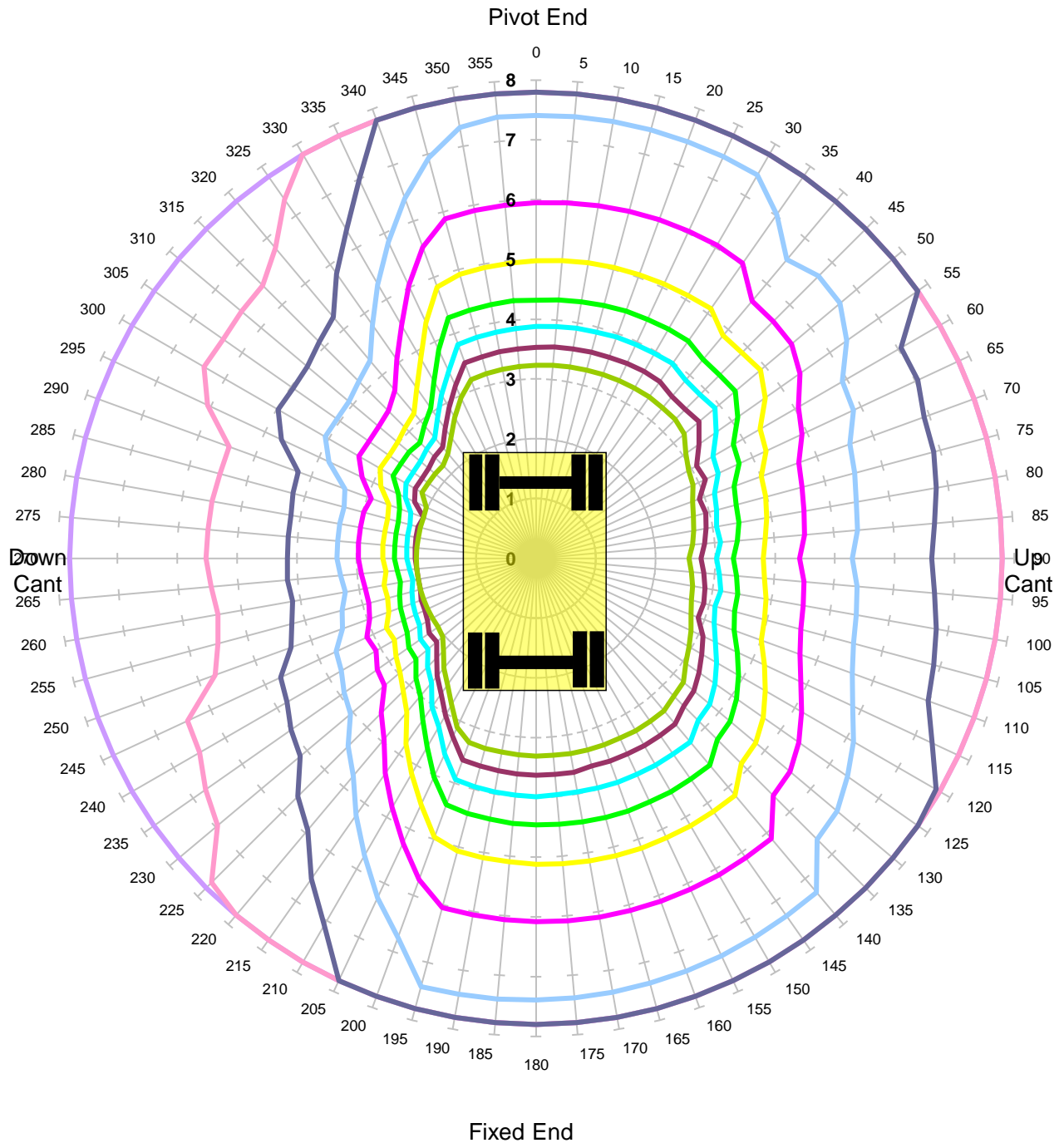

Units in Tonnes

- 1
- 2
- 3
- 4
- 5
- 6
- 7
- 8
- 9
- 10

<b>MACHINE &amp; MODEL:</b>	Komatsu PW160-11	<b>REFERENCE:</b>	3.00m Jib
<b>SERIAL No:</b>	H65234	<b>DATE OF CHART:</b>	12-Oct-2020
<b>EQUIPMENT:</b>	2.00m + 3.47m + 2.50m	<b>SAFETY FACTOR:</b>	90.0%
<b>COMMENT:</b>			



**Komatsu PW160-11**  
**Max Capacity Contours of Radius(m) Plots 2.5m Dipper**  
**Level Ground Height 2m Lift BP**  
**Unlocked Road**

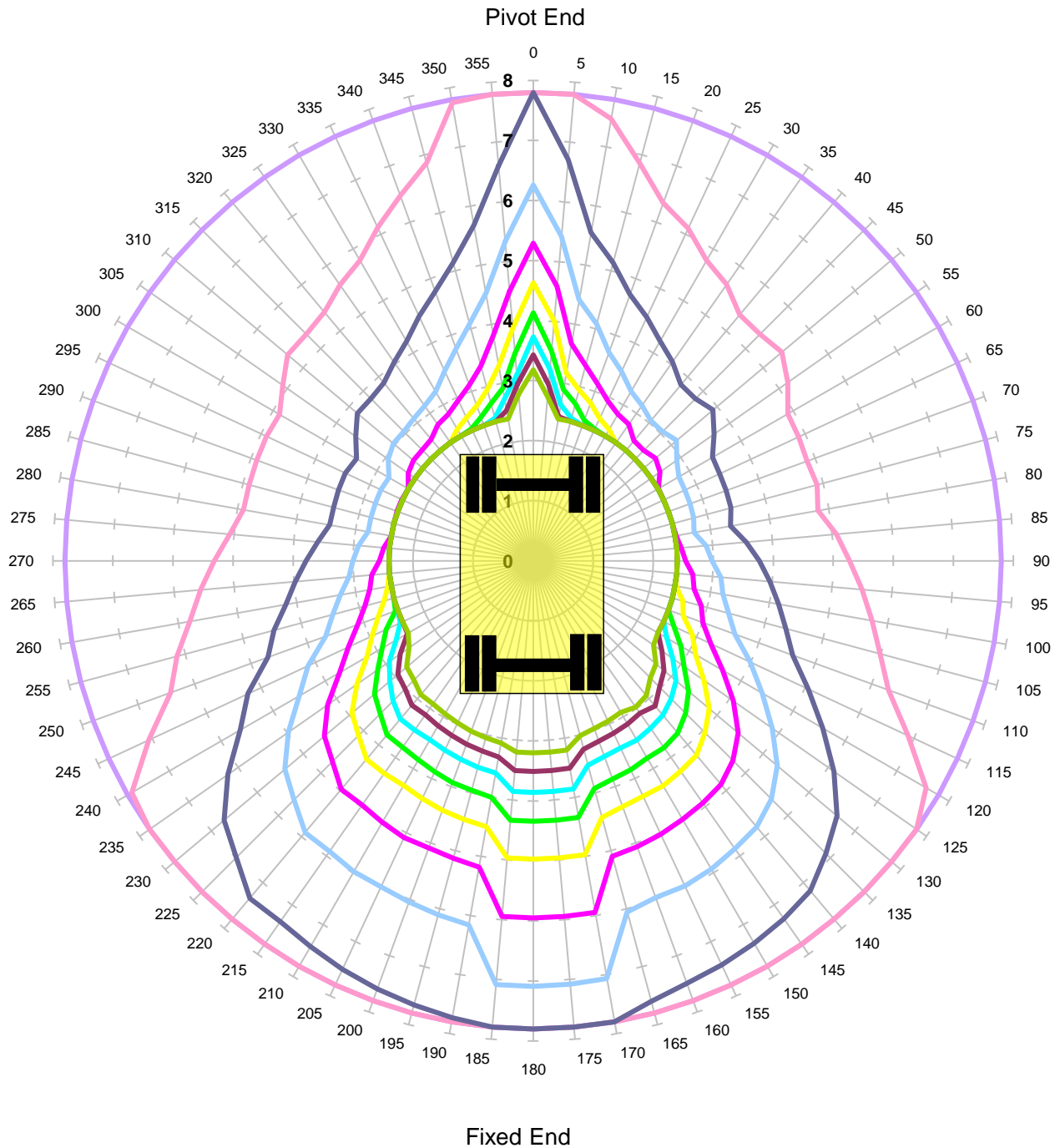

Units in Tonnes

- 1
- 2
- 3
- 4
- 5
- 6
- 7
- 8
- 9
- 10

<b>MACHINE &amp; MODEL:</b>	Komatsu PW160-11	<b>REFERENCE:</b>	3.00m Jib
<b>SERIAL No:</b>	H65234	<b>DATE OF CHART:</b>	12-Oct-2020
<b>EQUIPMENT:</b>	2.00m + 3.47m + 2.50m	<b>SAFETY FACTOR:</b>	71.0%
<b>COMMENT:</b>			

**Komatsu PW160-11**  
**Max Capacity Contours of Radius(m) Plots 2.5m Dipper**  
**Level Ground Height 2m Lift BP**  
**Locked Road**

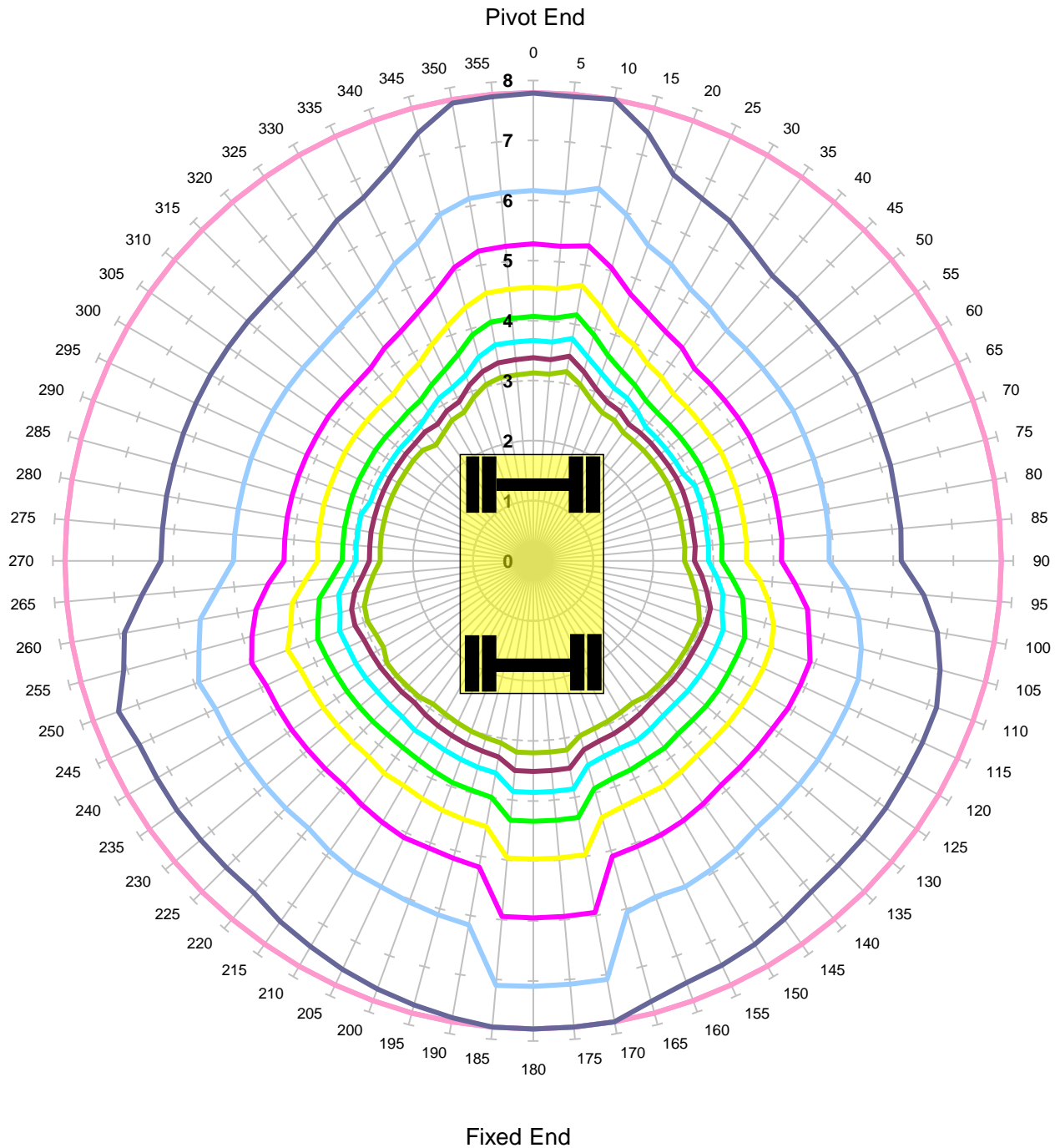

Units in Tonnes

- 1
- 2
- 3
- 4
- 5
- 6
- 7
- 8
- 9
- 10

<b>MACHINE &amp; MODEL:</b>	Komatsu PW160-11	<b>REFERENCE:</b>	3.00m Jib
<b>SERIAL No:</b>	H65234	<b>DATE OF CHART:</b>	12-Oct-2020
<b>EQUIPMENT:</b>	2.00m + 3.47m + 2.50m	<b>SAFETY FACTOR:</b>	71.0%
<b>COMMENT:</b>			

**Komatsu PW160-11**  
**Max Capacity Contours of Radius(m) Plots 2.5m Dipper**  
**Gradient 1 in -25 Height 2m Lift BP**  
**Unlocked Rail Cant -150mm - Tandem Lift**

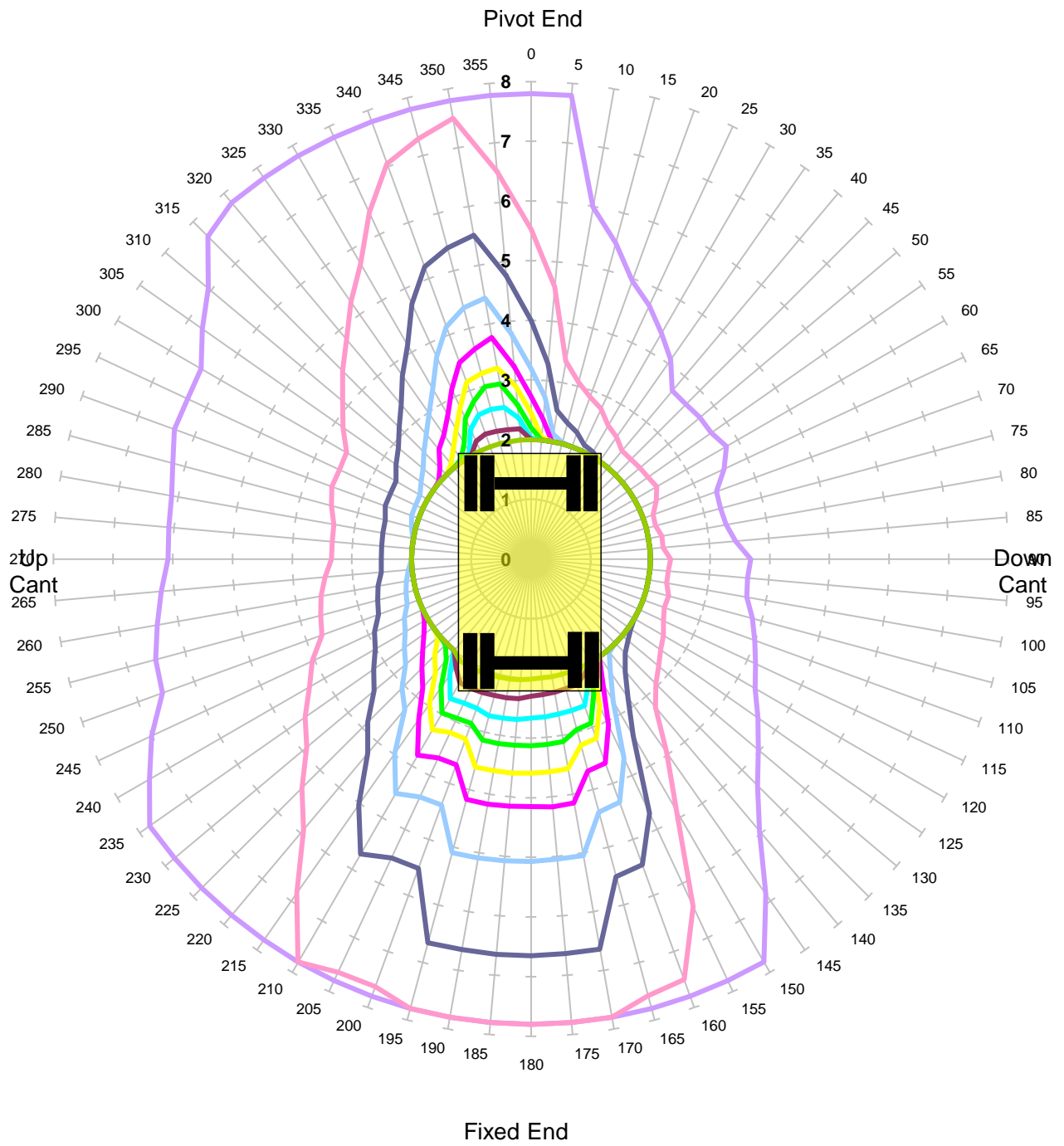

Units in Tonnes

- 1
- 2
- 3
- 4
- 5
- 6
- 7
- 8
- 9
- 10

<b>MACHINE &amp; MODEL:</b>	Komatsu PW160-11	<b>REFERENCE:</b>	3.00m Jib
<b>SERIAL No:</b>	H65234	<b>DATE OF CHART:</b>	12-Oct-2020
<b>EQUIPMENT:</b>	2.00m + 3.47m + 2.50m	<b>SAFETY FACTOR:</b>	44.0%
<b>COMMENT:</b>			

**Komatsu PW160-11**  
**Max Capacity Contours of Radius(m) Plots 2.5m Dipper**  
**Gradient 1 in -25 Height 2m Lift BP**  
**Unlocked Rail Cant -50mm - Tandem Lift**

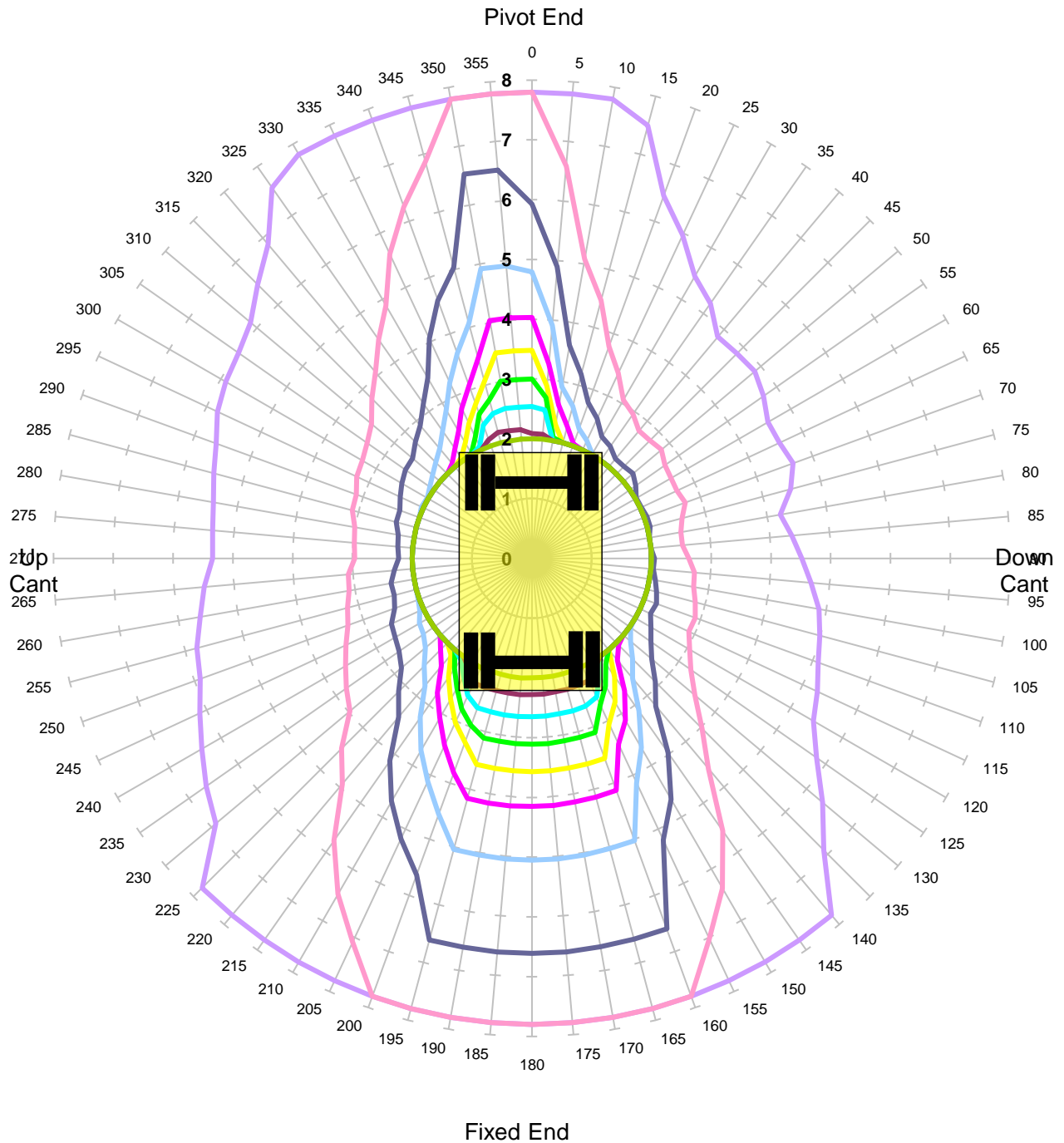

Units in Tonnes

- 1
- 2
- 3
- 4
- 5
- 6
- 7
- 8
- 9
- 10

<b>MACHINE &amp; MODEL:</b>	Komatsu PW160-11	<b>REFERENCE:</b>	3.00m Jib
<b>SERIAL No:</b>	H65234	<b>DATE OF CHART:</b>	12-Oct-2020
<b>EQUIPMENT:</b>	2.00m + 3.47m + 2.50m	<b>SAFETY FACTOR:</b>	44.0%
<b>COMMENT:</b>			

**Komatsu PW160-11**  
**Max Capacity Contours of Radius(m) Plots 2.5m Dipper**  
**Gradient 1 in -25 Height 2m Lift BP**  
**Unlocked Rail Cant 50mm - Tandem Lift**

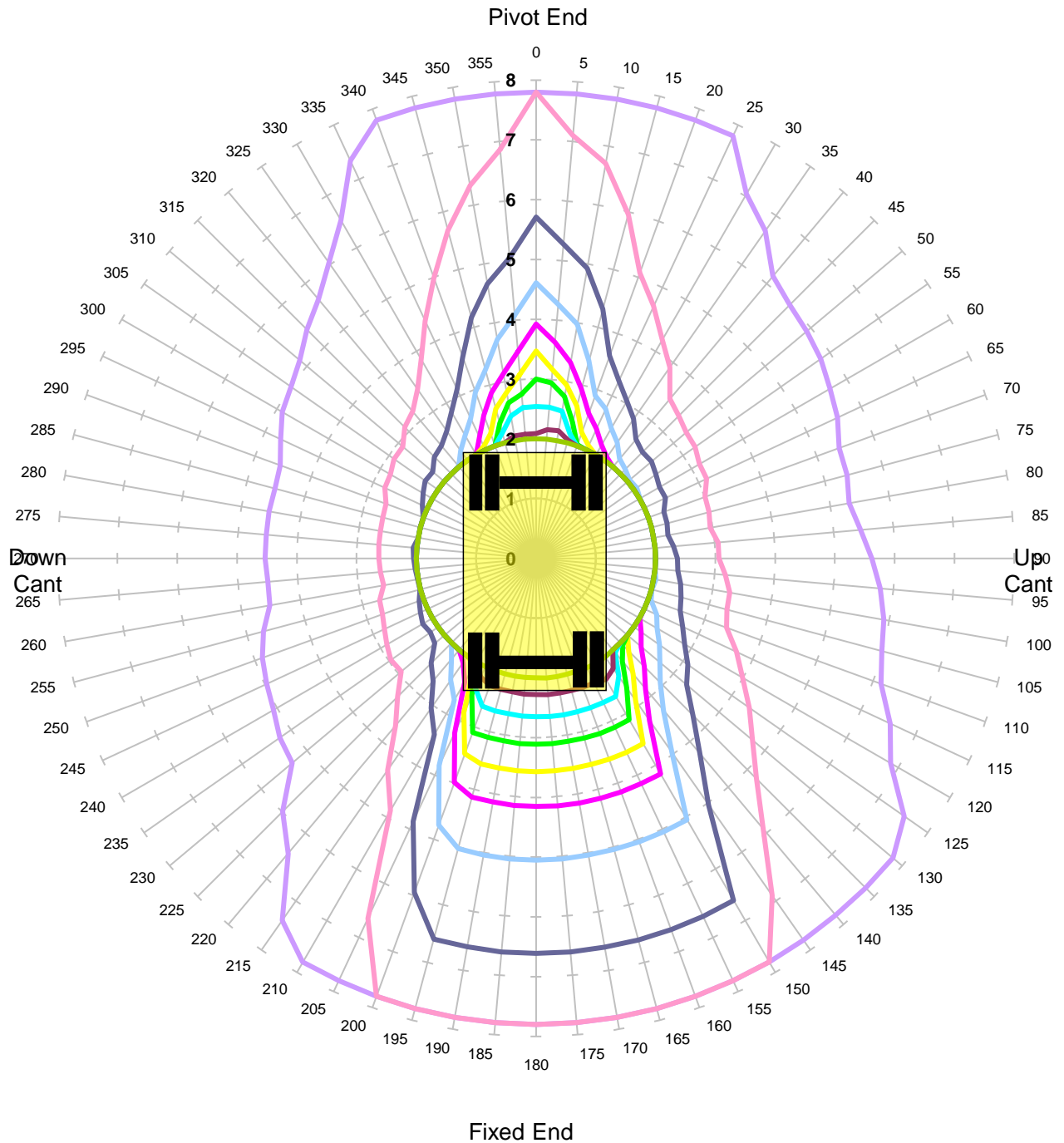

Units in Tonnes

- 1
- 2
- 3
- 4
- 5
- 6
- 7
- 8
- 9
- 10

<b>MACHINE &amp; MODEL:</b>	Komatsu PW160-11	<b>REFERENCE:</b>	3.00m Jib
<b>SERIAL No:</b>	H65234	<b>DATE OF CHART:</b>	12-Oct-2020
<b>EQUIPMENT:</b>	2.00m + 3.47m + 2.50m	<b>SAFETY FACTOR:</b>	44.0%
<b>COMMENT:</b>			

**Komatsu PW160-11**  
**Max Capacity Contours of Radius(m) Plots 2.5m Dipper**  
**Gradient 1 in -25 Height 2m Lift BP**  
**Unlocked Rail Cant 150mm - Tandem Lift**

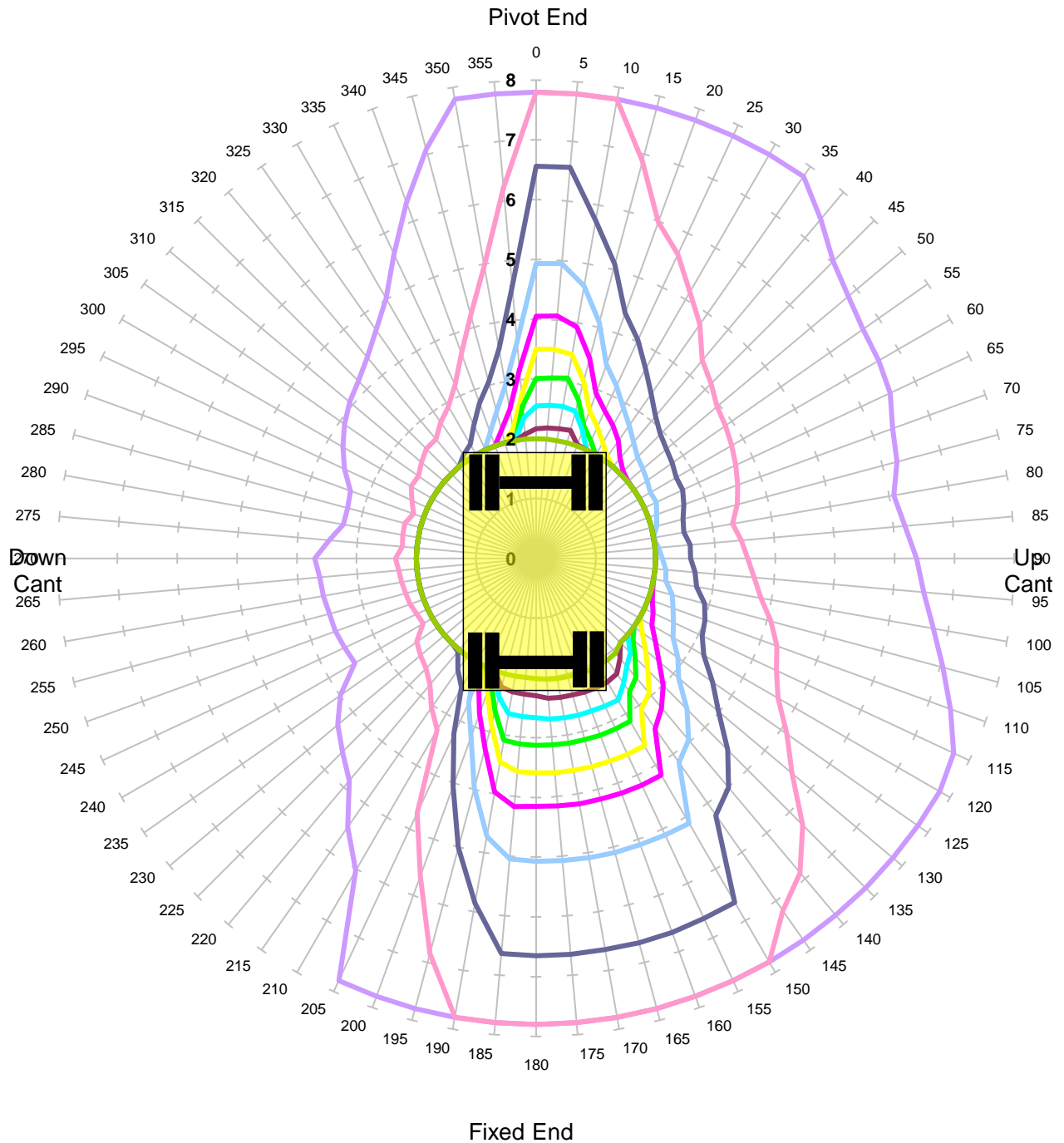

Units in Tonnes

- 1
- 2
- 3
- 4
- 5
- 6
- 7
- 8
- 9
- 10

<b>MACHINE &amp; MODEL:</b>	Komatsu PW160-11	<b>REFERENCE:</b>	3.00m Jib
<b>SERIAL No:</b>	H65234	<b>DATE OF CHART:</b>	12-Oct-2020
<b>EQUIPMENT:</b>	2.00m + 3.47m + 2.50m	<b>SAFETY FACTOR:</b>	44.0%
<b>COMMENT:</b>			



**Komatsu PW160-11**  
**Max Capacity Contours of Radius(m) Plots 2.5m Dipper**  
**Gradient 1 in -25 Height 2m Lift BP**  
**Locked Rail Cant -150mm - Tandem Lift**

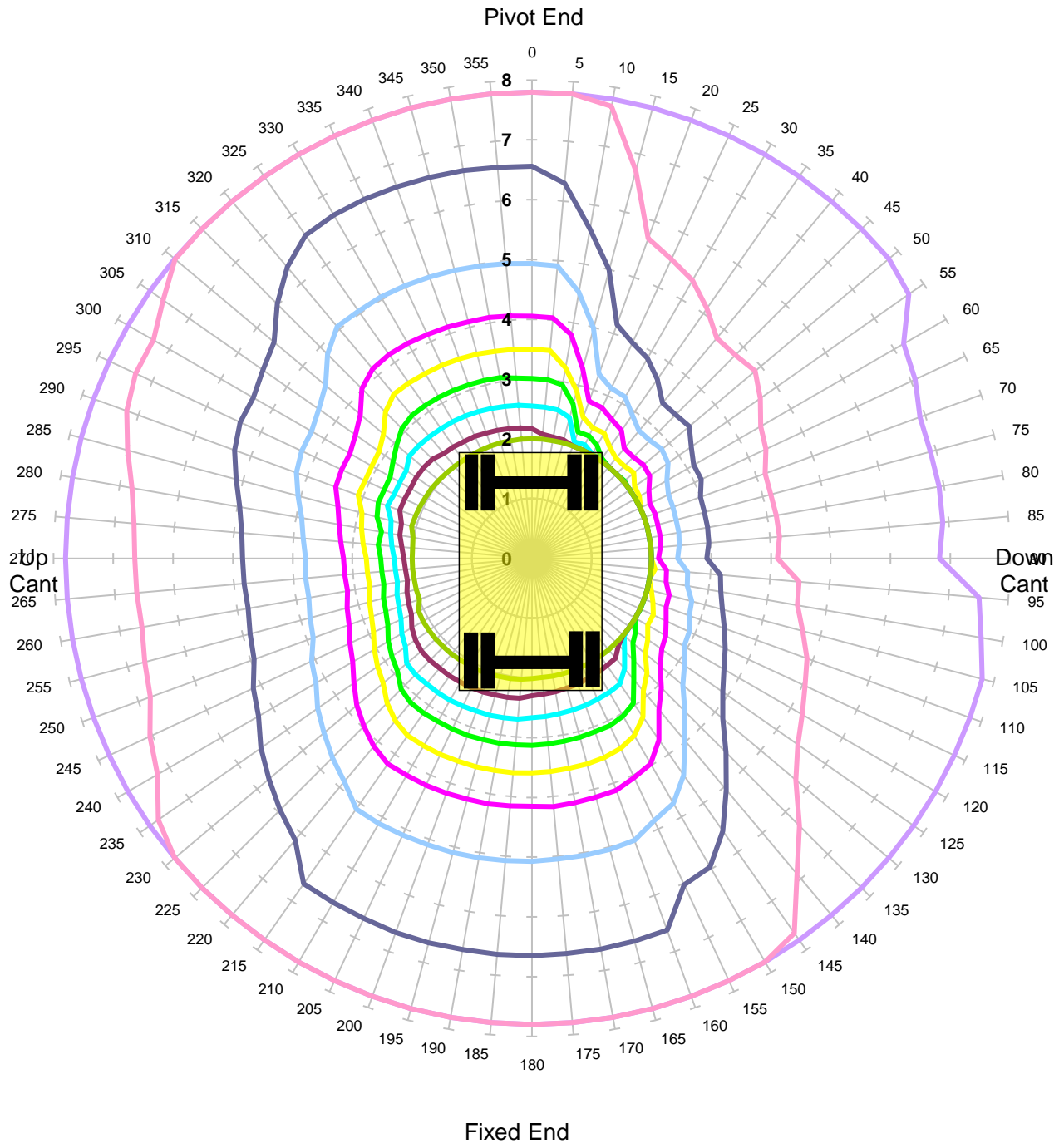

Units in Tonnes

- 1
- 2
- 3
- 4
- 5
- 6
- 7
- 8
- 9
- 10

<b>MACHINE &amp; MODEL:</b>	Komatsu PW160-11	<b>REFERENCE:</b>	3.00m Jib
<b>SERIAL No:</b>	H65234	<b>DATE OF CHART:</b>	12-Oct-2020
<b>EQUIPMENT:</b>	2.00m + 3.47m + 2.50m	<b>SAFETY FACTOR:</b>	59.0%
<b>COMMENT:</b>			

# Komatsu PW160-11

**Max Capacity Contours of Radius(m) Plots 2.5m Dipper  
Gradient 1 in -25 Height 2m Lift BP**

**Locked Rail Cant -50mm - Tandem Lift**

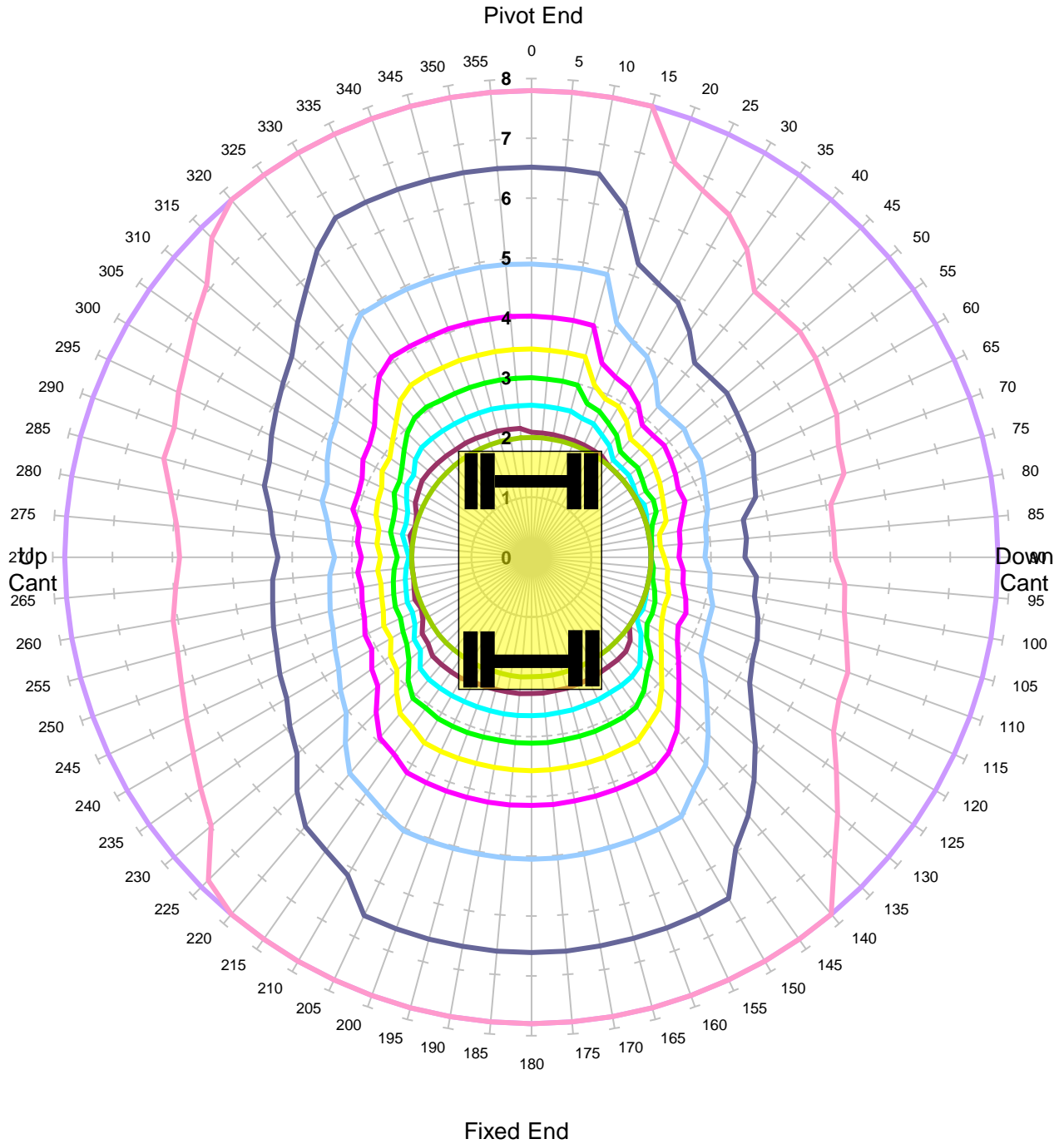

<b>MACHINE &amp; MODEL:</b>	Komatsu PW160-11	<b>REFERENCE:</b>	3.00m Jib
<b>SERIAL No:</b>	H65234	<b>DATE OF CHART:</b>	12-Oct-2020
<b>EQUIPMENT:</b>	2.00m + 3.47m + 2.50m	<b>SAFETY FACTOR:</b>	59.0%
<b>COMMENT:</b>			

**Komatsu PW160-11**  
**Max Capacity Contours of Radius(m) Plots 2.5m Dipper**  
**Gradient 1 in -25 Height 2m Lift BP**  
**Locked Rail Cant 50mm - Tandem Lift**

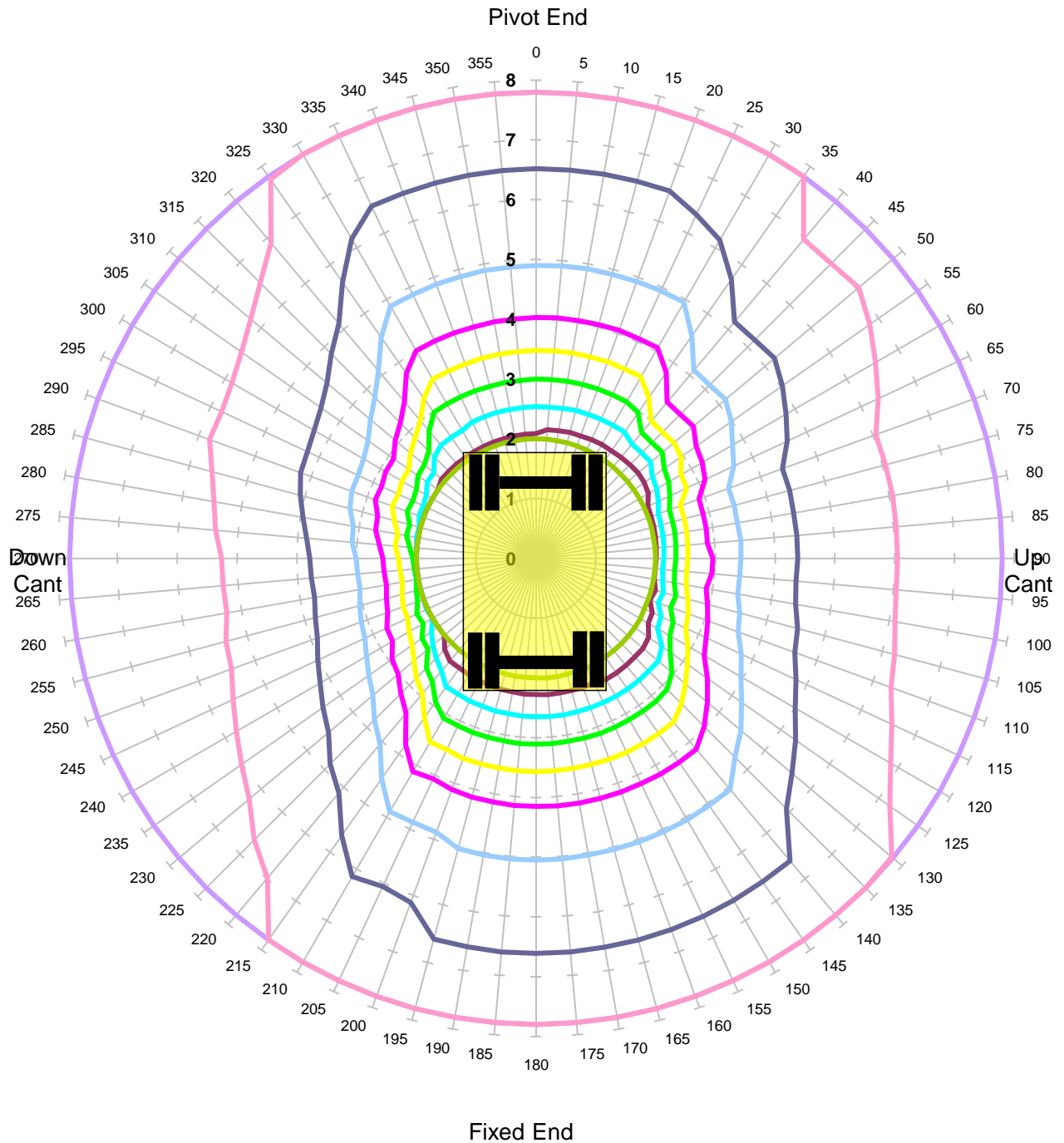

Units in Tonnes

- 1
- 2
- 3
- 4
- 5
- 6
- 7
- 8
- 9
- 10

<b>MACHINE &amp; MODEL:</b>	Komatsu PW160-11	<b>REFERENCE:</b>	3.00m Jib
<b>SERIAL No:</b>	H65234	<b>DATE OF CHART:</b>	12-Oct-2020
<b>EQUIPMENT:</b>	2.00m + 3.47m + 2.50m	<b>SAFETY FACTOR:</b>	59.0%
<b>COMMENT:</b>			

# Komatsu PW160-11

**Max Capacity Contours of Radius(m) Plots 2.5m Dipper  
Gradient 1 in -25 Height 2m Lift BP**

**Locked Rail Cant 150mm - Tandem Lift**

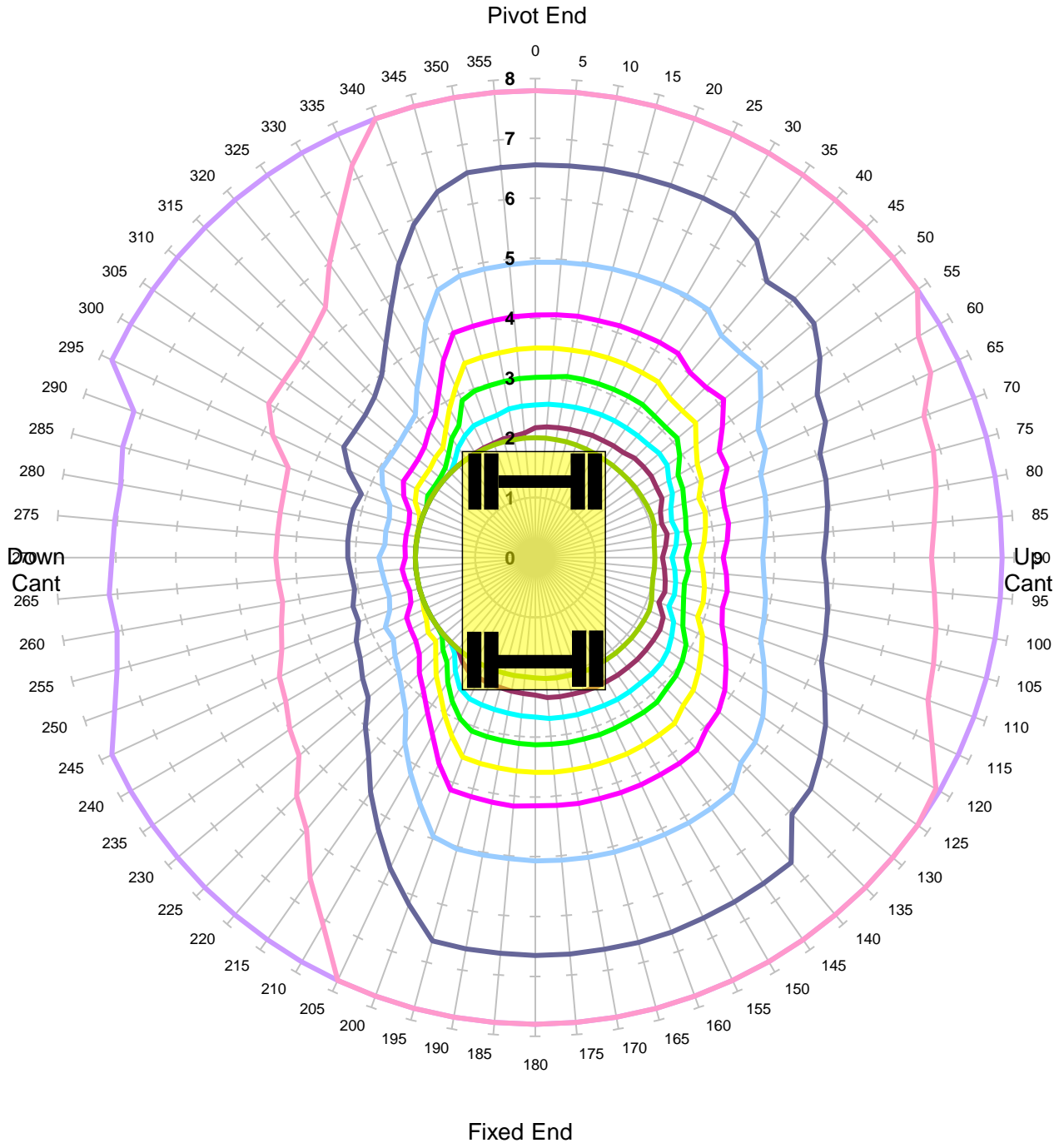

Units in Tonnes

- 1
- 2
- 3
- 4
- 5
- 6
- 7
- 8
- 9
- 10

<b>MACHINE &amp; MODEL:</b>	Komatsu PW160-11	<b>REFERENCE:</b>	3.00m Jib
<b>SERIAL No:</b>	H65234	<b>DATE OF CHART:</b>	12-Oct-2020
<b>EQUIPMENT:</b>	2.00m + 3.47m + 2.50m	<b>SAFETY FACTOR:</b>	59.0%
<b>COMMENT:</b>			

**Komatsu PW160-11**  
**Max Capacity Contours of Radius(m) Plots 2.5m Dipper**  
**Level Ground Height 2m Lift BP**  
**Unlocked Road - Tandem Lift**

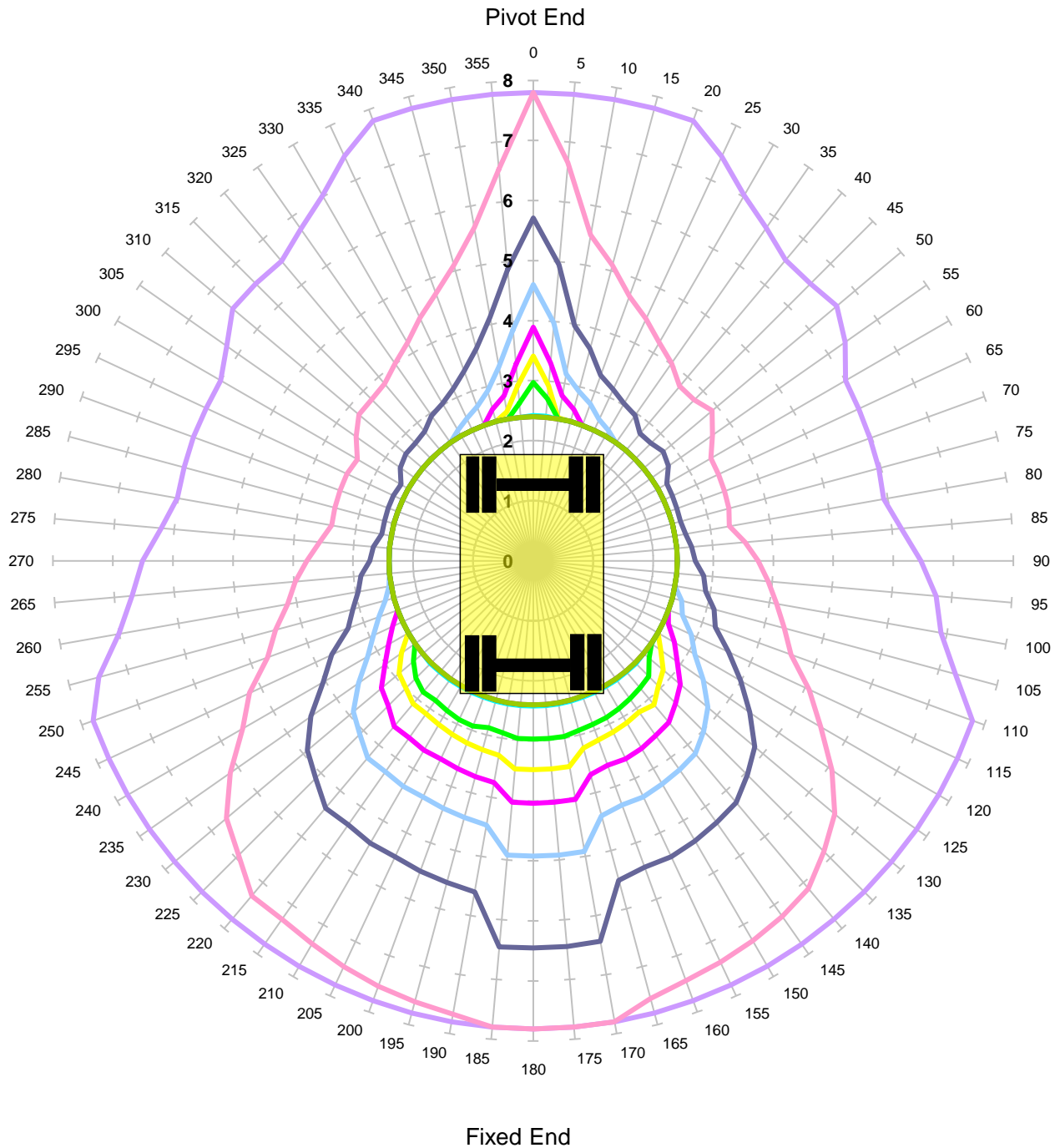

Units in Tonnes

- 1
- 2
- 3
- 4
- 5
- 6
- 7
- 8
- 9
- 10

<b>MACHINE &amp; MODEL:</b>	Komatsu PW160-11	<b>REFERENCE:</b>	3.00m Jib
<b>SERIAL No:</b>	H65234	<b>DATE OF CHART:</b>	12-Oct-2020
<b>EQUIPMENT:</b>	2.00m + 3.47m + 2.50m	<b>SAFETY FACTOR:</b>	47.0%
<b>COMMENT:</b>			

**Komatsu PW160-11**  
**Max Capacity Contours of Radius(m) Plots 2.5m Dipper**  
**Level Ground Height 2m Lift BP**  
**Locked Road - Tandem Lift**

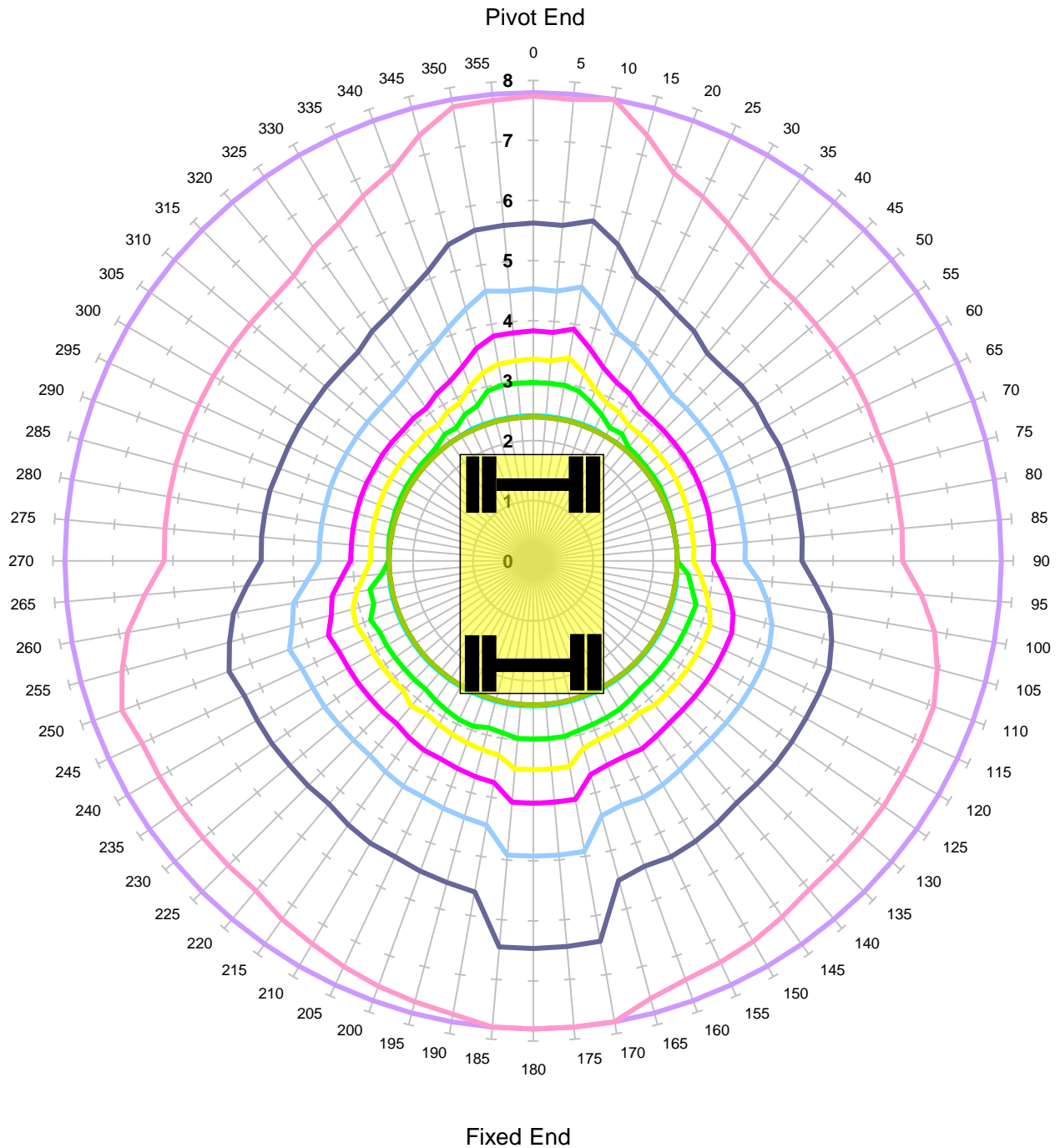

Units in Tonnes

- 1
- 2
- 3
- 4
- 5
- 6
- 7
- 8
- 9
- 10

<b>MACHINE &amp; MODEL:</b>	Komatsu PW160-11	<b>REFERENCE:</b>	3.00m Jib
<b>SERIAL No:</b>	H65234	<b>DATE OF CHART:</b>	12-Oct-2020
<b>EQUIPMENT:</b>	2.00m + 3.47m + 2.50m	<b>SAFETY FACTOR:</b>	47.0%
<b>COMMENT:</b>			



**Komatsu PW160-11**  
**Max Capacity Contours of Radius(m) Plots 2.5m Dipper**  
**Gradient 1 in -25 Height 2m Lift ALP1**  
**Unlocked Rail Cant -150mm**

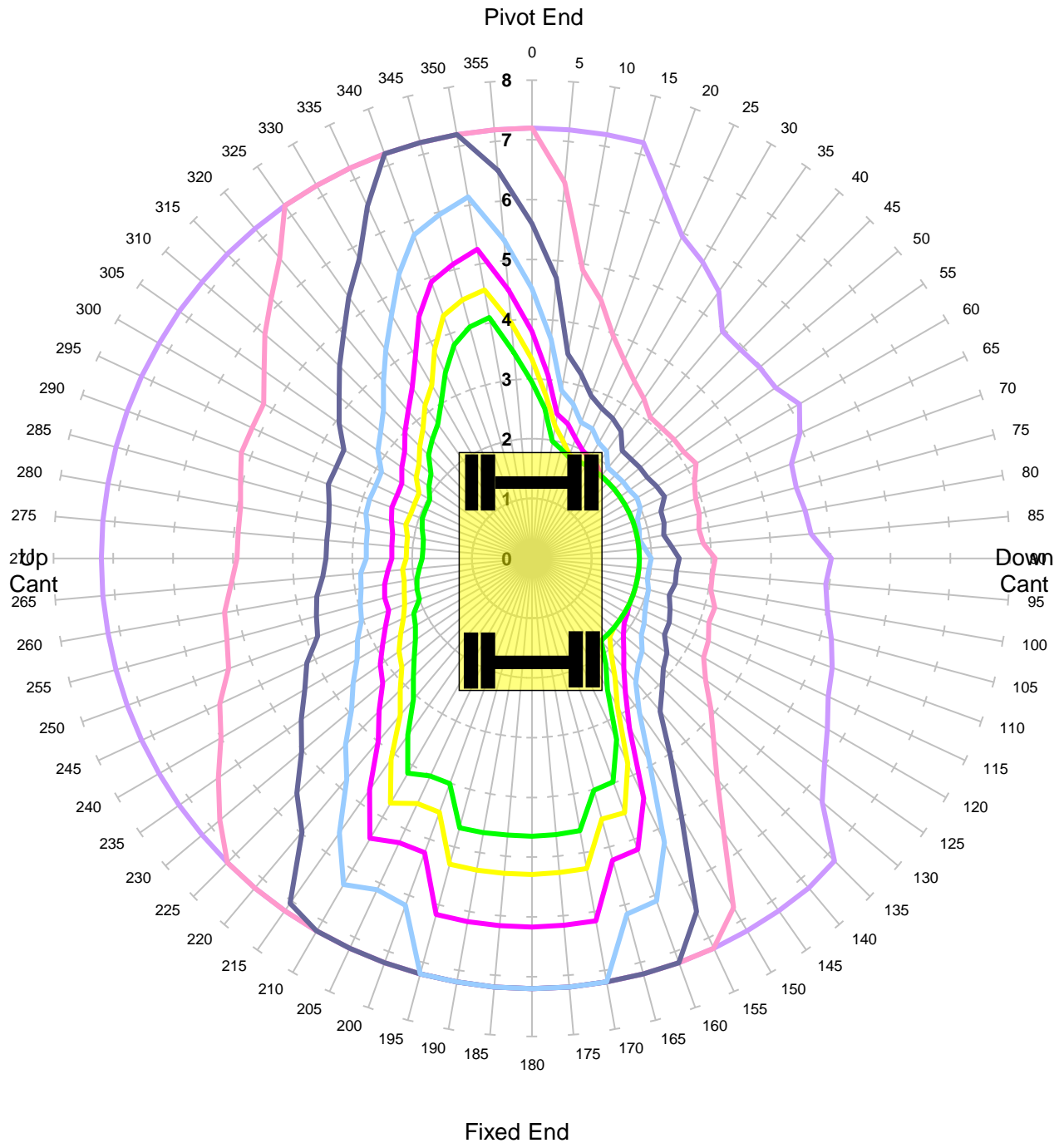

Units in Tonnes

- 1
- 2
- 3
- 4
- 5
- 6
- 7

<b>MACHINE &amp; MODEL:</b>	Komatsu PW160-11	<b>REFERENCE:</b>	3.00m Jib
<b>SERIAL No:</b>	H65234	<b>DATE OF CHART:</b>	12-Oct-2020
<b>EQUIPMENT:</b>	2.00m + 3.47m + 2.50m	<b>SAFETY FACTOR:</b>	67.0%
<b>COMMENT:</b>			

**Komatsu PW160-11**  
**Max Capacity Contours of Radius(m) Plots 2.5m Dipper**  
**Gradient 1 in -25 Height 2m Lift ALP1**  
**Unlocked Rail Cant -50mm**

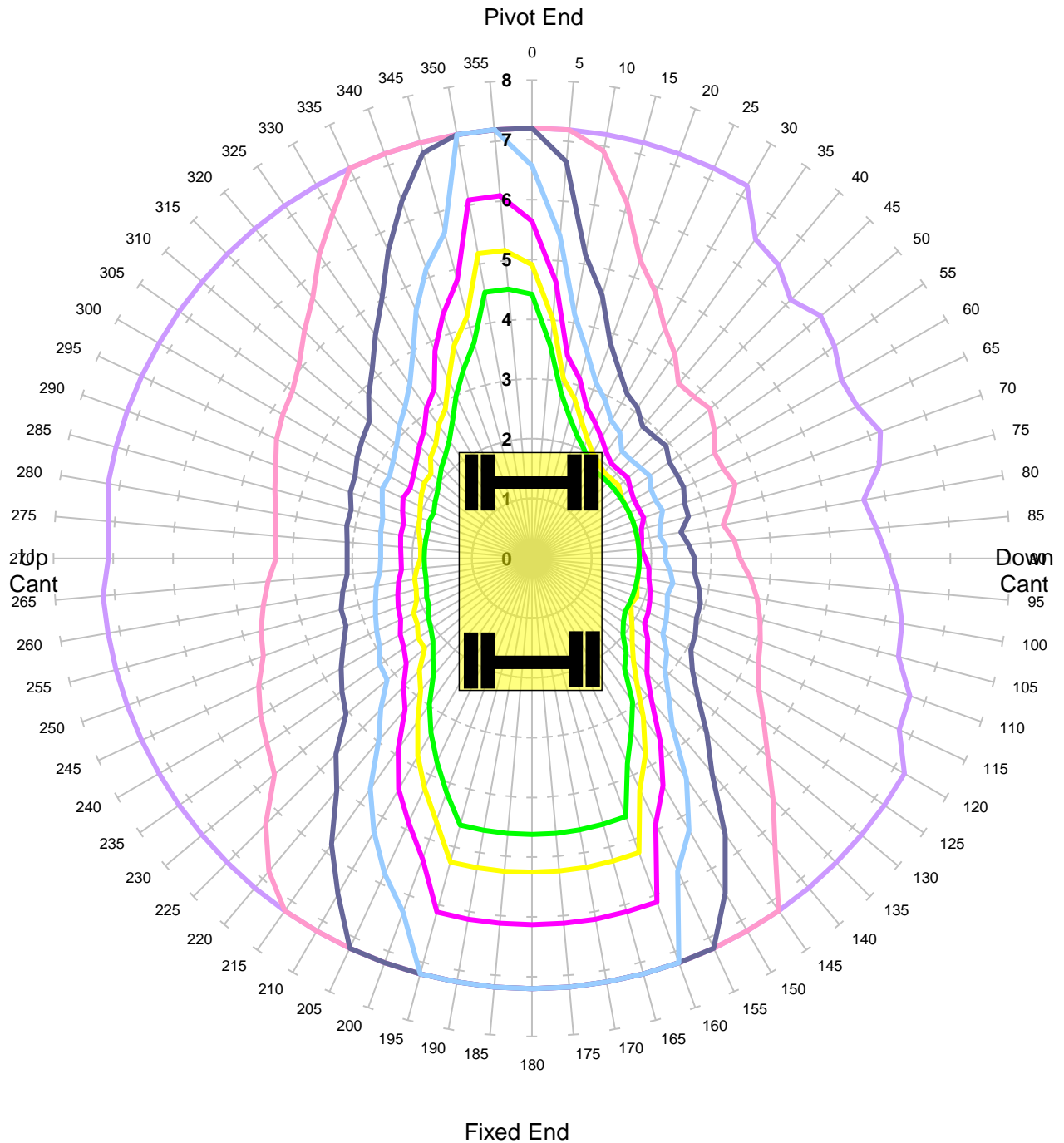

Units in Tonnes

- 1
- 2
- 3
- 4
- 5
- 6
- 7

<b>MACHINE &amp; MODEL:</b>	Komatsu PW160-11	<b>REFERENCE:</b>	3.00m Jib
<b>SERIAL No:</b>	H65234	<b>DATE OF CHART:</b>	12-Oct-2020
<b>EQUIPMENT:</b>	2.00m + 3.47m + 2.50m	<b>SAFETY FACTOR:</b>	67.0%
<b>COMMENT:</b>			

**Komatsu PW160-11**  
**Max Capacity Contours of Radius(m) Plots 2.5m Dipper**  
**Gradient 1 in -25 Height 2m Lift ALP1**  
**Unlocked Rail Cant 50mm**

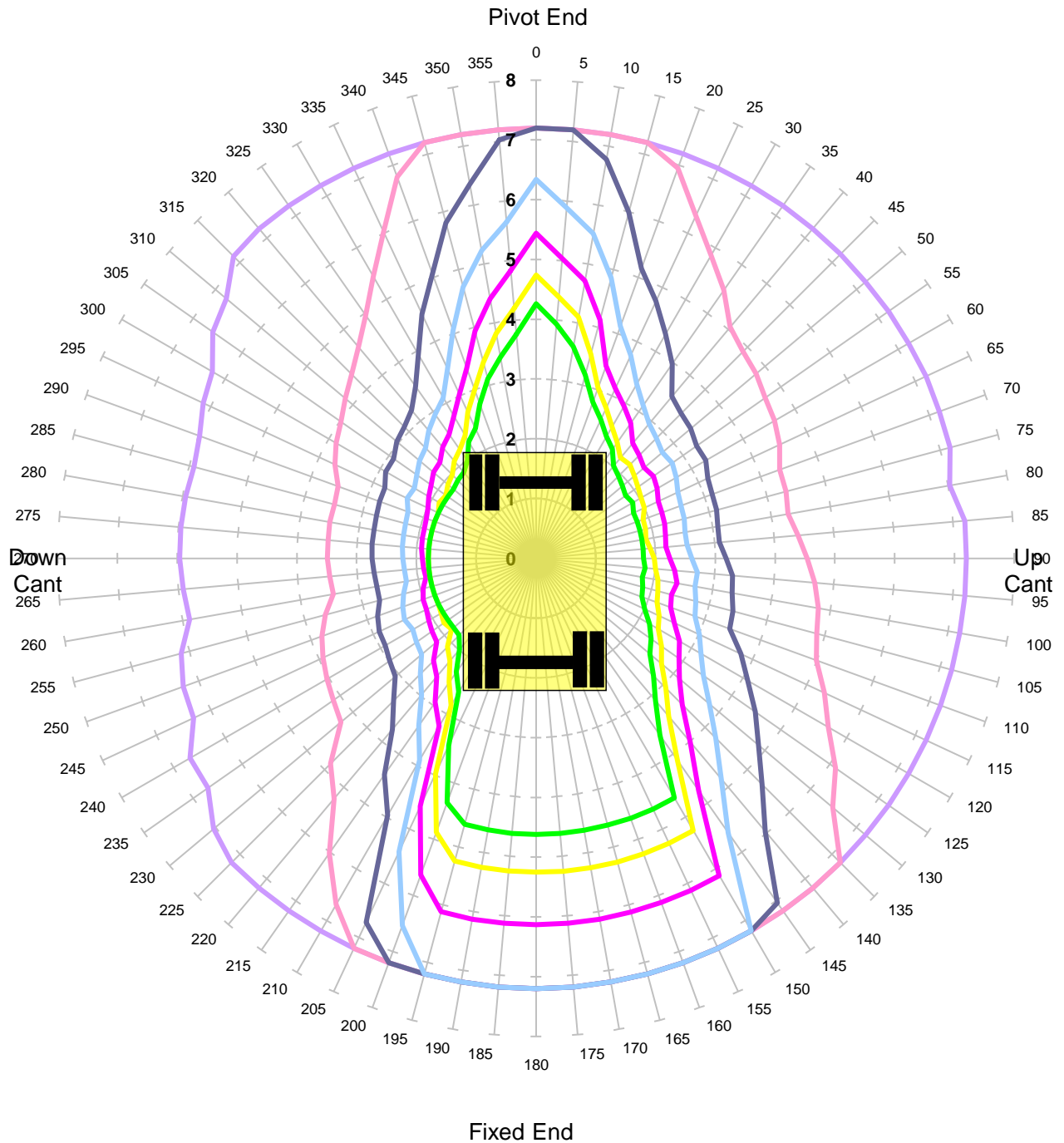

Units in Tonnes

- 1
- 2
- 3
- 4
- 5
- 6
- 7

<b>MACHINE &amp; MODEL:</b>	Komatsu PW160-11	<b>REFERENCE:</b>	3.00m Jib
<b>SERIAL No:</b>	H65234	<b>DATE OF CHART:</b>	12-Oct-2020
<b>EQUIPMENT:</b>	2.00m + 3.47m + 2.50m	<b>SAFETY FACTOR:</b>	67.0%
<b>COMMENT:</b>			

**Komatsu PW160-11**  
**Max Capacity Contours of Radius(m) Plots 2.5m Dipper**  
**Gradient 1 in -25 Height 2m Lift ALP1**  
**Unlocked Rail Cant 150mm**

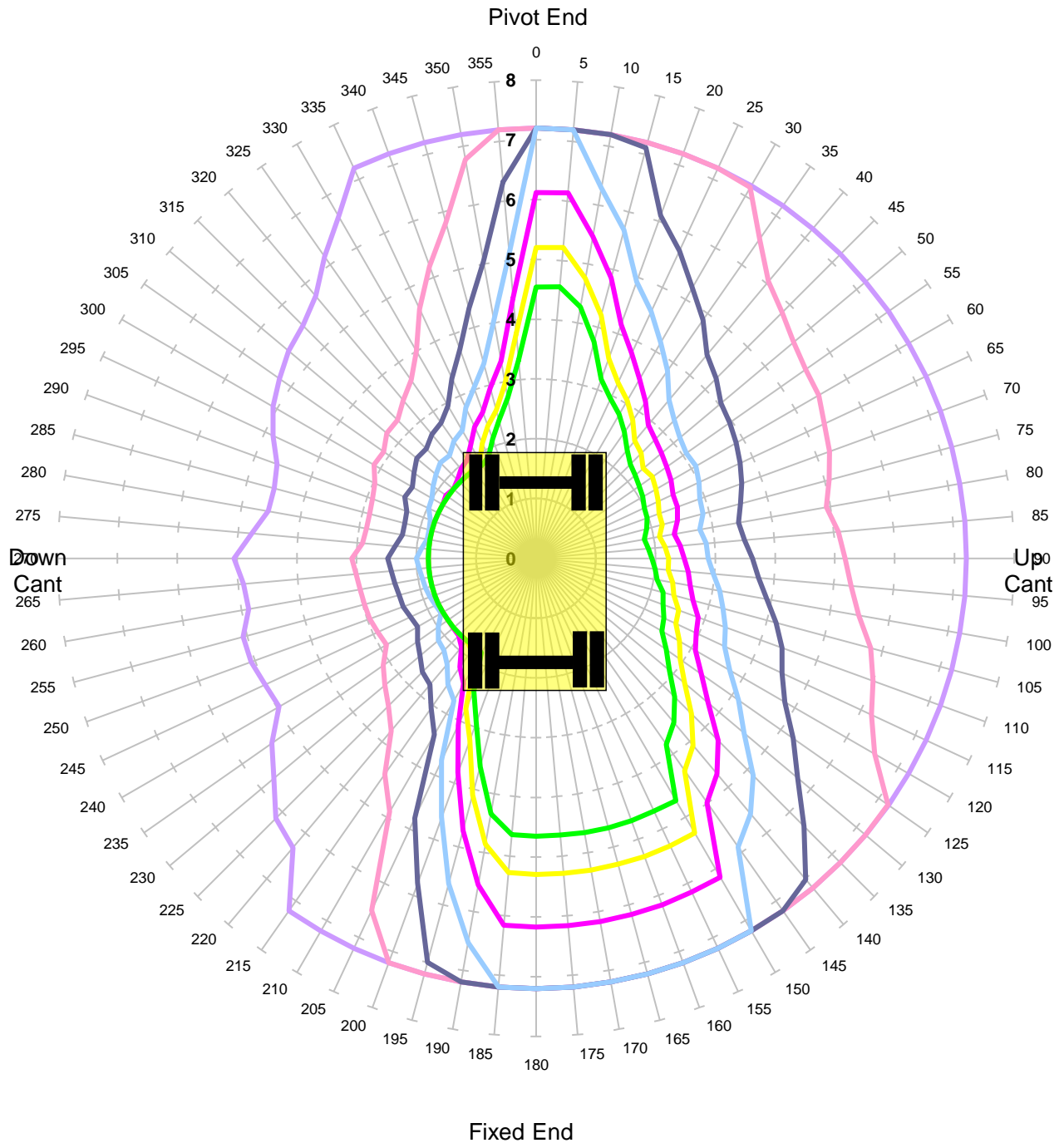

Units in Tonnes

- 1
- 2
- 3
- 4
- 5
- 6
- 7

<b>MACHINE &amp; MODEL:</b>	Komatsu PW160-11	<b>REFERENCE:</b>	3.00m Jib
<b>SERIAL No:</b>	H65234	<b>DATE OF CHART:</b>	12-Oct-2020
<b>EQUIPMENT:</b>	2.00m + 3.47m + 2.50m	<b>SAFETY FACTOR:</b>	67.0%
<b>COMMENT:</b>			

**Komatsu PW160-11**  
**Max Capacity Contours of Radius(m) Plots 2.5m Dipper**  
**Gradient 1 in -25 Height 2m Lift ALP1**  
**Locked Rail Cant -150mm**

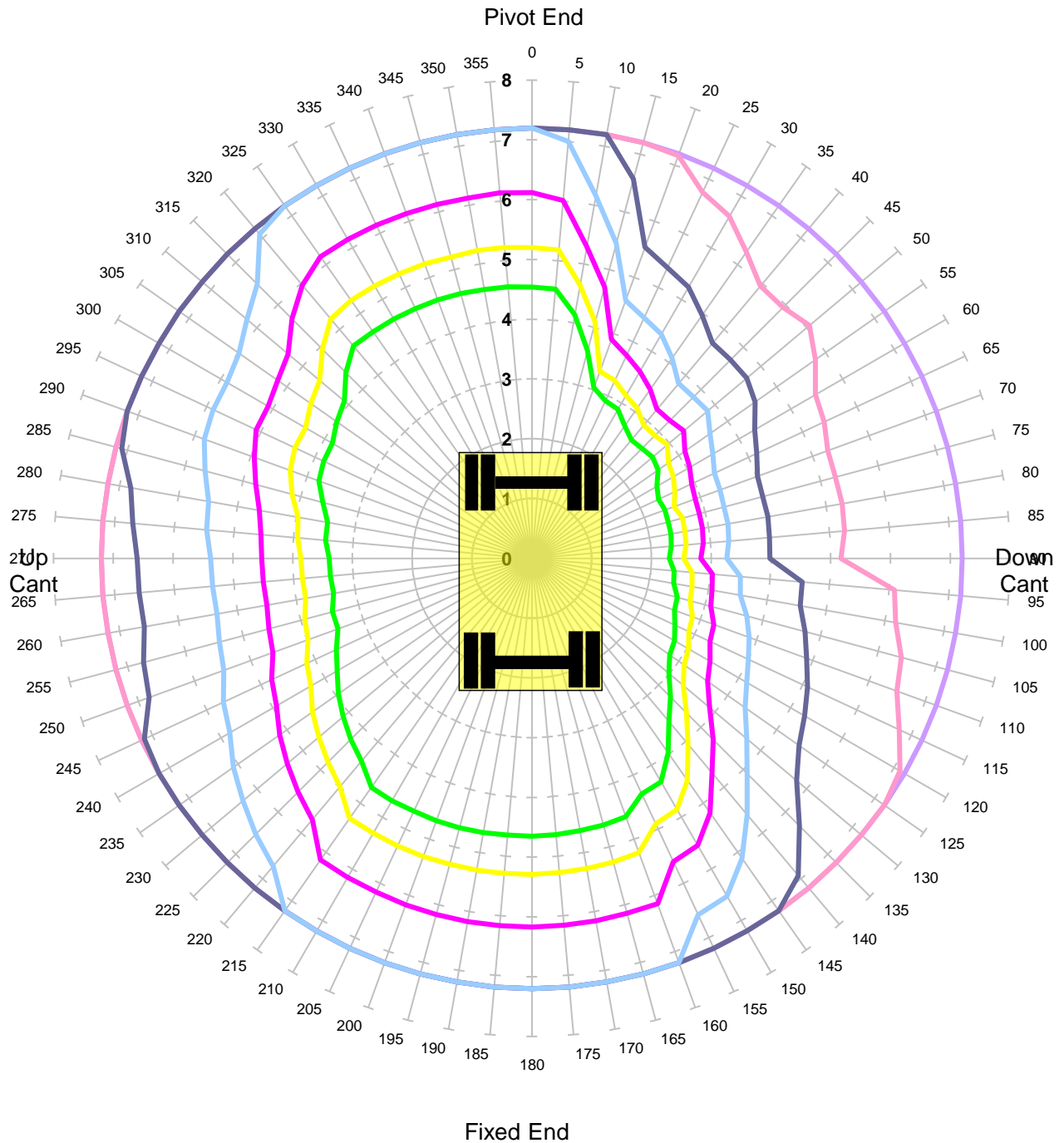

Units in Tonnes

- 1
- 2
- 3
- 4
- 5
- 6
- 7

<b>MACHINE &amp; MODEL:</b>	Komatsu PW160-11	<b>REFERENCE:</b>	3.00m Jib
<b>SERIAL No:</b>	H65234	<b>DATE OF CHART:</b>	12-Oct-2020
<b>EQUIPMENT:</b>	2.00m + 3.47m + 2.50m	<b>SAFETY FACTOR:</b>	90.0%
<b>COMMENT:</b>			

**Komatsu PW160-11**  
**Max Capacity Contours of Radius(m) Plots 2.5m Dipper**  
**Gradient 1 in -25 Height 2m Lift ALP1**  
**Locked Rail Cant -50mm**

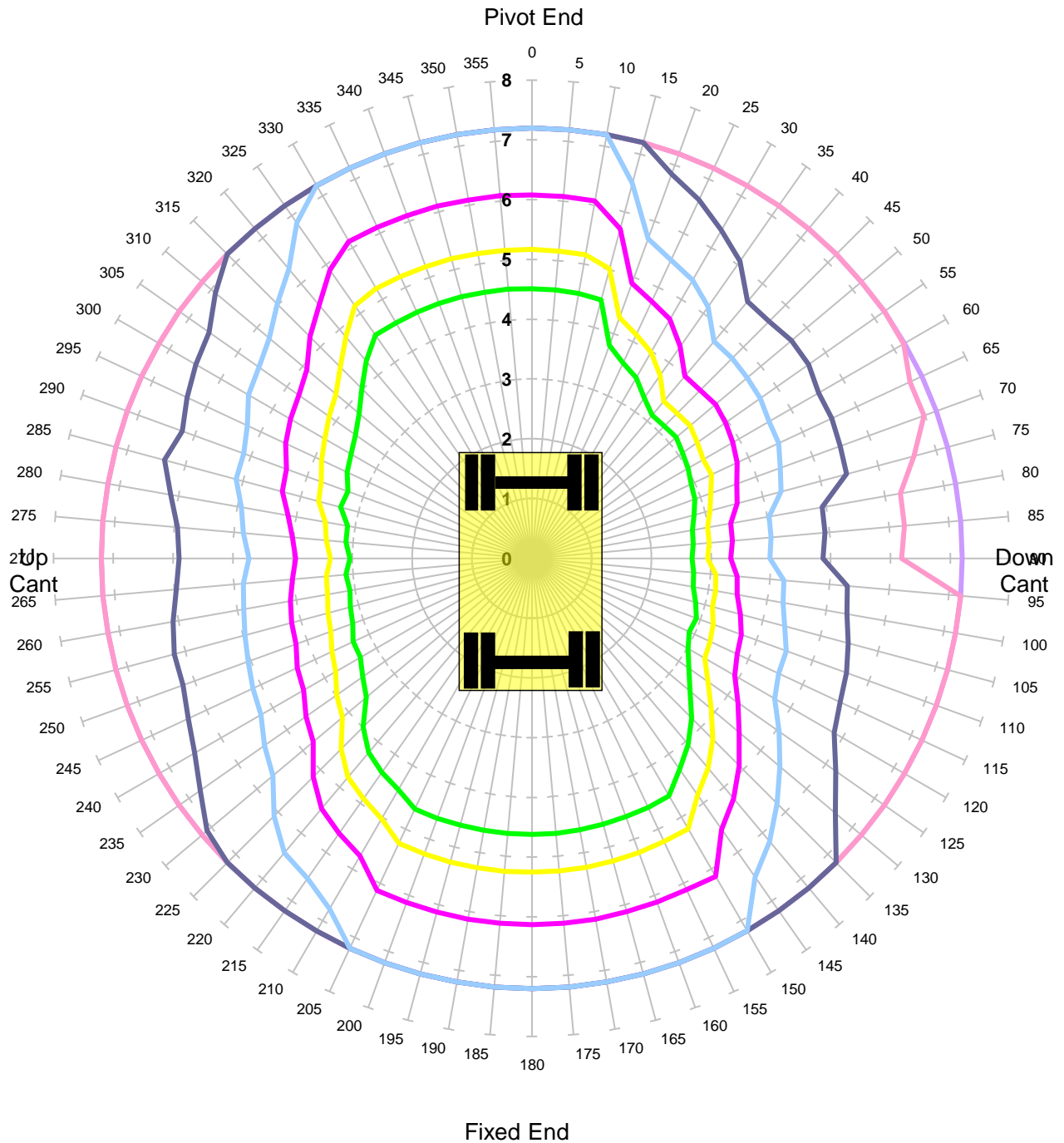

Units in Tonnes

- 1
- 2
- 3
- 4
- 5
- 6
- 7

<b>MACHINE &amp; MODEL:</b>	Komatsu PW160-11	<b>REFERENCE:</b>	3.00m Jib
<b>SERIAL No:</b>	H65234	<b>DATE OF CHART:</b>	12-Oct-2020
<b>EQUIPMENT:</b>	2.00m + 3.47m + 2.50m	<b>SAFETY FACTOR:</b>	90.0%
<b>COMMENT:</b>			



**Komatsu PW160-11**  
**Max Capacity Contours of Radius(m) Plots 2.5m Dipper**  
**Gradient 1 in -25 Height 2m Lift ALP1**  
**Locked Rail Cant 50mm**

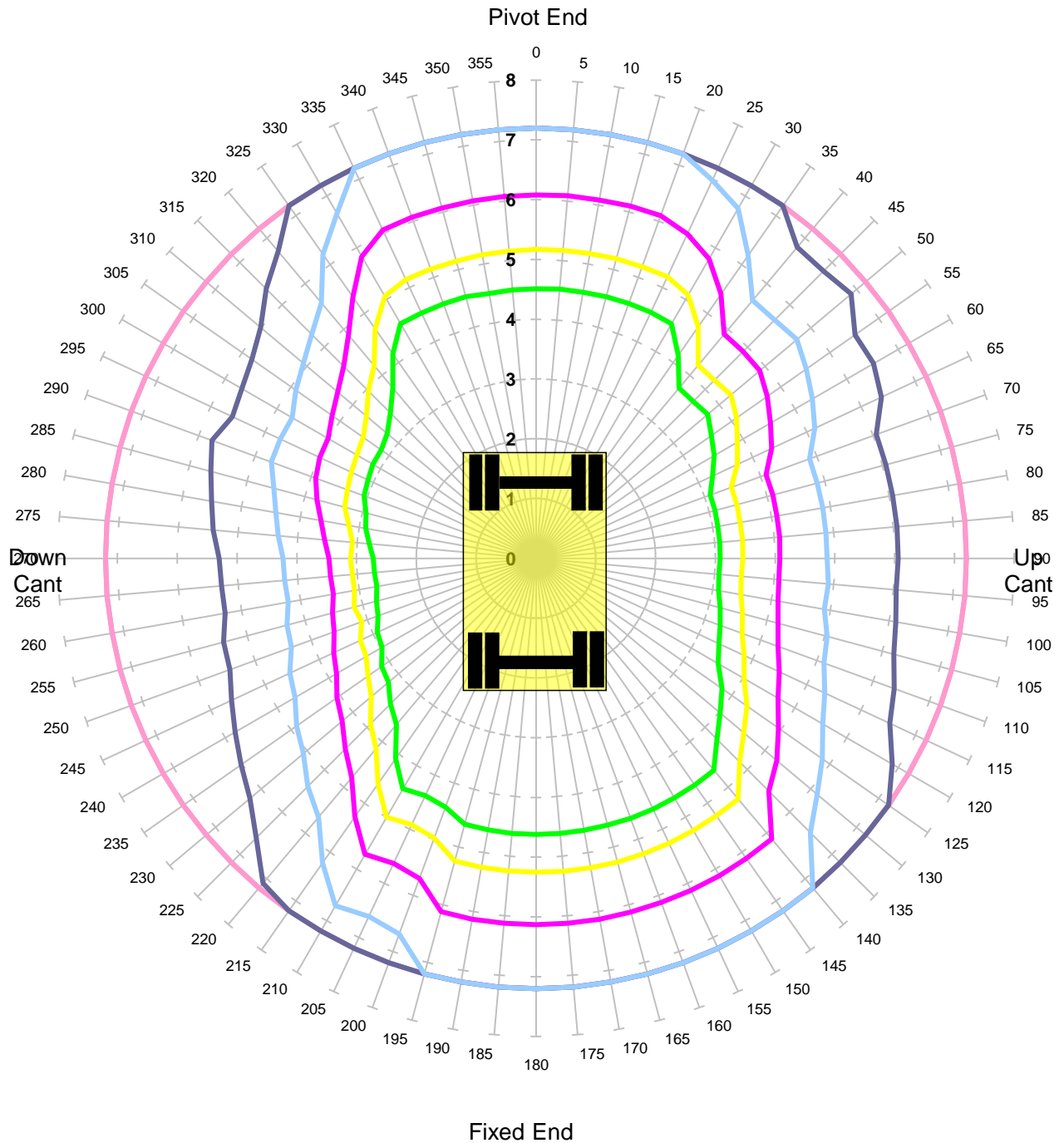

Units in Tonnes

- 1
- 2
- 3
- 4
- 5
- 6
- 7

<b>MACHINE &amp; MODEL:</b>	Komatsu PW160-11	<b>REFERENCE:</b>	3.00m Jib
<b>SERIAL No:</b>	H65234	<b>DATE OF CHART:</b>	12-Oct-2020
<b>EQUIPMENT:</b>	2.00m + 3.47m + 2.50m	<b>SAFETY FACTOR:</b>	90.0%
<b>COMMENT:</b>			

**Komatsu PW160-11**  
**Max Capacity Contours of Radius(m) Plots 2.5m Dipper**  
**Gradient 1 in -25 Height 2m Lift ALP1**  
**Locked Rail Cant 150mm**

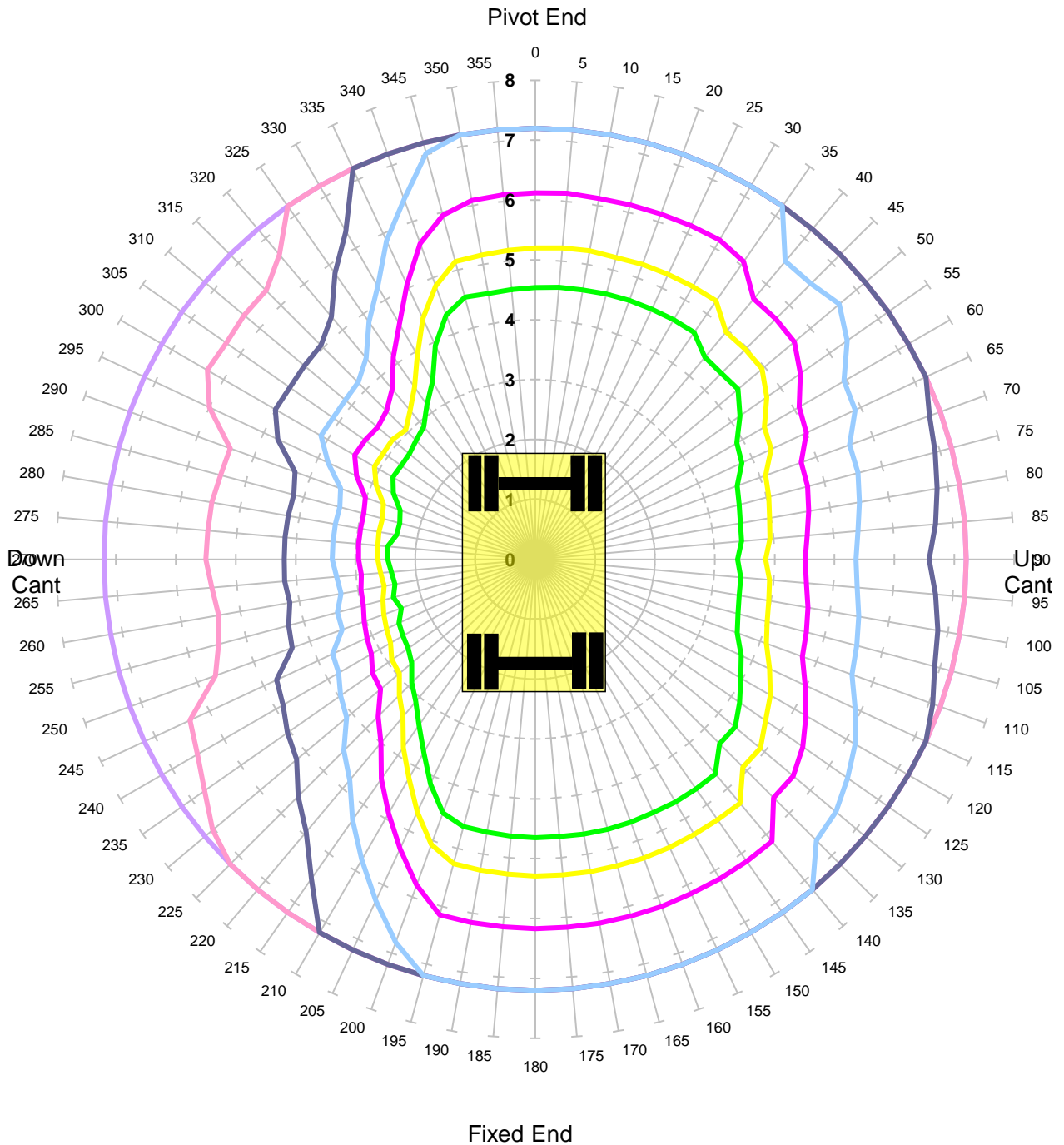

Units in Tonnes

- 1
- 2
- 3
- 4
- 5
- 6
- 7

<b>MACHINE &amp; MODEL:</b>	Komatsu PW160-11	<b>REFERENCE:</b>	3.00m Jib
<b>SERIAL No:</b>	H65234	<b>DATE OF CHART:</b>	12-Oct-2020
<b>EQUIPMENT:</b>	2.00m + 3.47m + 2.50m	<b>SAFETY FACTOR:</b>	90.0%
<b>COMMENT:</b>			

**Komatsu PW160-11**  
**Max Capacity Contours of Radius(m) Plots 2.5m Dipper**  
**Level Ground Height 2m Lift ALP1**  
**Unlocked Road**

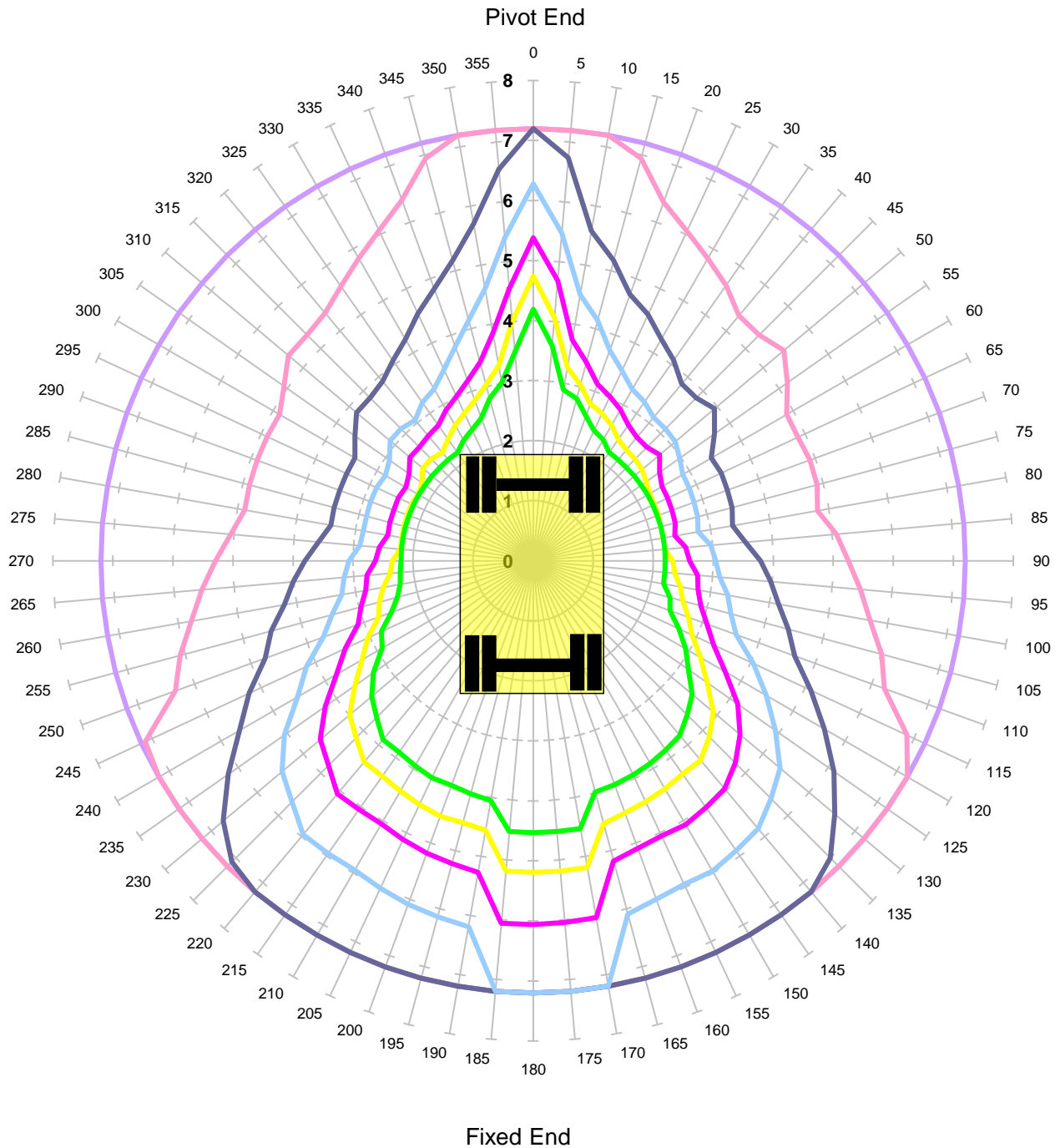

Units in Tonnes

- 1
- 2
- 3
- 4
- 5
- 6
- 7

<b>MACHINE &amp; MODEL:</b>	Komatsu PW160-11	<b>REFERENCE:</b>	3.00m Jib
<b>SERIAL No:</b>	H65234	<b>DATE OF CHART:</b>	12-Oct-2020
<b>EQUIPMENT:</b>	2.00m + 3.47m + 2.50m	<b>SAFETY FACTOR:</b>	71.0%
<b>COMMENT:</b>			

**Komatsu PW160-11**  
**Max Capacity Contours of Radius(m) Plots 2.5m Dipper**  
**Level Ground Height 2m Lift ALP1**  
**Locked Road**

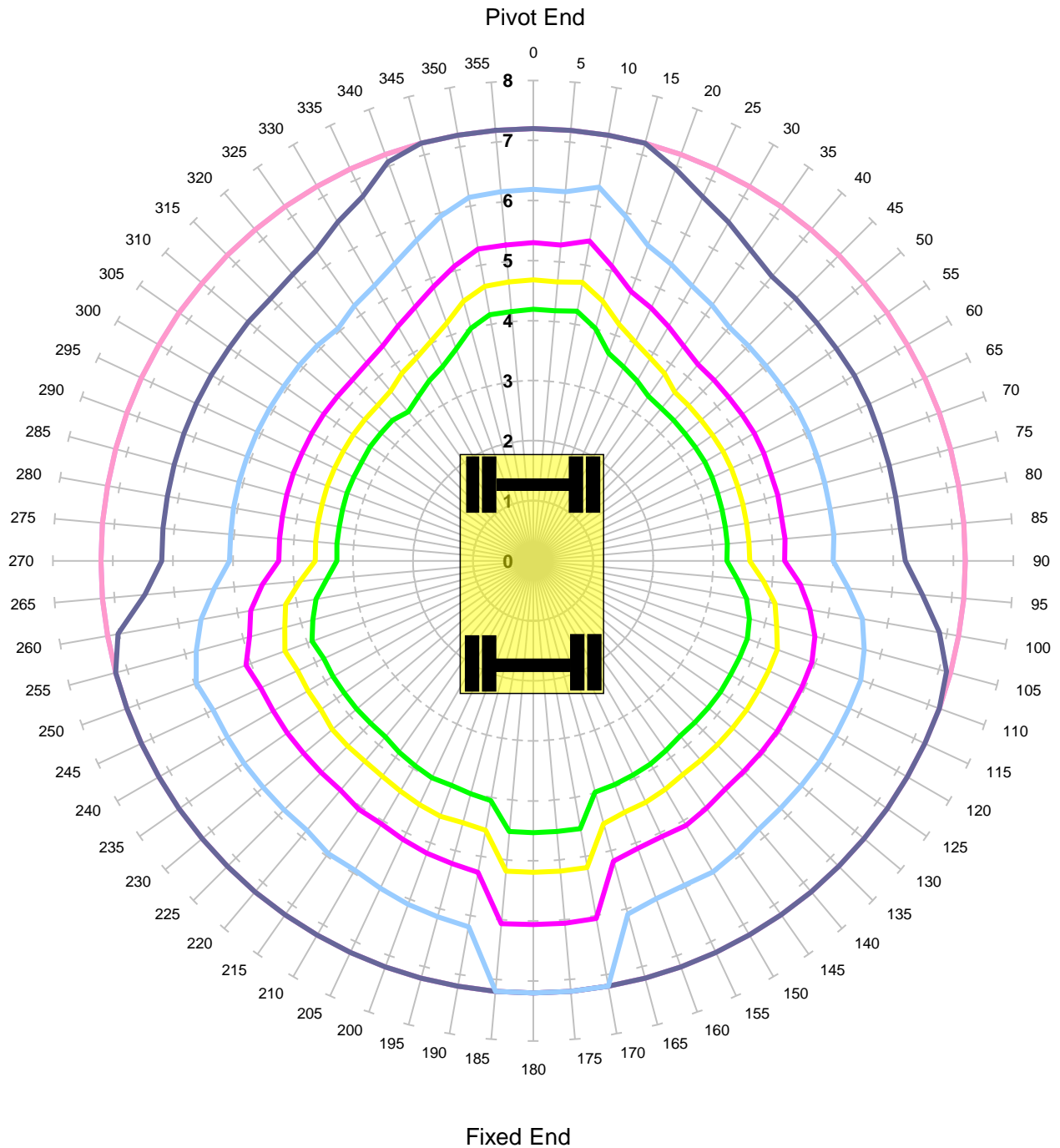

Units in Tonnes

- 1   
 — 2   
 — 3   
 — 4   
 — 5   
 — 6   
 — 7

<b>MACHINE &amp; MODEL:</b>	Komatsu PW160-11	<b>REFERENCE:</b>	3.00m Jib
<b>SERIAL No:</b>	H65234	<b>DATE OF CHART:</b>	12-Oct-2020
<b>EQUIPMENT:</b>	2.00m + 3.47m + 2.50m	<b>SAFETY FACTOR:</b>	71.0%
<b>COMMENT:</b>			

**Komatsu PW160-11**  
**Max Capacity Contours of Radius(m) Plots 2.5m Dipper**  
**Gradient 1 in -25 Height 2m Lift ALP1**  
**Unlocked Rail Cant -150mm - Tandem Lift**

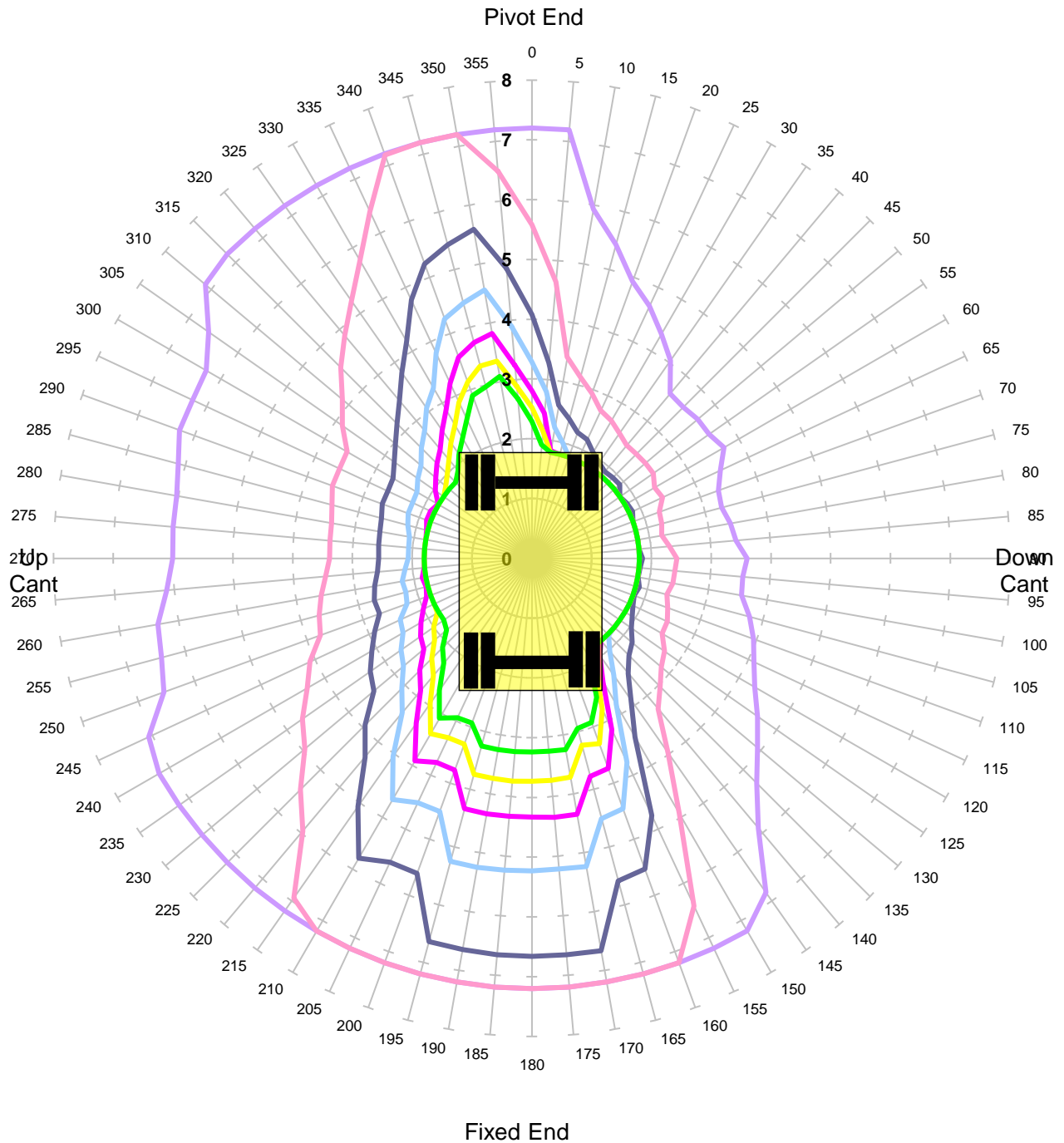

Units in Tonnes

- 1
- 2
- 3
- 4
- 5
- 6
- 7

<b>MACHINE &amp; MODEL:</b>	Komatsu PW160-11	<b>REFERENCE:</b>	3.00m Jib
<b>SERIAL No:</b>	H65234	<b>DATE OF CHART:</b>	12-Oct-2020
<b>EQUIPMENT:</b>	2.00m + 3.47m + 2.50m	<b>SAFETY FACTOR:</b>	44.0%
<b>COMMENT:</b>			

**Komatsu PW160-11**  
**Max Capacity Contours of Radius(m) Plots 2.5m Dipper**  
**Gradient 1 in -25 Height 2m Lift ALP1**  
**Unlocked Rail Cant -50mm - Tandem Lift**

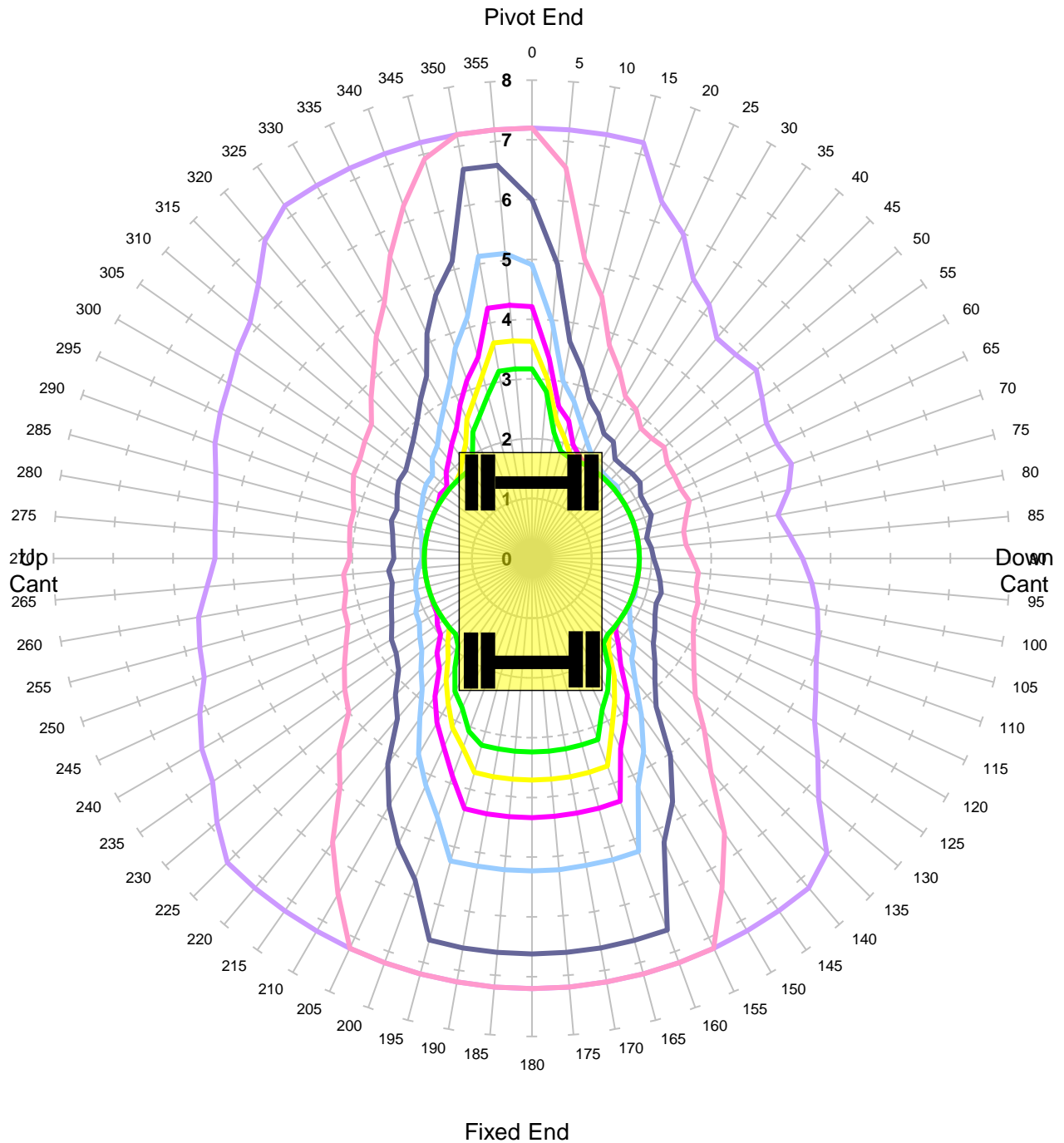

Units in Tonnes

- 1
- 2
- 3
- 4
- 5
- 6
- 7

<b>MACHINE &amp; MODEL:</b>	Komatsu PW160-11	<b>REFERENCE:</b>	3.00m Jib
<b>SERIAL No:</b>	H65234	<b>DATE OF CHART:</b>	12-Oct-2020
<b>EQUIPMENT:</b>	2.00m + 3.47m + 2.50m	<b>SAFETY FACTOR:</b>	44.0%
<b>COMMENT:</b>			



**Komatsu PW160-11**  
**Max Capacity Contours of Radius(m) Plots 2.5m Dipper**  
**Gradient 1 in -25 Height 2m Lift ALP1**  
**Unlocked Rail Cant 50mm - Tandem Lift**

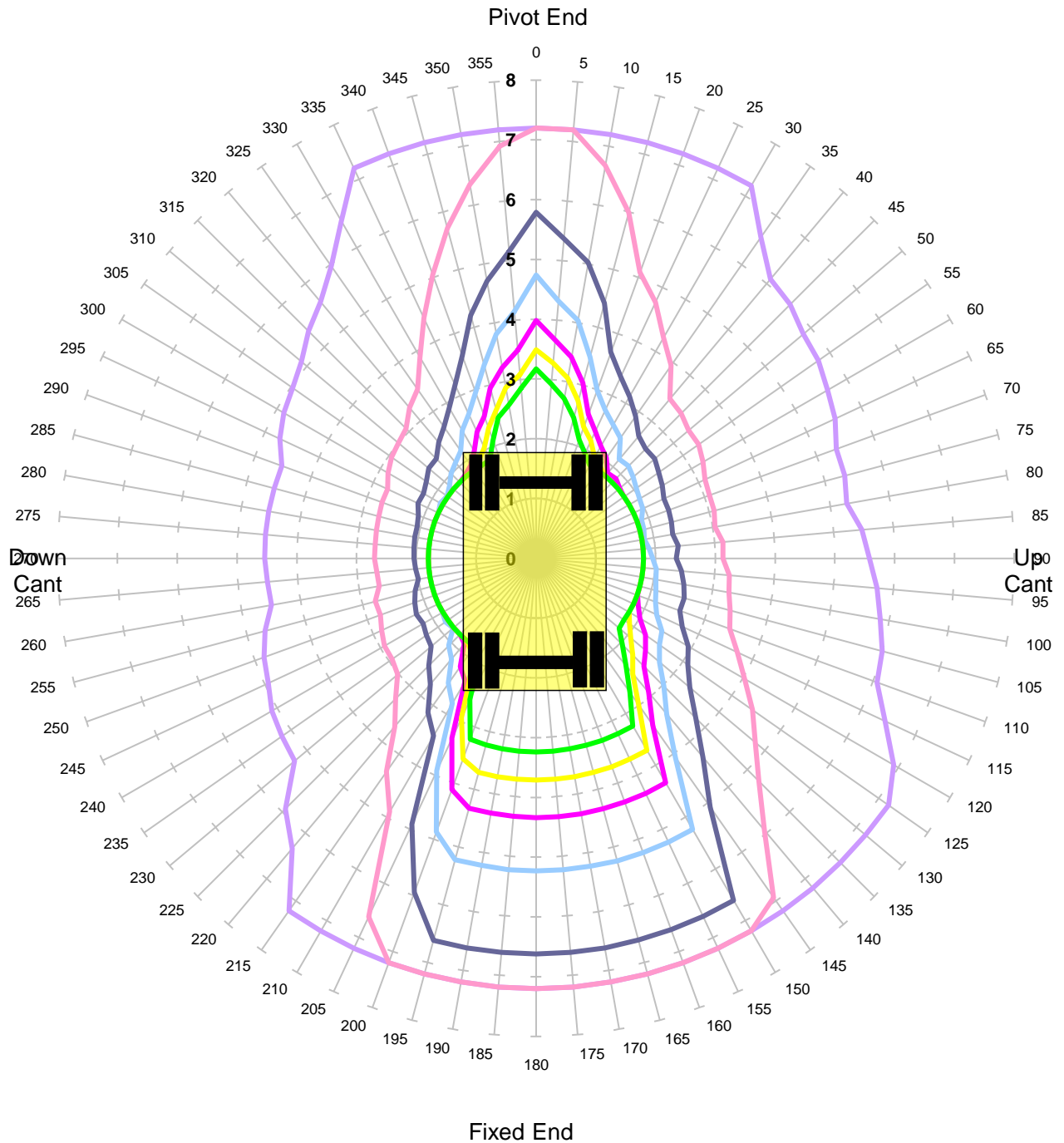

Units in Tonnes

- 1
- 2
- 3
- 4
- 5
- 6
- 7

<b>MACHINE &amp; MODEL:</b>	Komatsu PW160-11	<b>REFERENCE:</b>	3.00m Jib
<b>SERIAL No:</b>	H65234	<b>DATE OF CHART:</b>	12-Oct-2020
<b>EQUIPMENT:</b>	2.00m + 3.47m + 2.50m	<b>SAFETY FACTOR:</b>	44.0%
<b>COMMENT:</b>			

**Komatsu PW160-11**  
**Max Capacity Contours of Radius(m) Plots 2.5m Dipper**  
**Gradient 1 in -25 Height 2m Lift ALP1**  
**Unlocked Rail Cant 150mm - Tandem Lift**

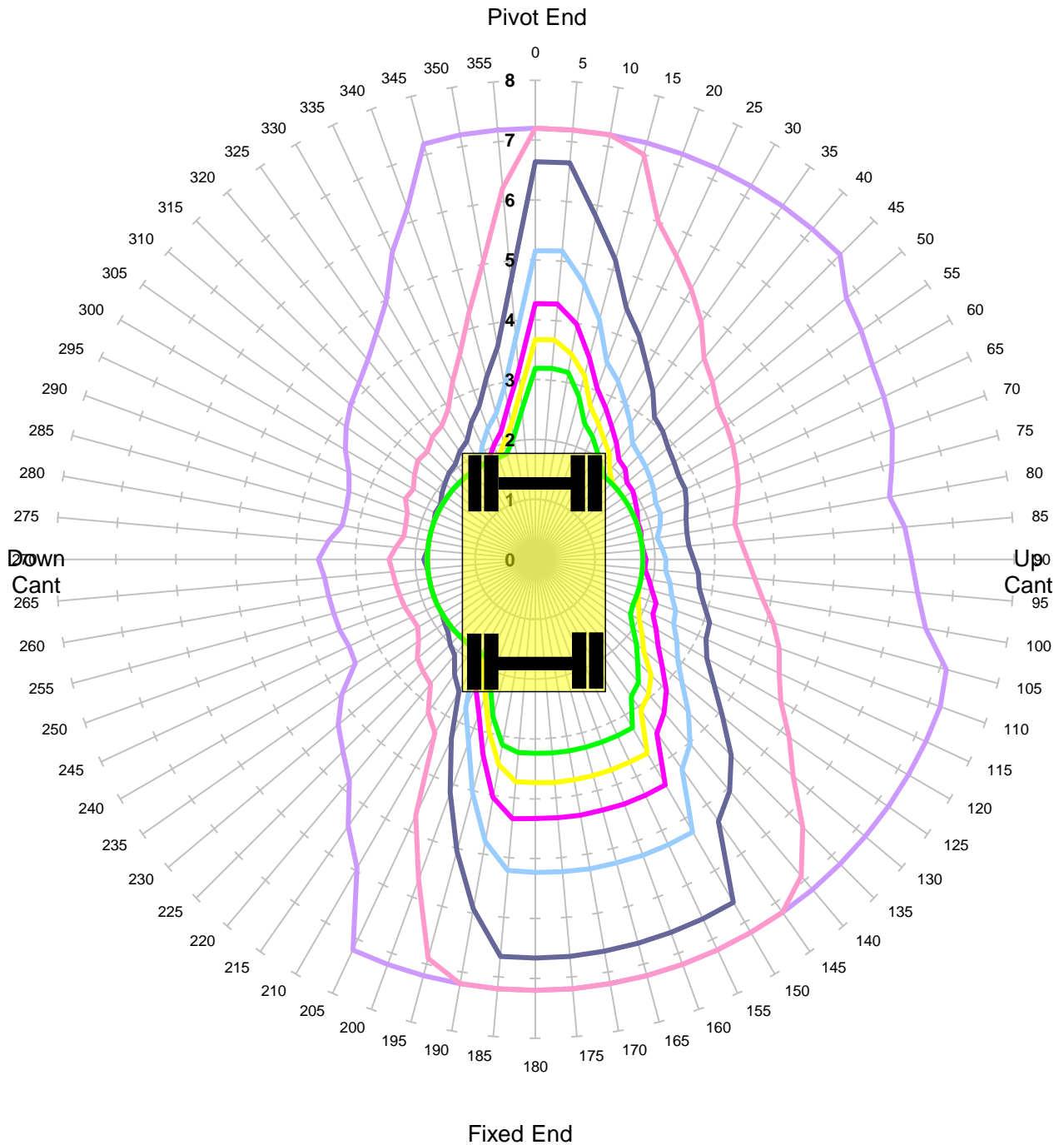

Units in Tonnes

- 1
- 2
- 3
- 4
- 5
- 6
- 7

<b>MACHINE &amp; MODEL:</b>	Komatsu PW160-11	<b>REFERENCE:</b>	3.00m Jib
<b>SERIAL No:</b>	H65234	<b>DATE OF CHART:</b>	12-Oct-2020
<b>EQUIPMENT:</b>	2.00m + 3.47m + 2.50m	<b>SAFETY FACTOR:</b>	44.0%
<b>COMMENT:</b>			

**Komatsu PW160-11**  
**Max Capacity Contours of Radius(m) Plots 2.5m Dipper**  
**Gradient 1 in -25 Height 2m Lift ALP1**  
**Locked Rail Cant -150mm - Tandem Lift**

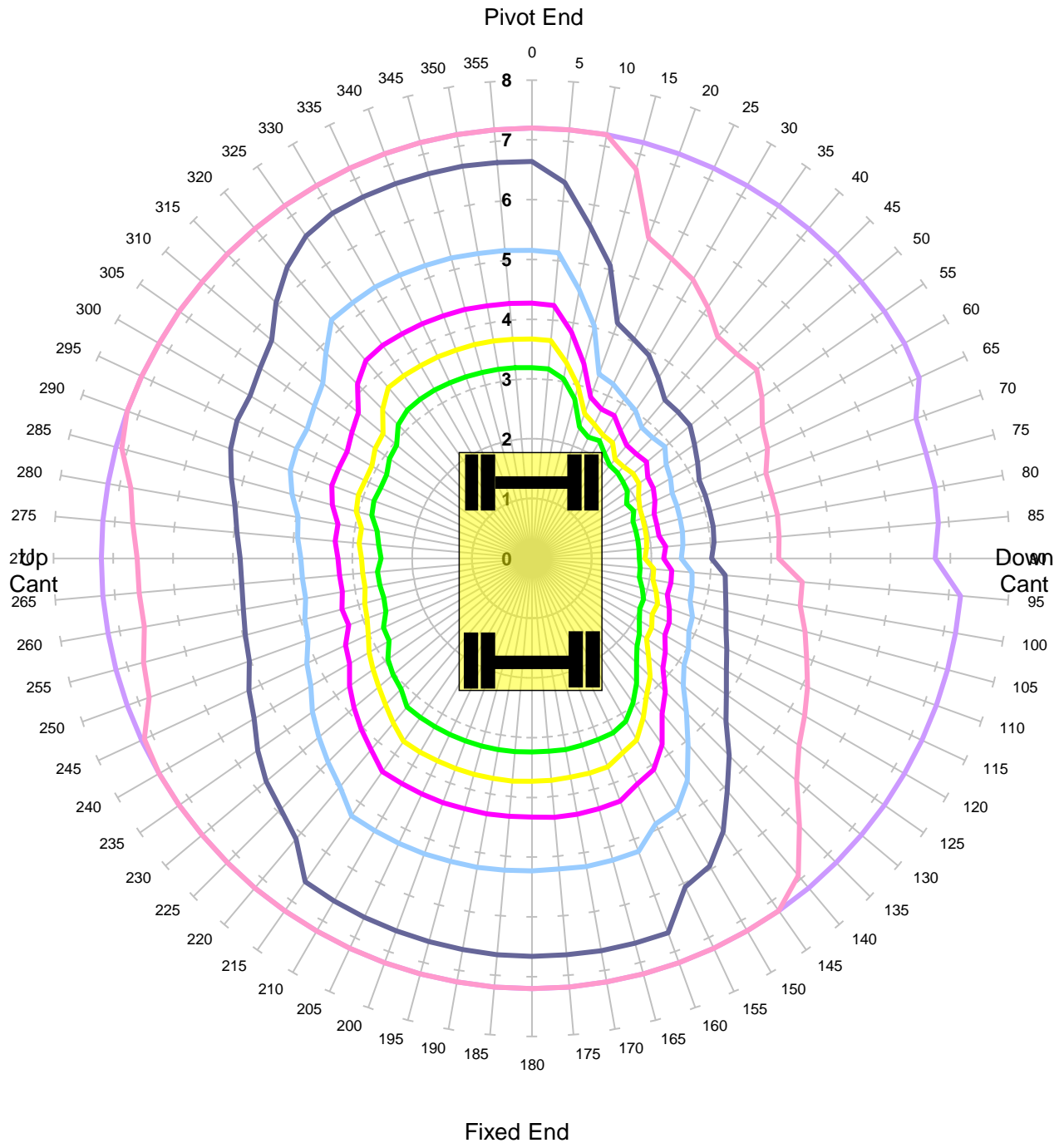

Units in Tonnes

- 1
- 2
- 3
- 4
- 5
- 6
- 7

<b>MACHINE &amp; MODEL:</b>	Komatsu PW160-11	<b>REFERENCE:</b>	3.00m Jib
<b>SERIAL No:</b>	H65234	<b>DATE OF CHART:</b>	12-Oct-2020
<b>EQUIPMENT:</b>	2.00m + 3.47m + 2.50m	<b>SAFETY FACTOR:</b>	59.0%
<b>COMMENT:</b>			

# Komatsu PW160-11

**Max Capacity Contours of Radius(m) Plots 2.5m Dipper  
Gradient 1 in -25 Height 2m Lift ALP1**

**Locked Rail Cant -50mm - Tandem Lift**

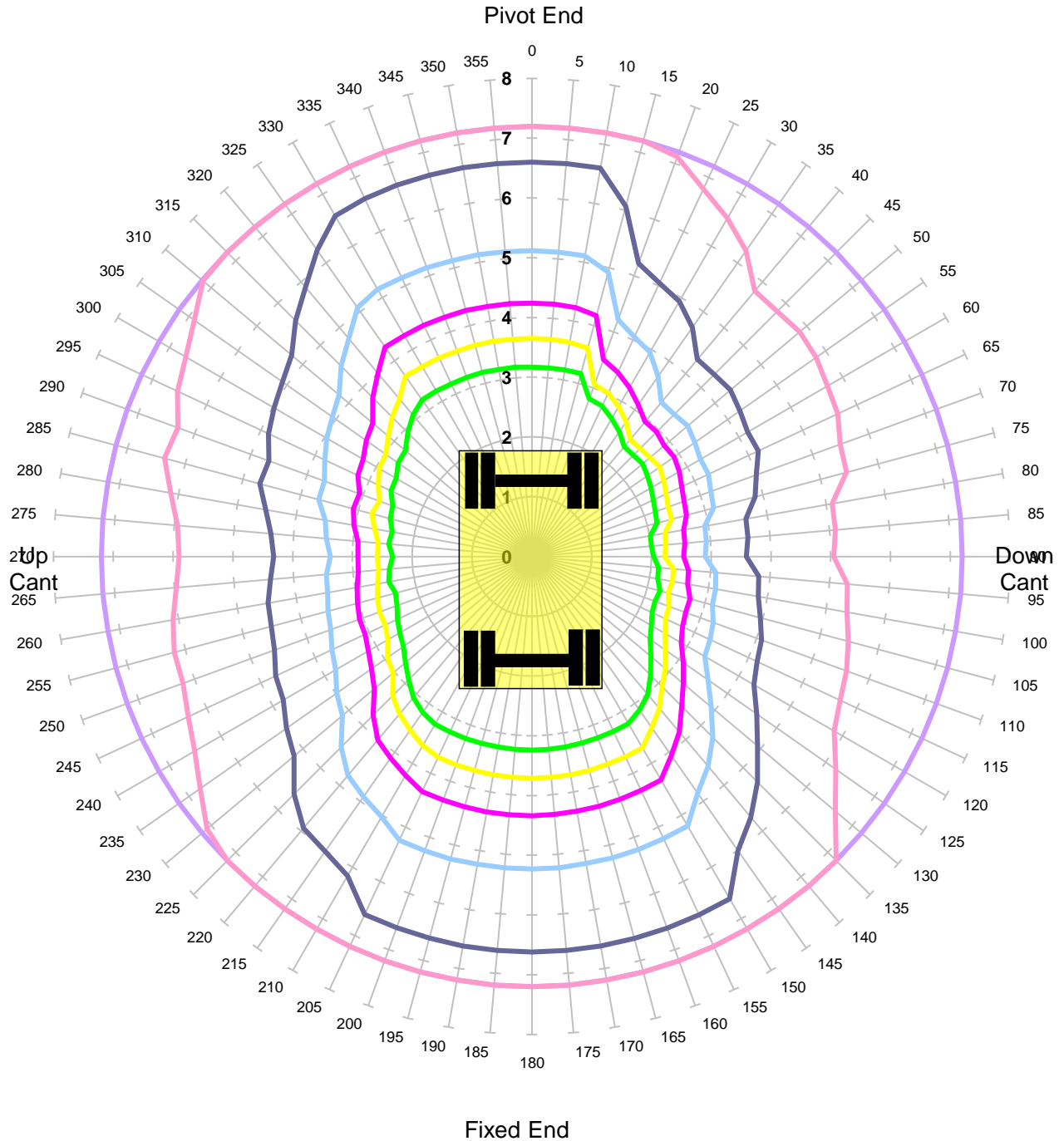

Units in Tonnes

- 1
- 2
- 3
- 4
- 5
- 6
- 7

<b>MACHINE &amp; MODEL:</b>	Komatsu PW160-11	<b>REFERENCE:</b>	3.00m Jib
<b>SERIAL No:</b>	H65234	<b>DATE OF CHART:</b>	12-Oct-2020
<b>EQUIPMENT:</b>	2.00m + 3.47m + 2.50m	<b>SAFETY FACTOR:</b>	59.0%
<b>COMMENT:</b>			

**Komatsu PW160-11**  
**Max Capacity Contours of Radius(m) Plots 2.5m Dipper**  
**Gradient 1 in -25 Height 2m Lift ALP1**  
**Locked Rail Cant 50mm - Tandem Lift**

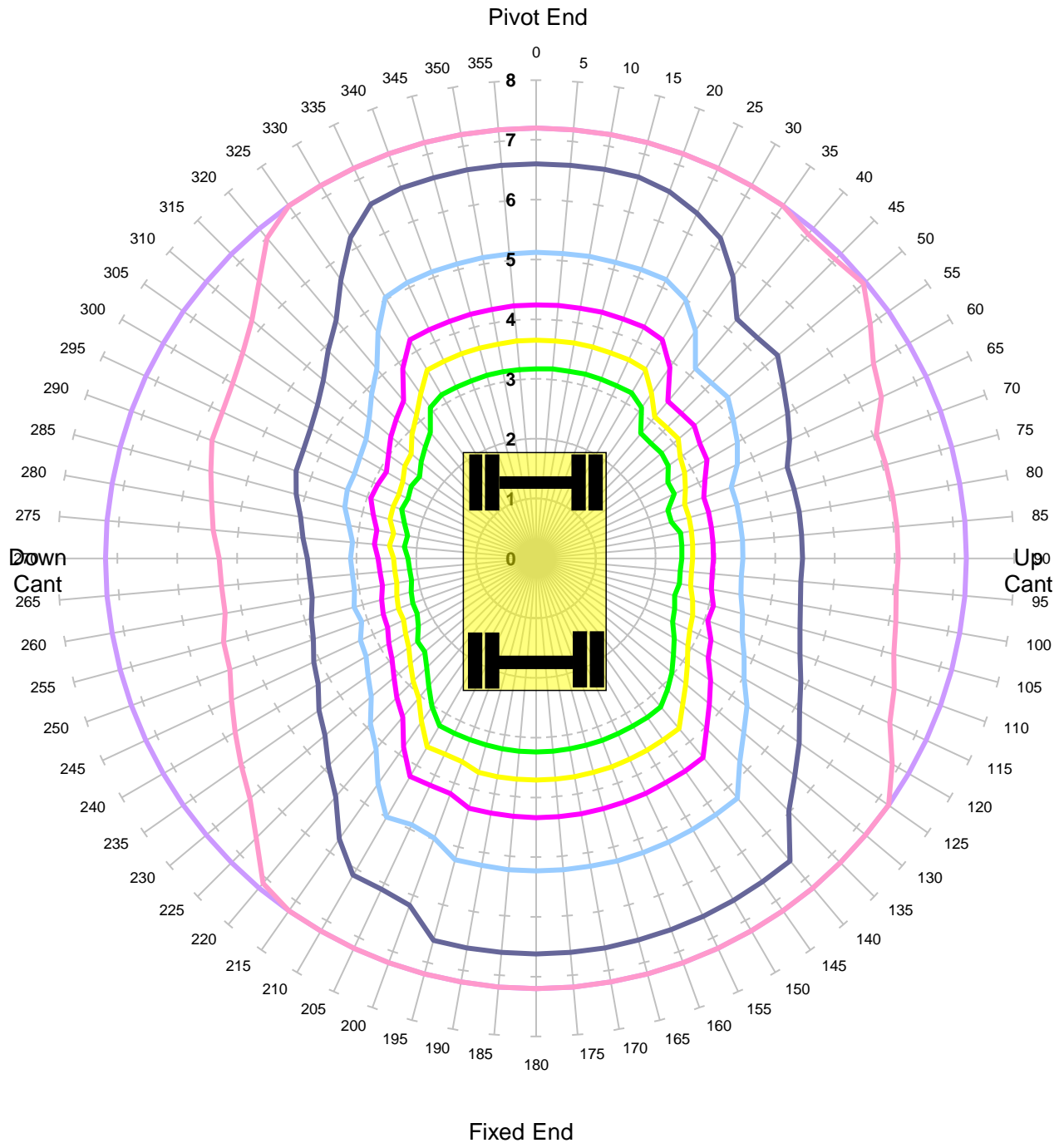

Units in Tonnes

- 1
- 2
- 3
- 4
- 5
- 6
- 7

<b>MACHINE &amp; MODEL:</b>	Komatsu PW160-11	<b>REFERENCE:</b>	3.00m Jib
<b>SERIAL No:</b>	H65234	<b>DATE OF CHART:</b>	12-Oct-2020
<b>EQUIPMENT:</b>	2.00m + 3.47m + 2.50m	<b>SAFETY FACTOR:</b>	59.0%
<b>COMMENT:</b>			

# Komatsu PW160-11

**Max Capacity Contours of Radius(m) Plots 2.5m Dipper  
Gradient 1 in -25 Height 2m Lift ALP1**

**Locked Rail Cant 150mm - Tandem Lift**

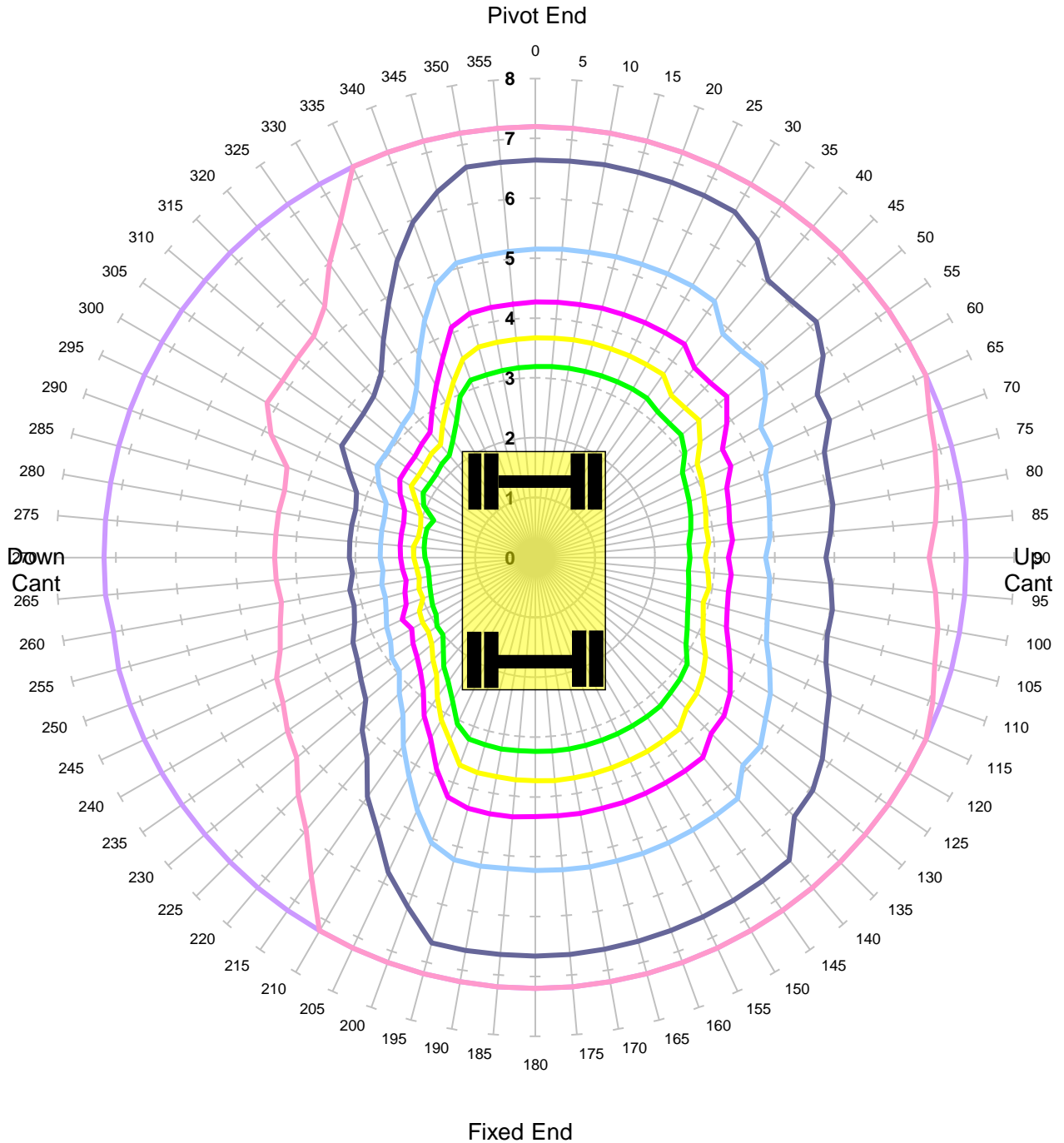

Units in Tonnes

- 1
- 2
- 3
- 4
- 5
- 6
- 7

<b>MACHINE &amp; MODEL:</b>	Komatsu PW160-11	<b>REFERENCE:</b>	3.00m Jib
<b>SERIAL No:</b>	H65234	<b>DATE OF CHART:</b>	12-Oct-2020
<b>EQUIPMENT:</b>	2.00m + 3.47m + 2.50m	<b>SAFETY FACTOR:</b>	59.0%
<b>COMMENT:</b>			



**Komatsu PW160-11**  
**Max Capacity Contours of Radius(m) Plots 2.5m Dipper**  
**Level Ground Height 2m Lift ALP1**  
**Unlocked Road - Tandem Lift**

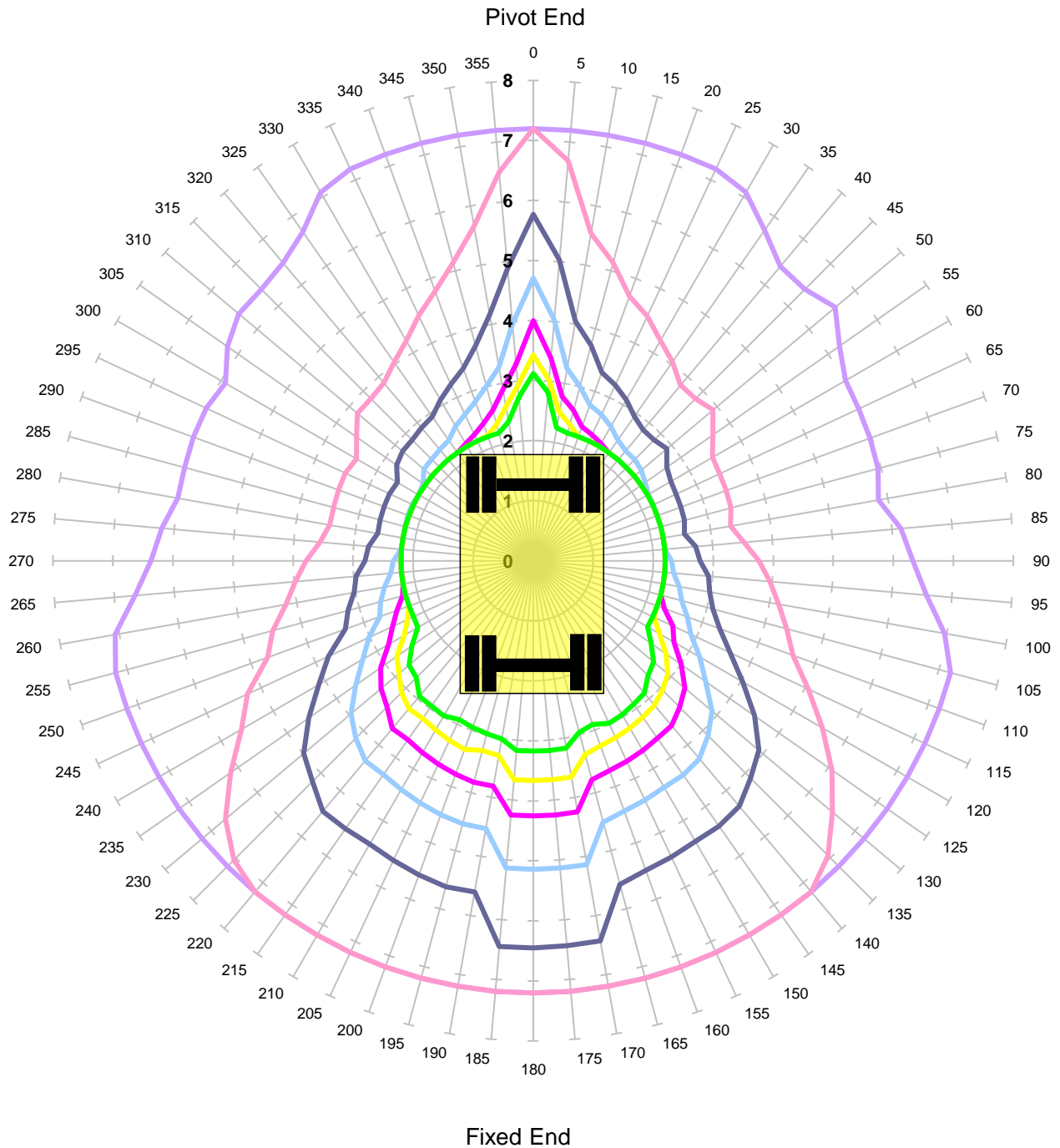

Units in Tonnes

- 1   
 — 2   
 — 3   
 — 4   
 — 5   
 — 6   
 — 7

<b>MACHINE &amp; MODEL:</b>	Komatsu PW160-11	<b>REFERENCE:</b>	3.00m Jib
<b>SERIAL No:</b>	H65234	<b>DATE OF CHART:</b>	12-Oct-2020
<b>EQUIPMENT:</b>	2.00m + 3.47m + 2.50m	<b>SAFETY FACTOR:</b>	47.0%
<b>COMMENT:</b>			

**Komatsu PW160-11**  
**Max Capacity Contours of Radius(m) Plots 2.5m Dipper**  
**Level Ground Height 2m Lift ALP1**  
**Locked Road - Tandem Lift**

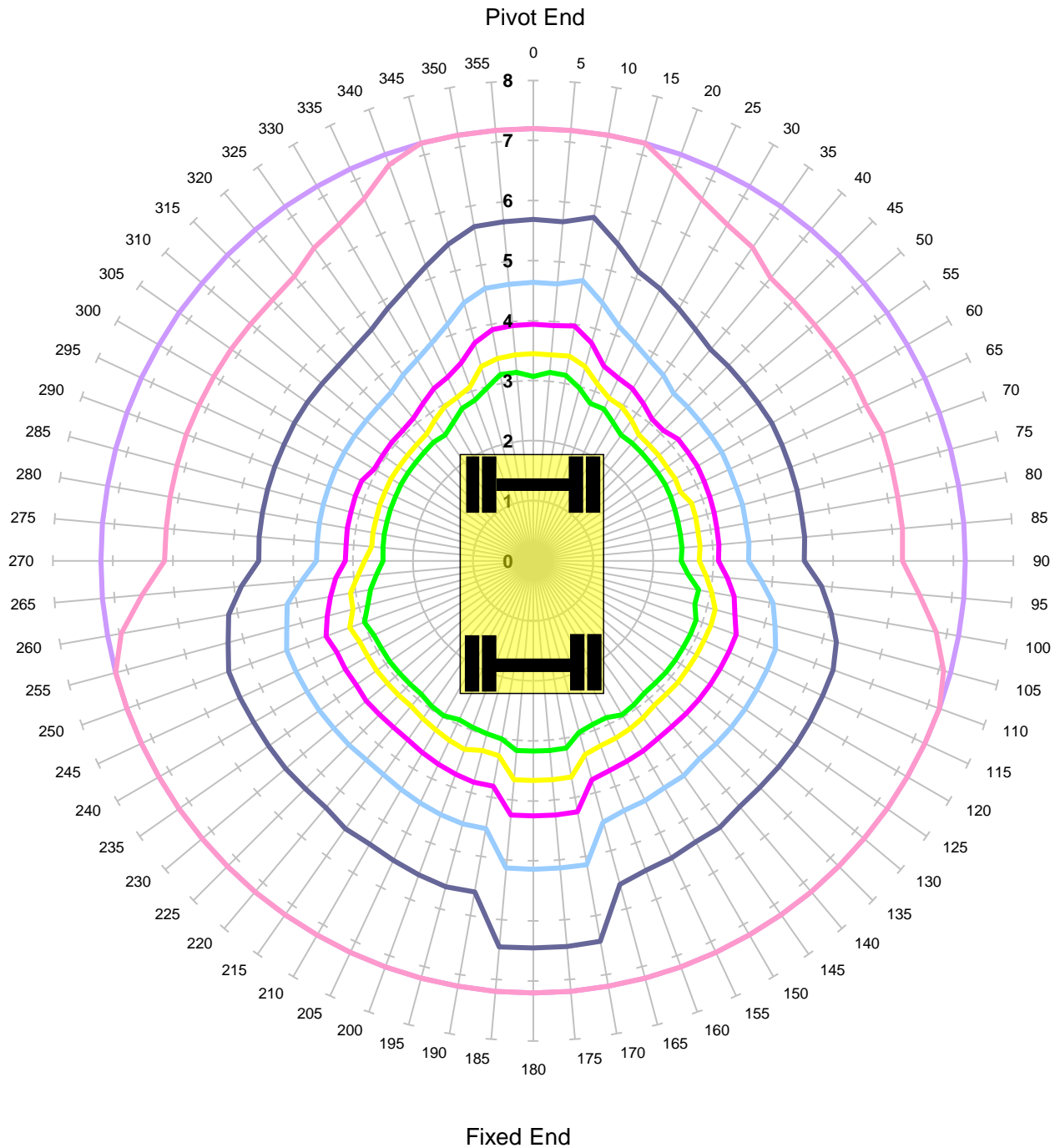

Units in Tonnes

- 1   
 — 2   
 — 3   
 — 4   
 — 5   
 — 6   
 — 7

<b>MACHINE &amp; MODEL:</b>	Komatsu PW160-11	<b>REFERENCE:</b>	3.00m Jib
<b>SERIAL No:</b>	H65234	<b>DATE OF CHART:</b>	12-Oct-2020
<b>EQUIPMENT:</b>	2.00m + 3.47m + 2.50m	<b>SAFETY FACTOR:</b>	47.0%
<b>COMMENT:</b>			

**Komatsu PW160-11**  
**Max Capacity Contours of Radius(m) Plots 2.5m Dipper**  
**Gradient 1 in -25 Height 2m Lift QH**  
**Unlocked Rail Cant -150mm**

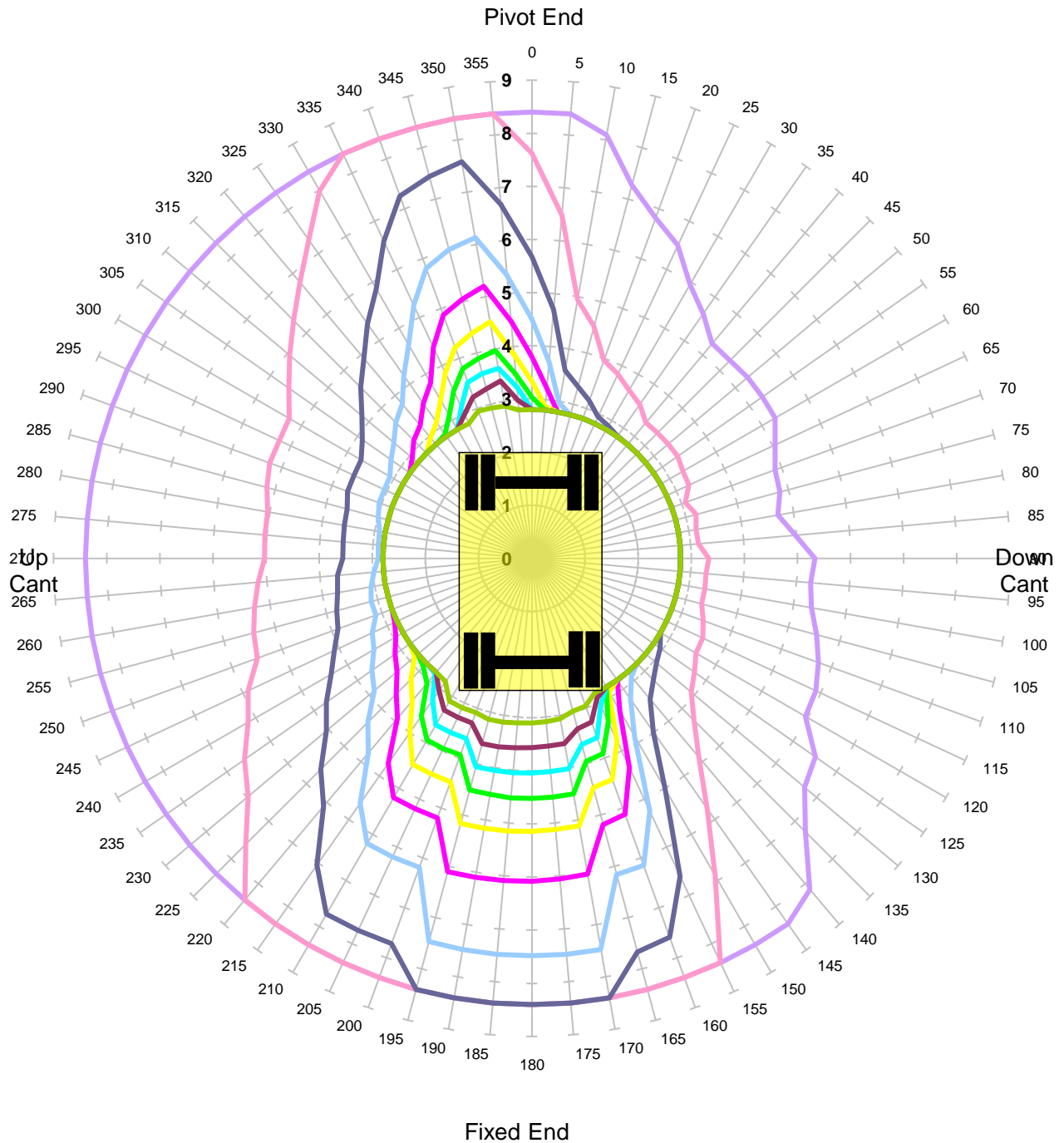

Units in Tonnes

- 1
- 2
- 3
- 4
- 5
- 6
- 7
- 8
- 9
- 10

<b>MACHINE &amp; MODEL:</b>	Komatsu PW160-11	<b>REFERENCE:</b>	3.00m Jib
<b>SERIAL No:</b>	H65234	<b>DATE OF CHART:</b>	12-Oct-2020
<b>EQUIPMENT:</b>	2.00m + 3.47m + 2.50m	<b>SAFETY FACTOR:</b>	67.0%
<b>COMMENT:</b>			

**Komatsu PW160-11**  
**Max Capacity Contours of Radius(m) Plots 2.5m Dipper**  
**Gradient 1 in -25 Height 2m Lift QH**  
**Unlocked Rail Cant -50mm**

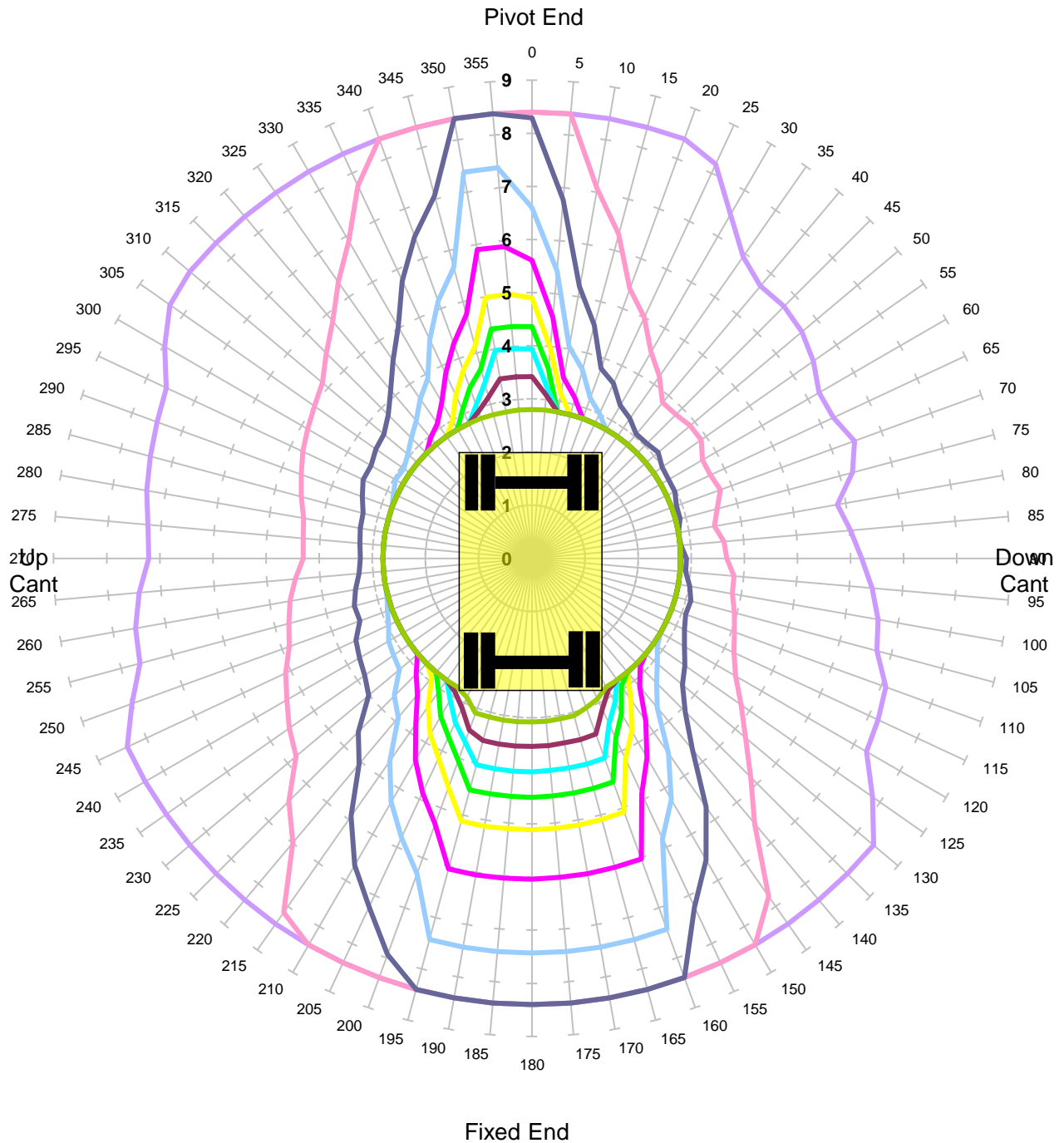

Units in Tonnes

- 1
- 2
- 3
- 4
- 5
- 6
- 7
- 8
- 9
- 10

<b>MACHINE &amp; MODEL:</b>	Komatsu PW160-11	<b>REFERENCE:</b>	3.00m Jib
<b>SERIAL No:</b>	H65234	<b>DATE OF CHART:</b>	12-Oct-2020
<b>EQUIPMENT:</b>	2.00m + 3.47m + 2.50m	<b>SAFETY FACTOR:</b>	67.0%
<b>COMMENT:</b>			

**Komatsu PW160-11**  
**Max Capacity Contours of Radius(m) Plots 2.5m Dipper**  
**Gradient 1 in -25 Height 2m Lift QH**  
**Unlocked Rail Cant 50mm**

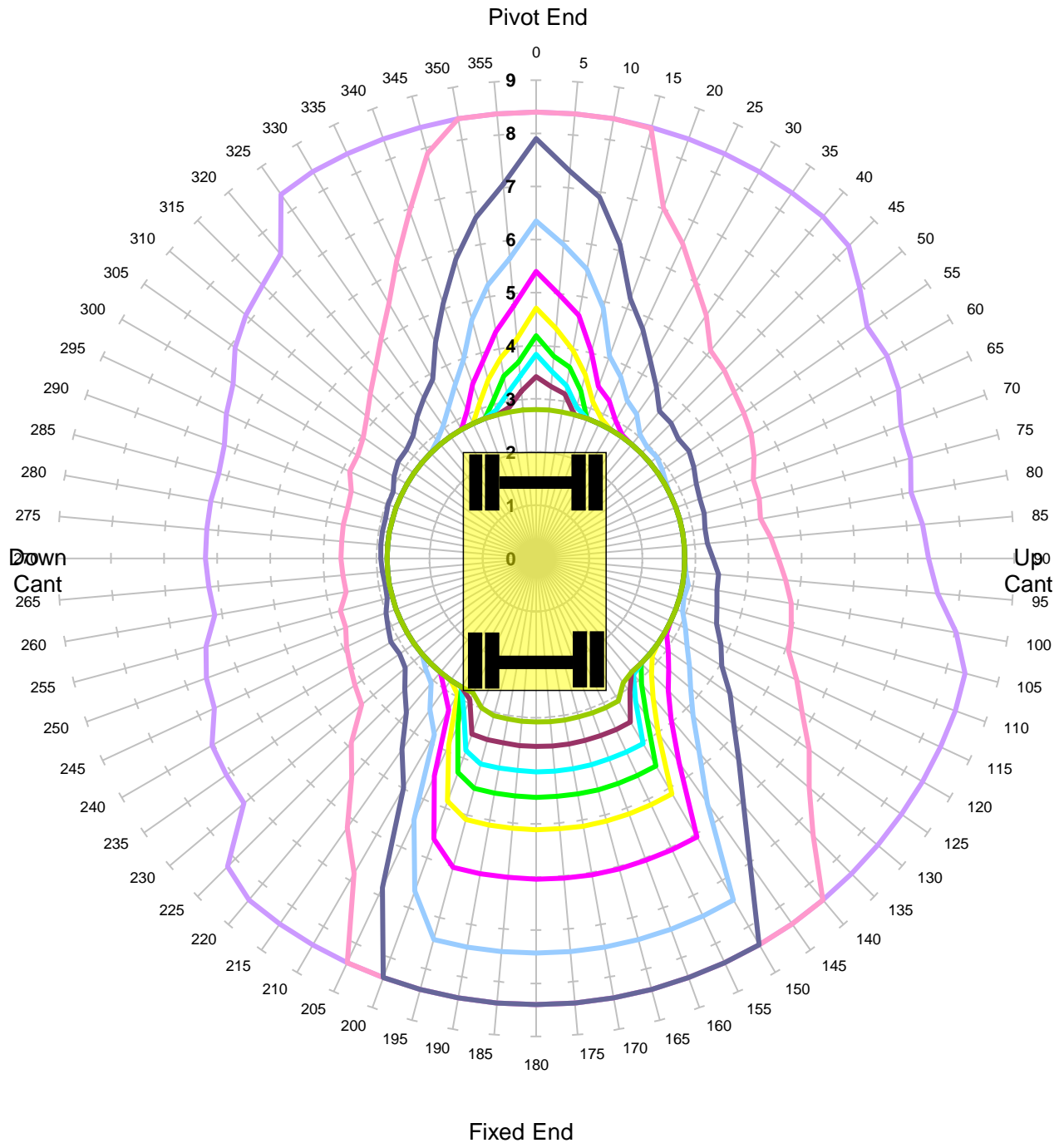

Units in Tonnes

- 1
- 2
- 3
- 4
- 5
- 6
- 7
- 8
- 9
- 10

<b>MACHINE &amp; MODEL:</b>	Komatsu PW160-11	<b>REFERENCE:</b>	3.00m Jib
<b>SERIAL No:</b>	H65234	<b>DATE OF CHART:</b>	12-Oct-2020
<b>EQUIPMENT:</b>	2.00m + 3.47m + 2.50m	<b>SAFETY FACTOR:</b>	67.0%
<b>COMMENT:</b>			

**Komatsu PW160-11**  
**Max Capacity Contours of Radius(m) Plots 2.5m Dipper**  
**Gradient 1 in -25 Height 2m Lift QH**  
**Unlocked Rail Cant 150mm**

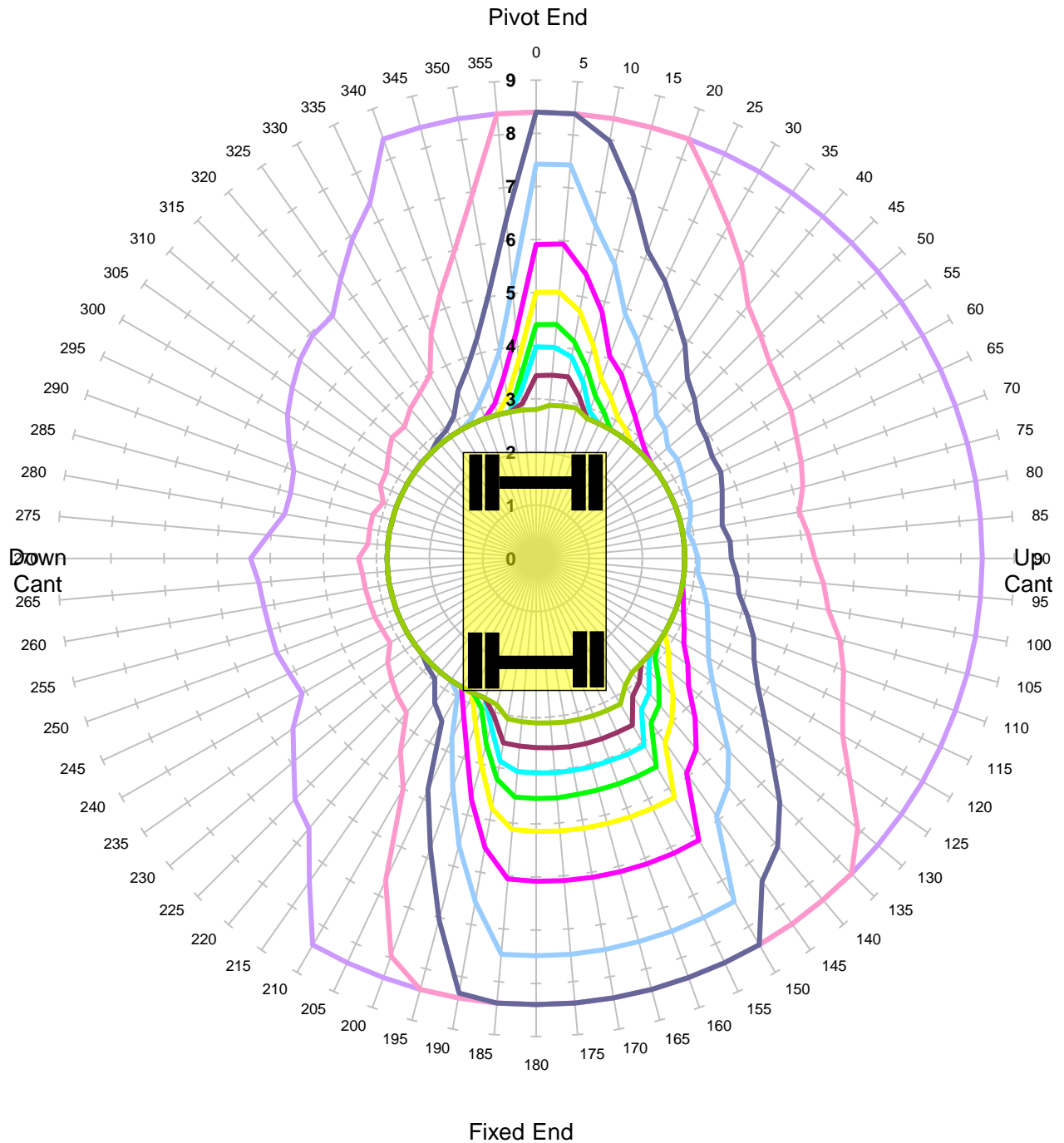

Units in Tonnes

- 1
- 2
- 3
- 4
- 5
- 6
- 7
- 8
- 9
- 10

<b>MACHINE &amp; MODEL:</b>	Komatsu PW160-11	<b>REFERENCE:</b>	3.00m Jib
<b>SERIAL No:</b>	H65234	<b>DATE OF CHART:</b>	12-Oct-2020
<b>EQUIPMENT:</b>	2.00m + 3.47m + 2.50m	<b>SAFETY FACTOR:</b>	67.0%
<b>COMMENT:</b>			



**Komatsu PW160-11**  
**Max Capacity Contours of Radius(m) Plots 2.5m Dipper**  
**Gradient 1 in -25 Height 2m Lift QH**  
**Locked Rail Cant -150mm**

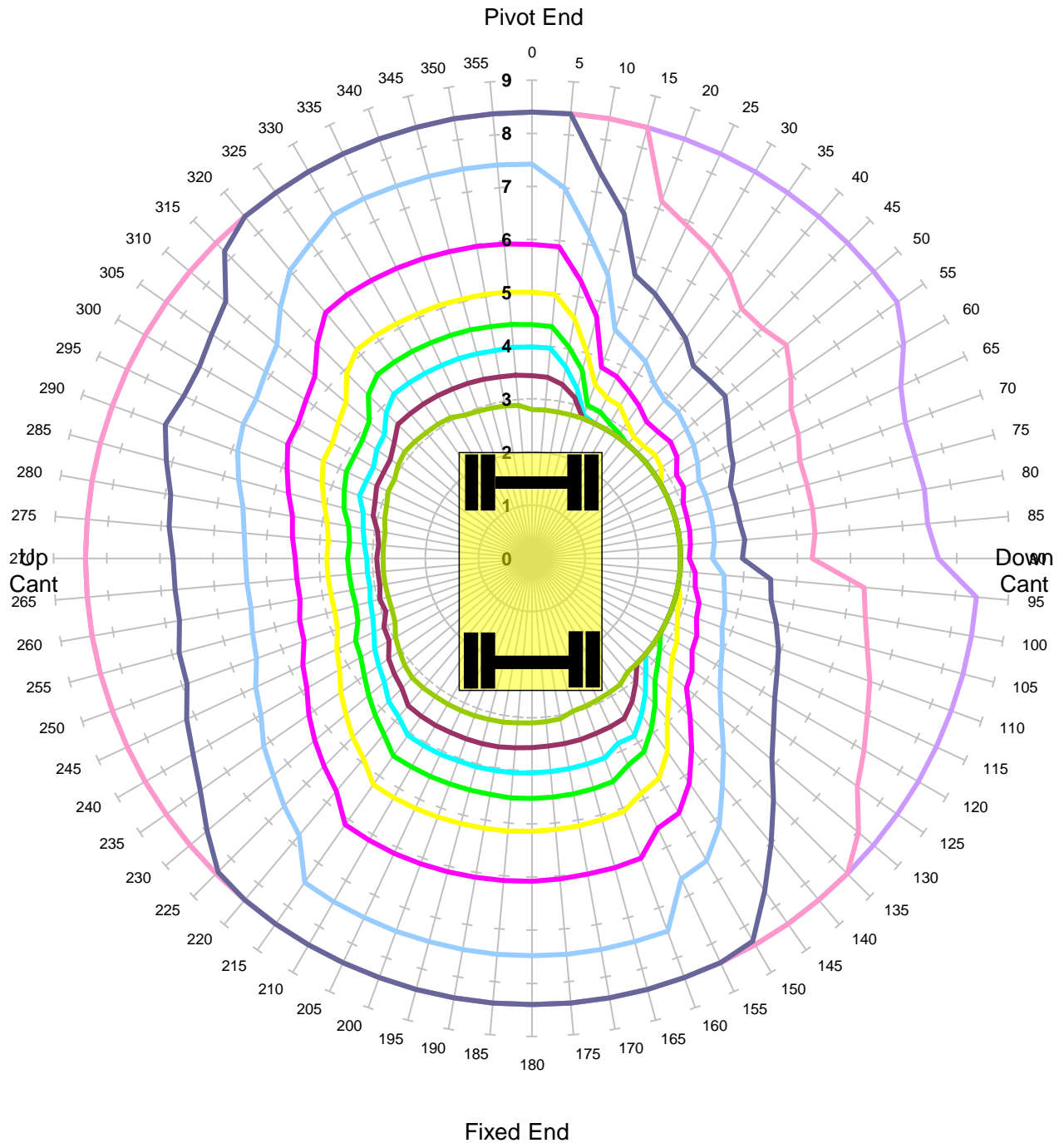

Units in Tonnes

- 1
- 2
- 3
- 4
- 5
- 6
- 7
- 8
- 9
- 10

<b>MACHINE &amp; MODEL:</b>	Komatsu PW160-11	<b>REFERENCE:</b>	3.00m Jib
<b>SERIAL No:</b>	H65234	<b>DATE OF CHART:</b>	12-Oct-2020
<b>EQUIPMENT:</b>	2.00m + 3.47m + 2.50m	<b>SAFETY FACTOR:</b>	90.0%
<b>COMMENT:</b>			

**Komatsu PW160-11**  
**Max Capacity Contours of Radius(m) Plots 2.5m Dipper**  
**Gradient 1 in -25 Height 2m Lift QH**  
**Locked Rail Cant -50mm**

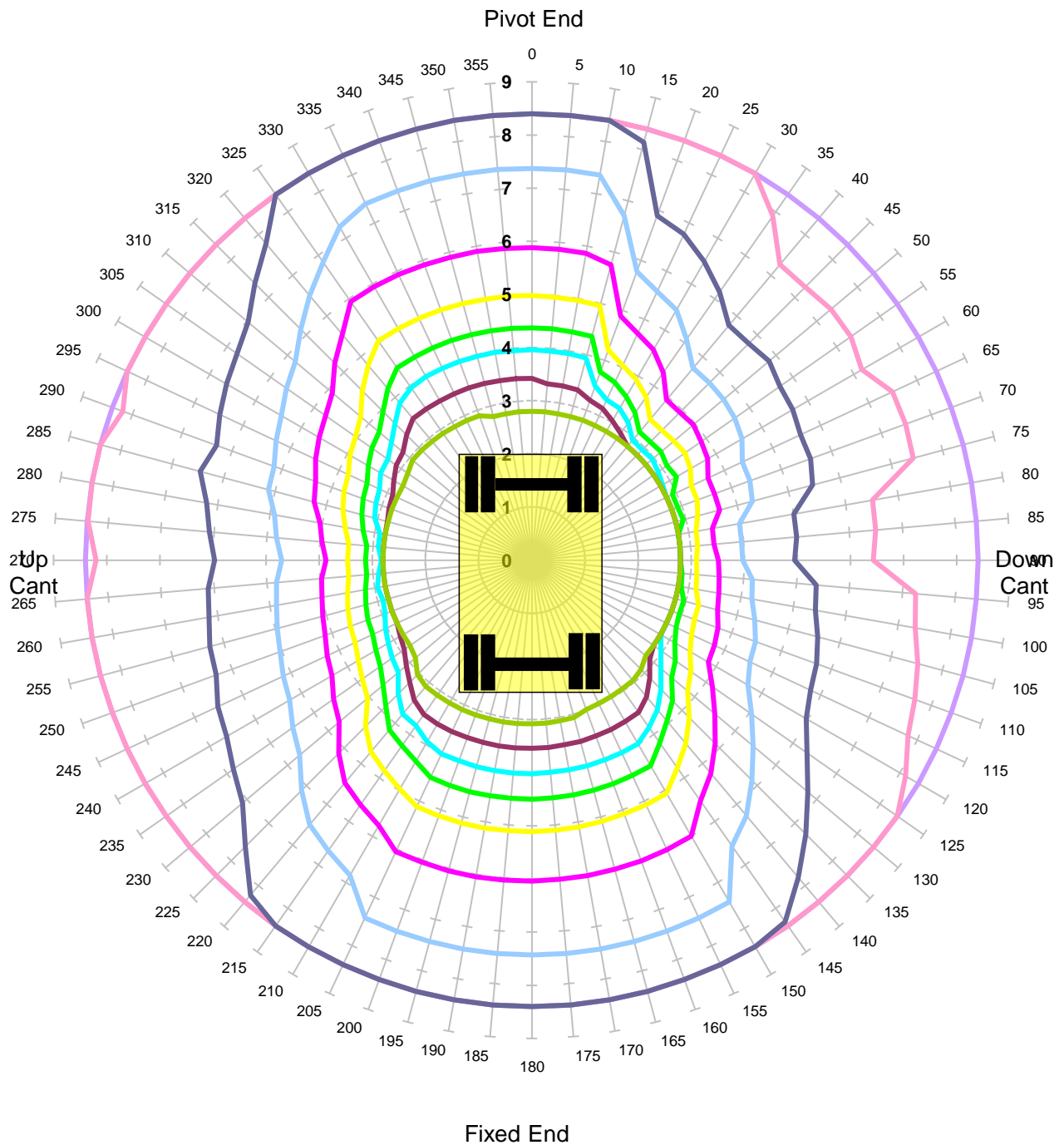

Units in Tonnes

- 1
- 2
- 3
- 4
- 5
- 6
- 7
- 8
- 9
- 10

<b>MACHINE &amp; MODEL:</b>	Komatsu PW160-11	<b>REFERENCE:</b>	3.00m Jib
<b>SERIAL No:</b>	H65234	<b>DATE OF CHART:</b>	12-Oct-2020
<b>EQUIPMENT:</b>	2.00m + 3.47m + 2.50m	<b>SAFETY FACTOR:</b>	90.0%
<b>COMMENT:</b>			

**Komatsu PW160-11**  
**Max Capacity Contours of Radius(m) Plots 2.5m Dipper**  
**Gradient 1 in -25 Height 2m Lift QH**  
**Locked Rail Cant 50mm**

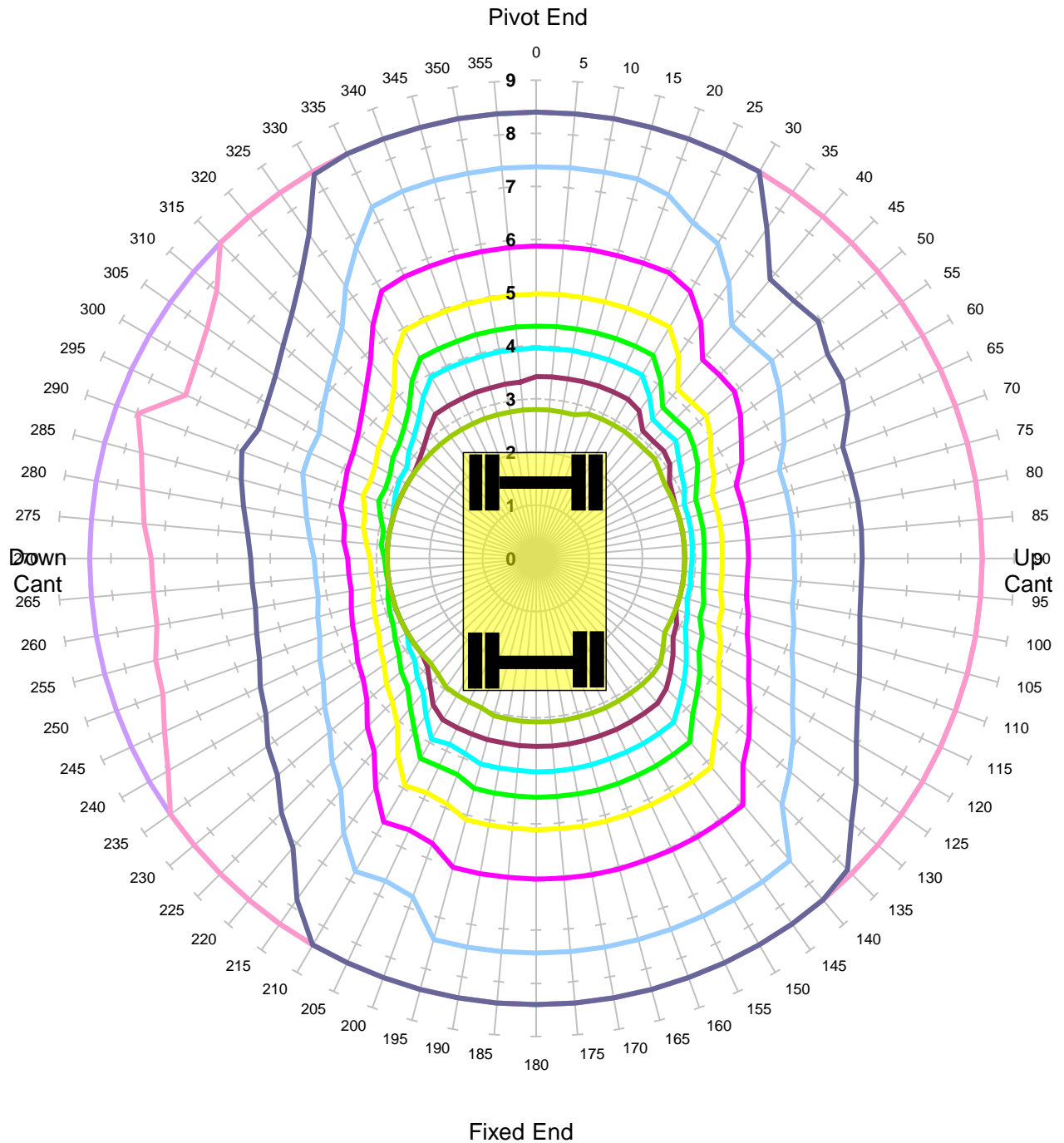

Units in Tonnes

- 1
- 2
- 3
- 4
- 5
- 6
- 7
- 8
- 9
- 10

<b>MACHINE &amp; MODEL:</b>	Komatsu PW160-11	<b>REFERENCE:</b>	3.00m Jib
<b>SERIAL No:</b>	H65234	<b>DATE OF CHART:</b>	12-Oct-2020
<b>EQUIPMENT:</b>	2.00m + 3.47m + 2.50m	<b>SAFETY FACTOR:</b>	90.0%
<b>COMMENT:</b>			

**Komatsu PW160-11**  
**Max Capacity Contours of Radius(m) Plots 2.5m Dipper**  
**Gradient 1 in -25 Height 2m Lift QH**  
**Locked Rail Cant 150mm**

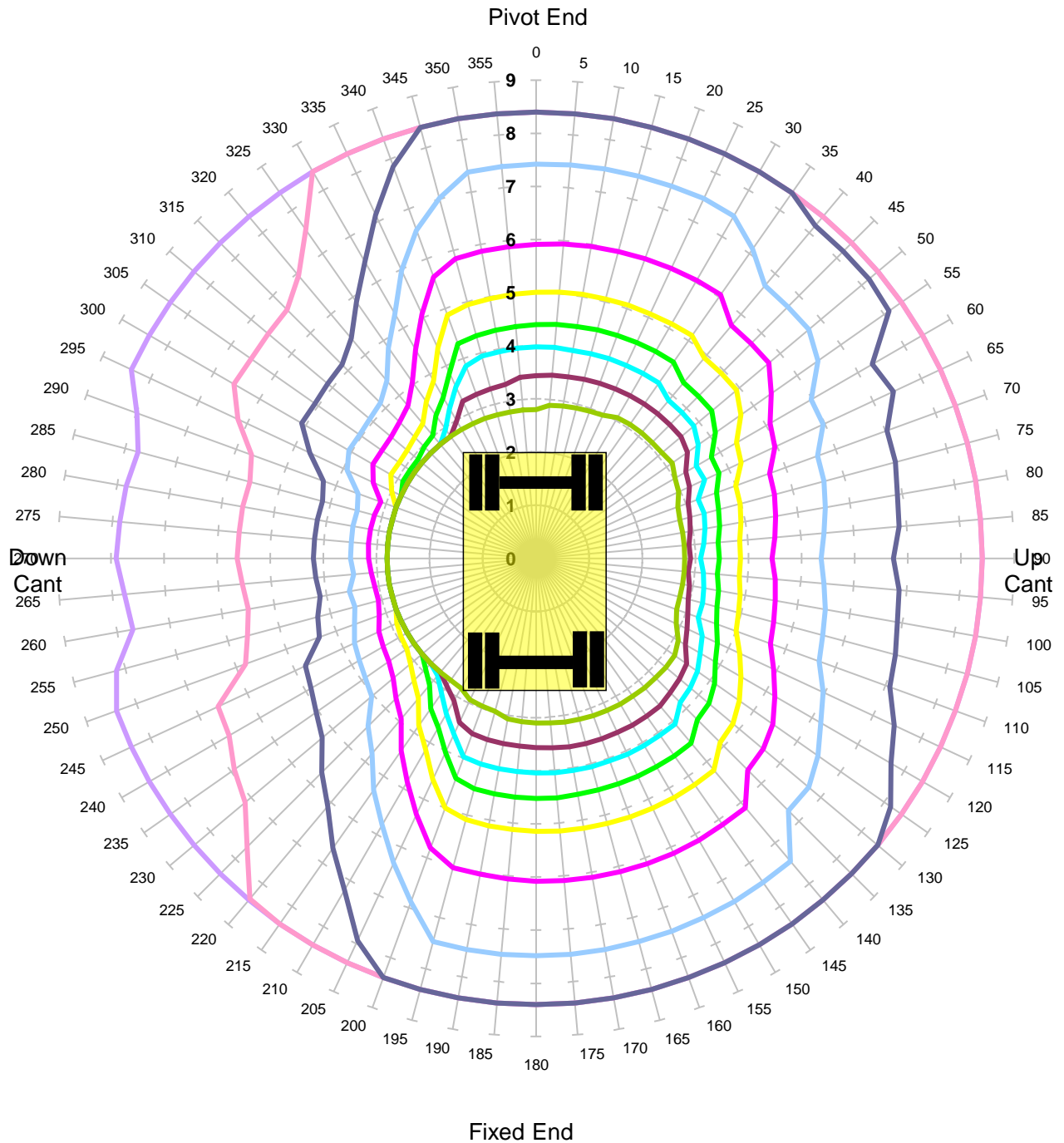

Units in Tonnes

- 1
- 2
- 3
- 4
- 5
- 6
- 7
- 8
- 9
- 10

<b>MACHINE &amp; MODEL:</b>	Komatsu PW160-11	<b>REFERENCE:</b>	3.00m Jib
<b>SERIAL No:</b>	H65234	<b>DATE OF CHART:</b>	12-Oct-2020
<b>EQUIPMENT:</b>	2.00m + 3.47m + 2.50m	<b>SAFETY FACTOR:</b>	90.0%
<b>COMMENT:</b>			

**Komatsu PW160-11**  
**Max Capacity Contours of Radius(m) Plots 2.5m Dipper**  
**Level Ground Height 2m Lift QH**  
**Unlocked Road**

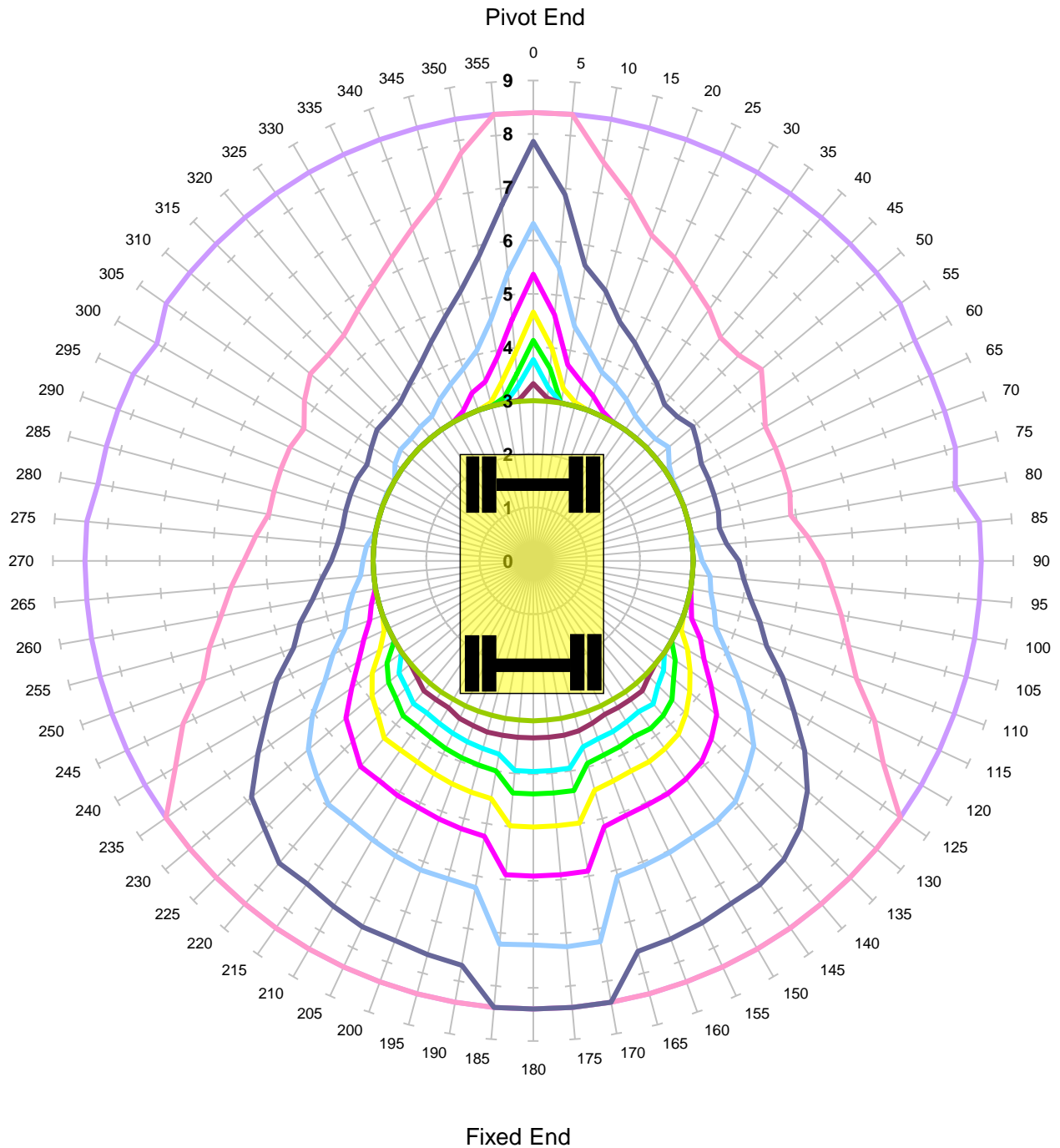

Units in Tonnes

- 1
- 2
- 3
- 4
- 5
- 6
- 7
- 8
- 9
- 10

<b>MACHINE &amp; MODEL:</b>	Komatsu PW160-11	<b>REFERENCE:</b>	3.00m Jib
<b>SERIAL No:</b>	H65234	<b>DATE OF CHART:</b>	12-Oct-2020
<b>EQUIPMENT:</b>	2.00m + 3.47m + 2.50m	<b>SAFETY FACTOR:</b>	71.0%
<b>COMMENT:</b>			

**Komatsu PW160-11**  
**Max Capacity Contours of Radius(m) Plots 2.5m Dipper**  
**Level Ground Height 2m Lift QH**  
**Locked Road**

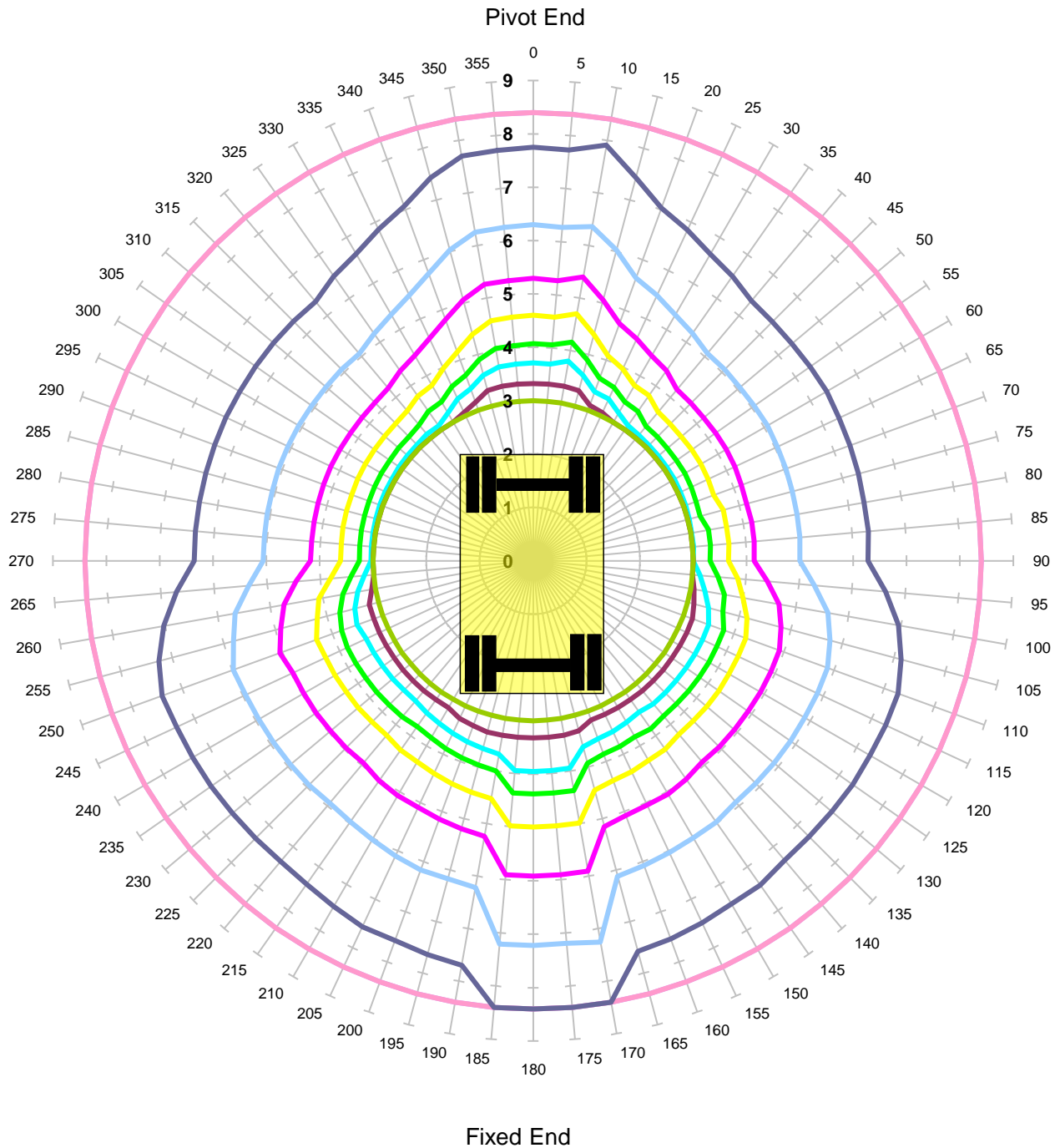

Units in Tonnes

- 1
- 2
- 3
- 4
- 5
- 6
- 7
- 8
- 9
- 10

<b>MACHINE &amp; MODEL:</b>	Komatsu PW160-11	<b>REFERENCE:</b>	3.00m Jib
<b>SERIAL No:</b>	H65234	<b>DATE OF CHART:</b>	12-Oct-2020
<b>EQUIPMENT:</b>	2.00m + 3.47m + 2.50m	<b>SAFETY FACTOR:</b>	71.0%
<b>COMMENT:</b>			



**Komatsu PW160-11**  
**Max Capacity Contours of Radius(m) Plots 2.5m Dipper**  
**Gradient 1 in -25 Height 2m Lift QH**  
**Unlocked Rail Cant -150mm - Tandem Lift**

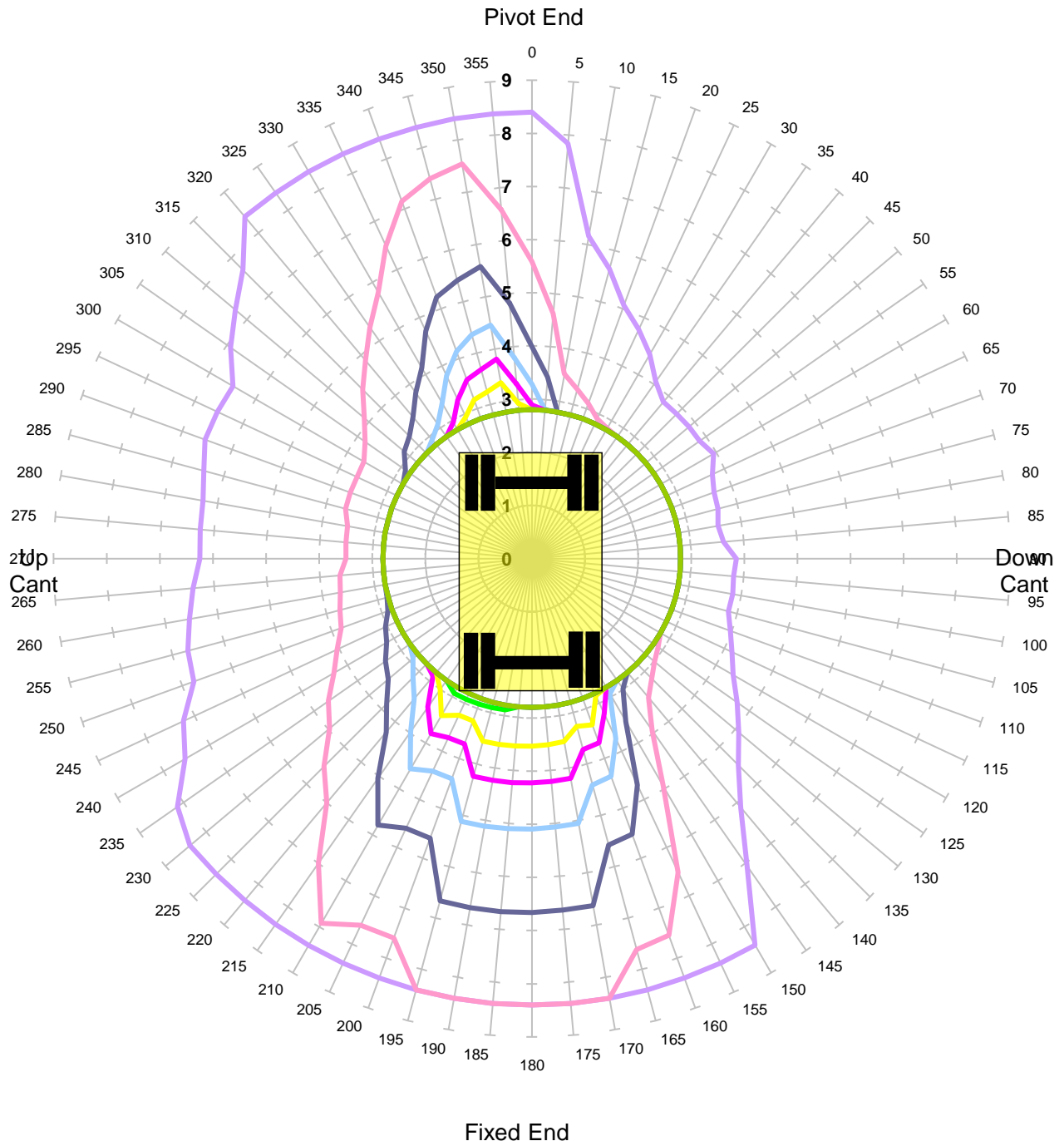

Units in Tonnes

- 1
- 2
- 3
- 4
- 5
- 6
- 7
- 8
- 9
- 10

<b>MACHINE &amp; MODEL:</b>	Komatsu PW160-11	<b>REFERENCE:</b>	3.00m Jib
<b>SERIAL No:</b>	H65234	<b>DATE OF CHART:</b>	12-Oct-2020
<b>EQUIPMENT:</b>	2.00m + 3.47m + 2.50m	<b>SAFETY FACTOR:</b>	44.0%
<b>COMMENT:</b>			

**Komatsu PW160-11**  
**Max Capacity Contours of Radius(m) Plots 2.5m Dipper**  
**Gradient 1 in -25 Height 2m Lift QH**  
**Unlocked Rail Cant -50mm - Tandem Lift**

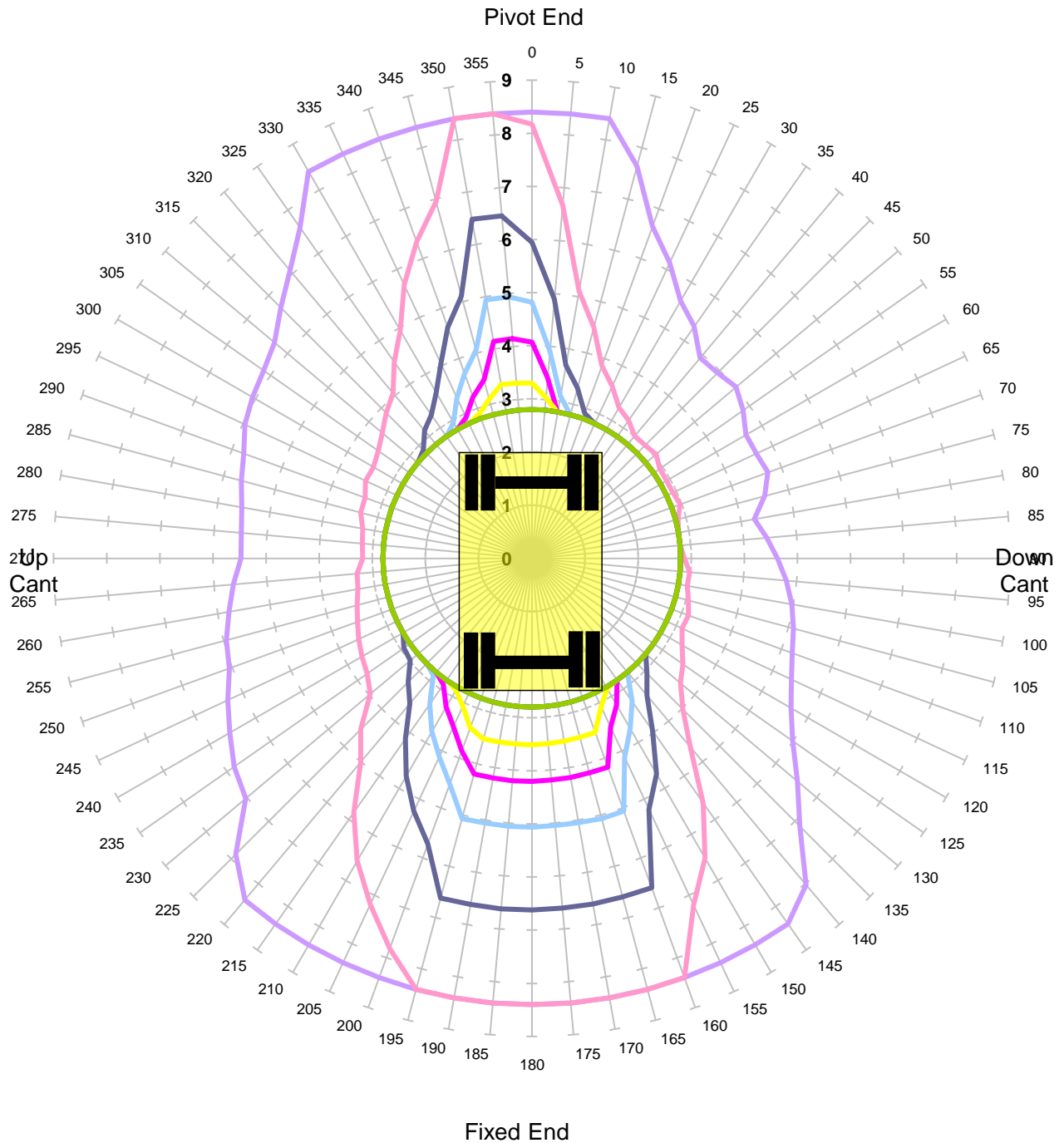

Units in Tonnes

- 1
- 2
- 3
- 4
- 5
- 6
- 7
- 8
- 9
- 10

<b>MACHINE &amp; MODEL:</b>	Komatsu PW160-11	<b>REFERENCE:</b>	3.00m Jib
<b>SERIAL No:</b>	H65234	<b>DATE OF CHART:</b>	12-Oct-2020
<b>EQUIPMENT:</b>	2.00m + 3.47m + 2.50m	<b>SAFETY FACTOR:</b>	44.0%
<b>COMMENT:</b>			

**Komatsu PW160-11**  
**Max Capacity Contours of Radius(m) Plots 2.5m Dipper**  
**Gradient 1 in -25 Height 2m Lift QH**  
**Unlocked Rail Cant 50mm - Tandem Lift**

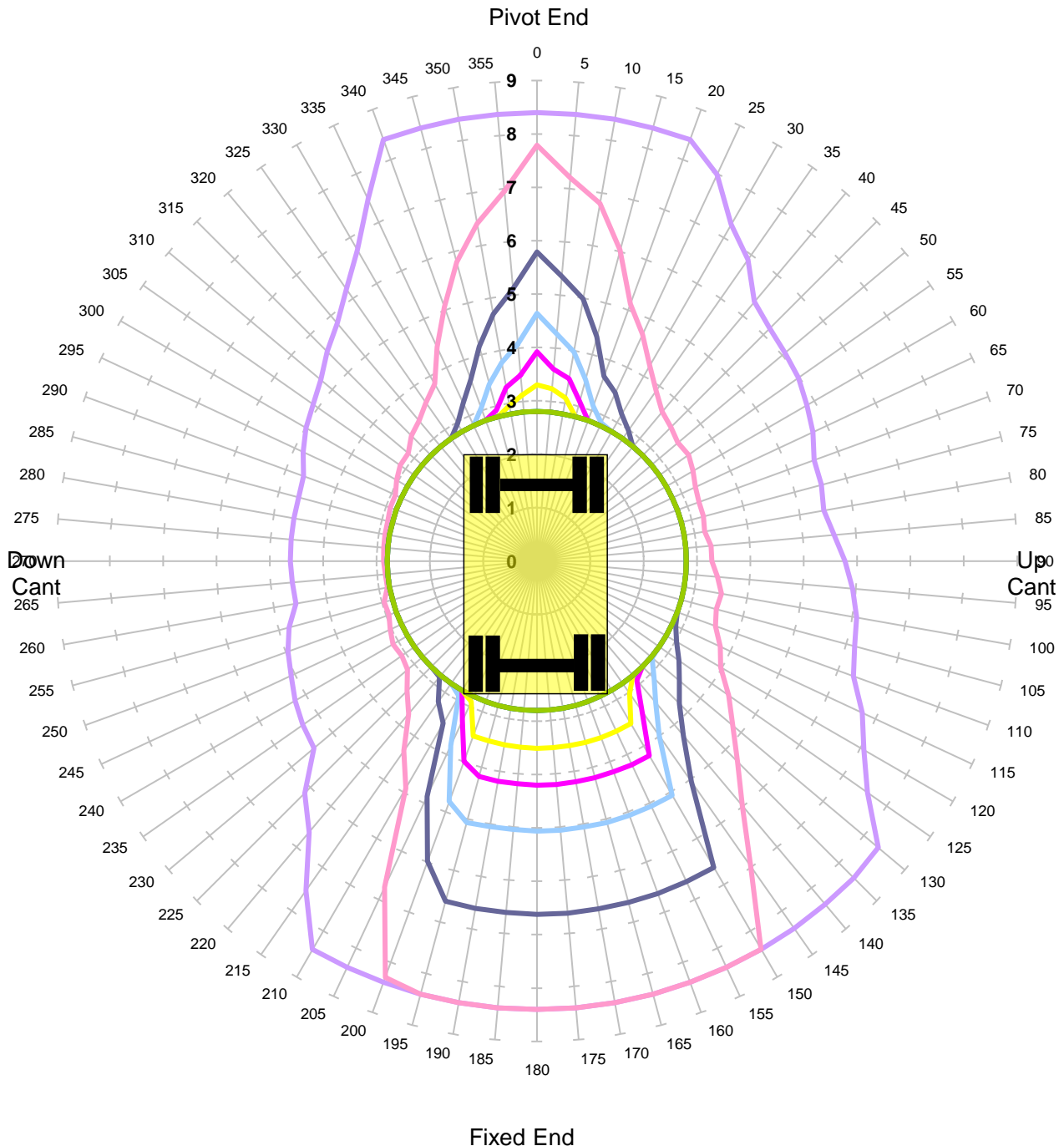

Units in Tonnes

- 1
- 2
- 3
- 4
- 5
- 6
- 7
- 8
- 9
- 10

<b>MACHINE &amp; MODEL:</b>	Komatsu PW160-11	<b>REFERENCE:</b>	3.00m Jib
<b>SERIAL No:</b>	H65234	<b>DATE OF CHART:</b>	12-Oct-2020
<b>EQUIPMENT:</b>	2.00m + 3.47m + 2.50m	<b>SAFETY FACTOR:</b>	44.0%
<b>COMMENT:</b>			

**Komatsu PW160-11**  
**Max Capacity Contours of Radius(m) Plots 2.5m Dipper**  
**Gradient 1 in -25 Height 2m Lift QH**  
**Unlocked Rail Cant 150mm - Tandem Lift**

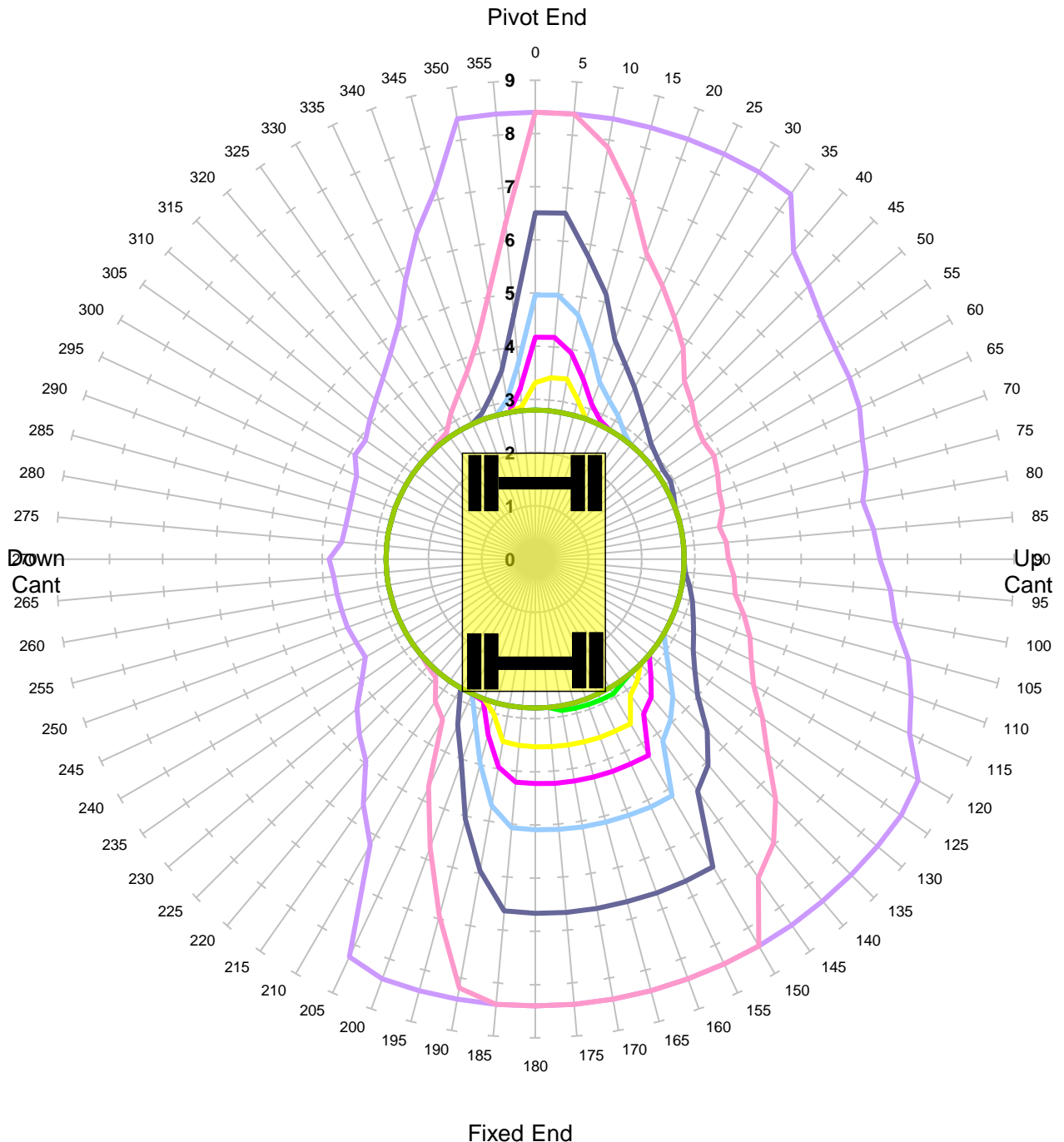

Units in Tonnes

- 1
- 2
- 3
- 4
- 5
- 6
- 7
- 8
- 9
- 10

<b>MACHINE &amp; MODEL:</b>	Komatsu PW160-11	<b>REFERENCE:</b>	3.00m Jib
<b>SERIAL No:</b>	H65234	<b>DATE OF CHART:</b>	12-Oct-2020
<b>EQUIPMENT:</b>	2.00m + 3.47m + 2.50m	<b>SAFETY FACTOR:</b>	44.0%
<b>COMMENT:</b>			

**Komatsu PW160-11**  
**Max Capacity Contours of Radius(m) Plots 2.5m Dipper**  
**Gradient 1 in -25 Height 2m Lift QH**  
**Locked Rail Cant -150mm - Tandem Lift**

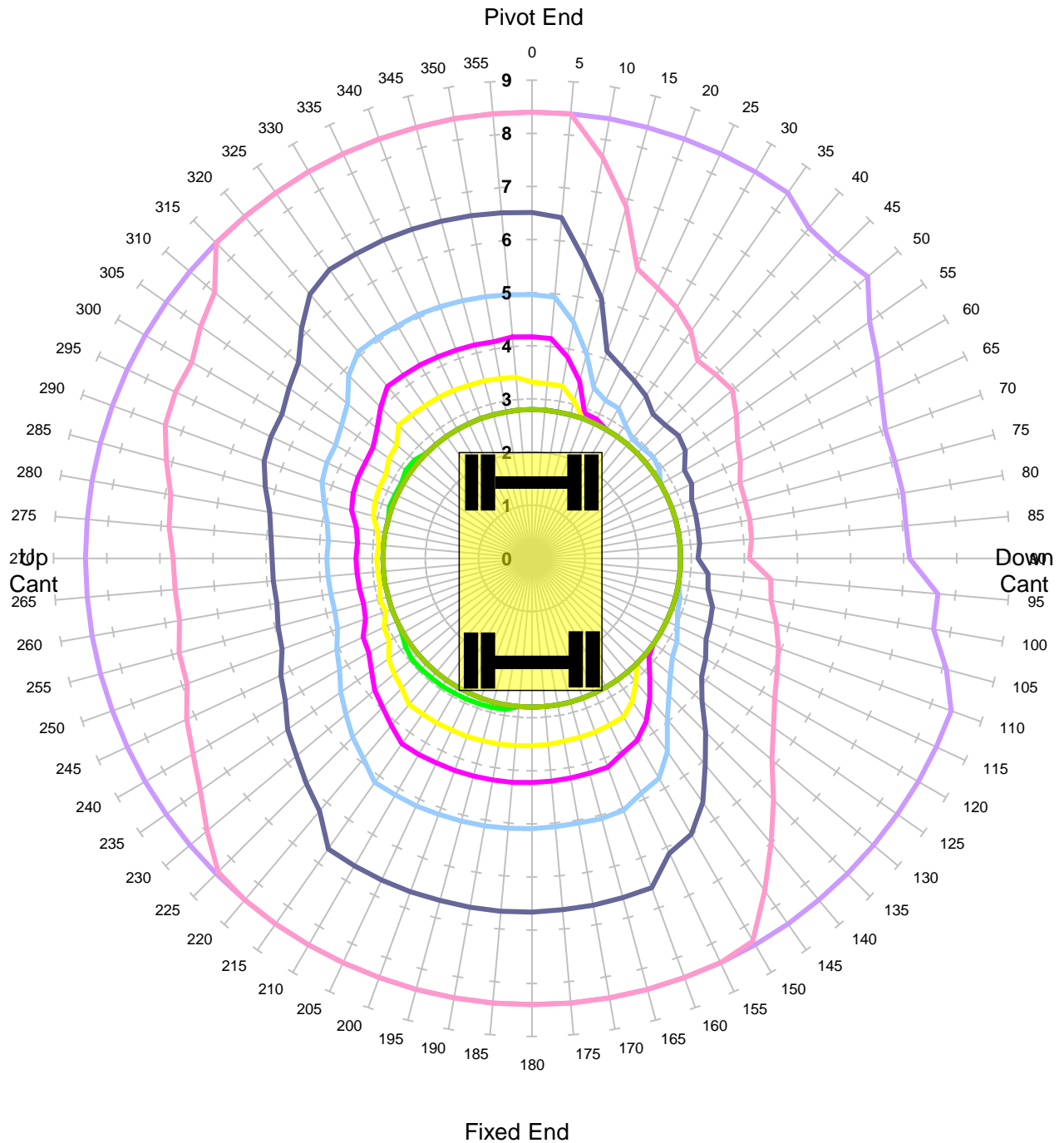

Units in Tonnes

- 1
- 2
- 3
- 4
- 5
- 6
- 7
- 8
- 9
- 10

<b>MACHINE &amp; MODEL:</b>	Komatsu PW160-11	<b>REFERENCE:</b>	3.00m Jib
<b>SERIAL No:</b>	H65234	<b>DATE OF CHART:</b>	12-Oct-2020
<b>EQUIPMENT:</b>	2.00m + 3.47m + 2.50m	<b>SAFETY FACTOR:</b>	59.0%
<b>COMMENT:</b>			

# Komatsu PW160-11

**Max Capacity Contours of Radius(m) Plots 2.5m Dipper  
Gradient 1 in -25 Height 2m Lift QH**

**Locked Rail Cant -50mm - Tandem Lift**

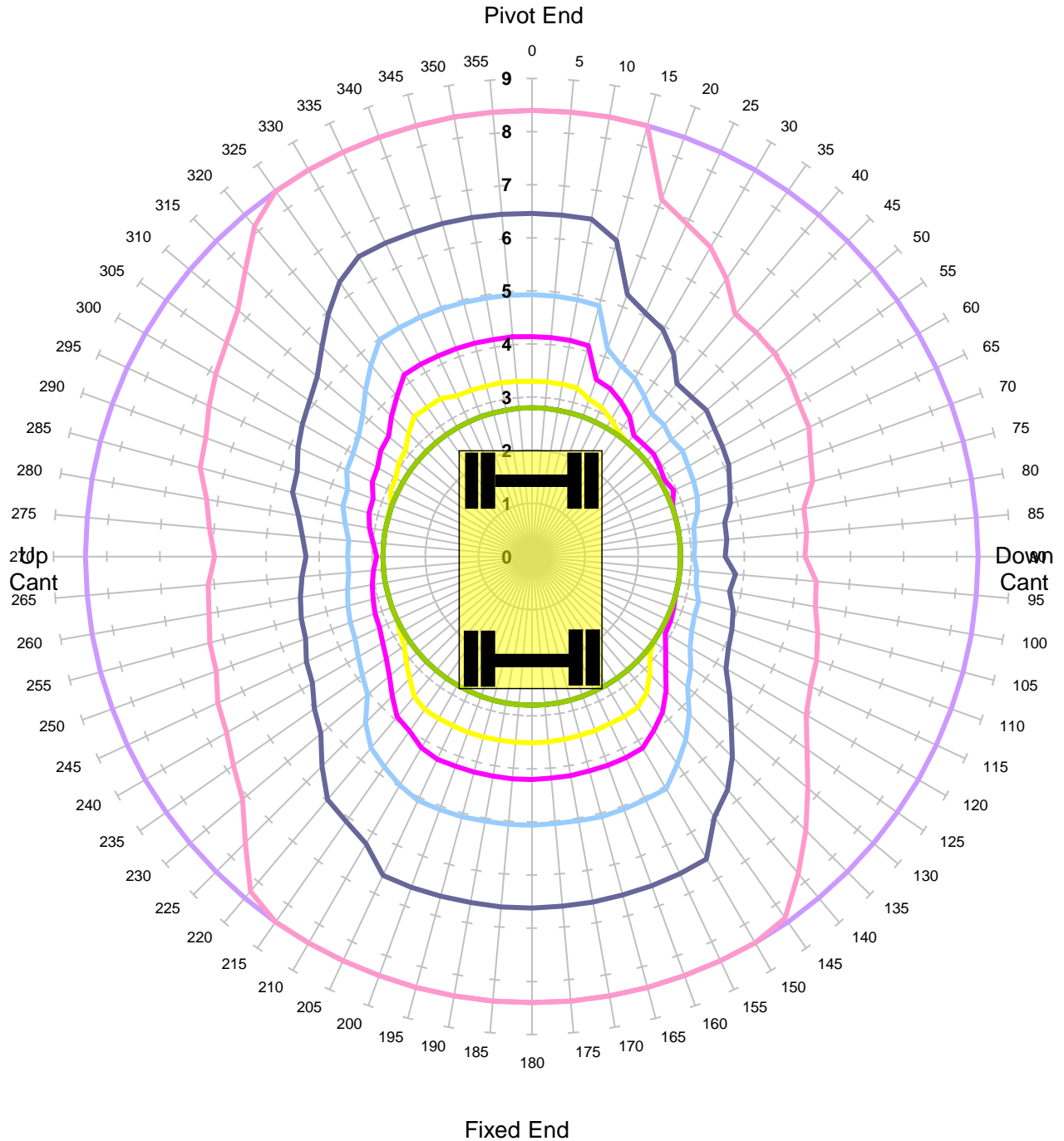

<b>MACHINE &amp; MODEL:</b>	Komatsu PW160-11	<b>REFERENCE:</b>	3.00m Jib
<b>SERIAL No:</b>	H65234	<b>DATE OF CHART:</b>	12-Oct-2020
<b>EQUIPMENT:</b>	2.00m + 3.47m + 2.50m	<b>SAFETY FACTOR:</b>	59.0%
<b>COMMENT:</b>			



# Komatsu PW160-11

**Max Capacity Contours of Radius(m) Plots 2.5m Dipper  
Gradient 1 in -25 Height 2m Lift QH**

**Locked Rail Cant 50mm - Tandem Lift**

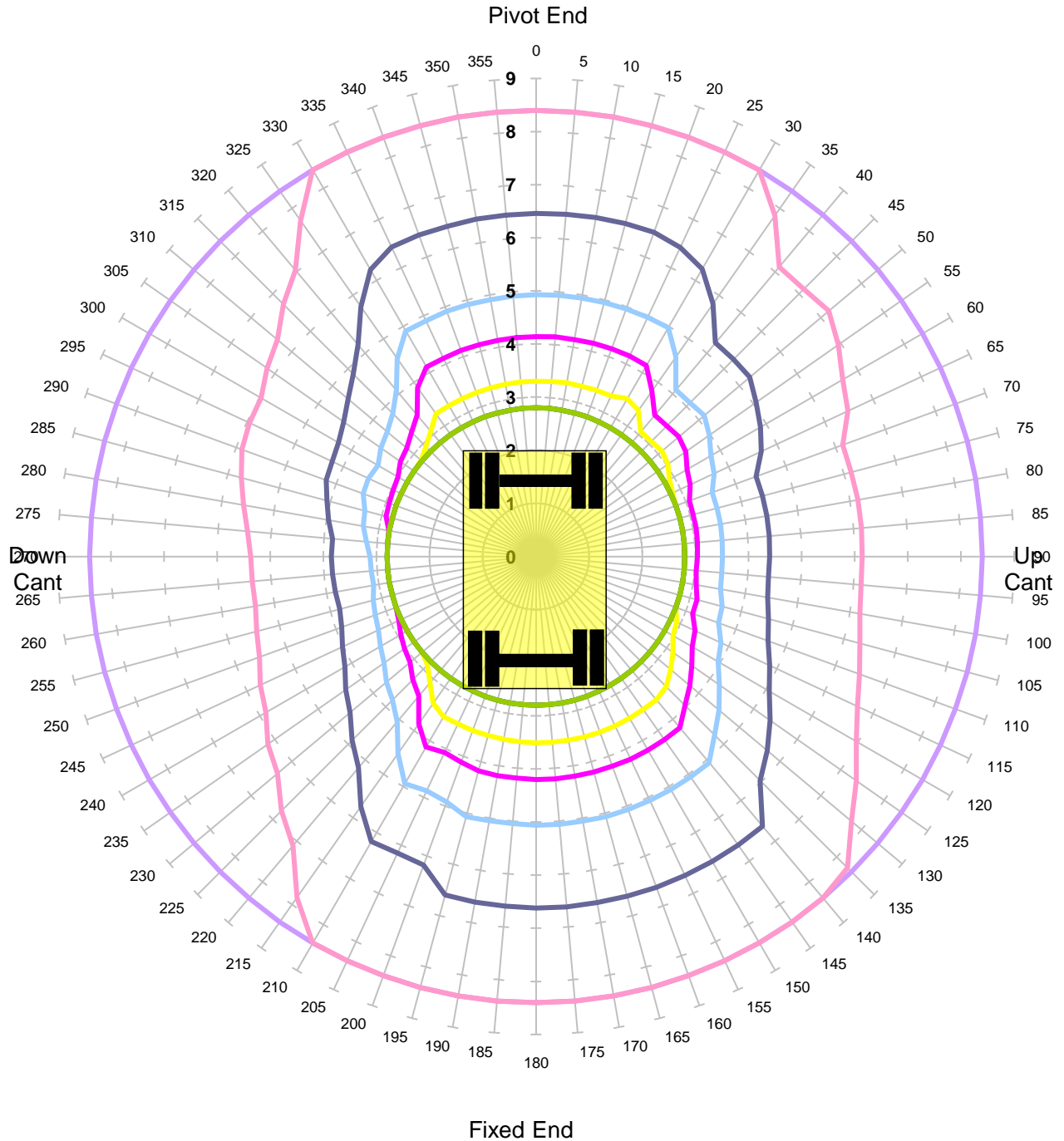

Units in Tonnes

- 1
- 2
- 3
- 4
- 5
- 6
- 7
- 8
- 9
- 10

<b>MACHINE &amp; MODEL:</b>	Komatsu PW160-11	<b>REFERENCE:</b>	3.00m Jib
<b>SERIAL No:</b>	H65234	<b>DATE OF CHART:</b>	12-Oct-2020
<b>EQUIPMENT:</b>	2.00m + 3.47m + 2.50m	<b>SAFETY FACTOR:</b>	59.0%
<b>COMMENT:</b>			

**Komatsu PW160-11**  
**Max Capacity Contours of Radius(m) Plots 2.5m Dipper**  
**Gradient 1 in -25 Height 2m Lift QH**  
**Locked Rail Cant 150mm - Tandem Lift**

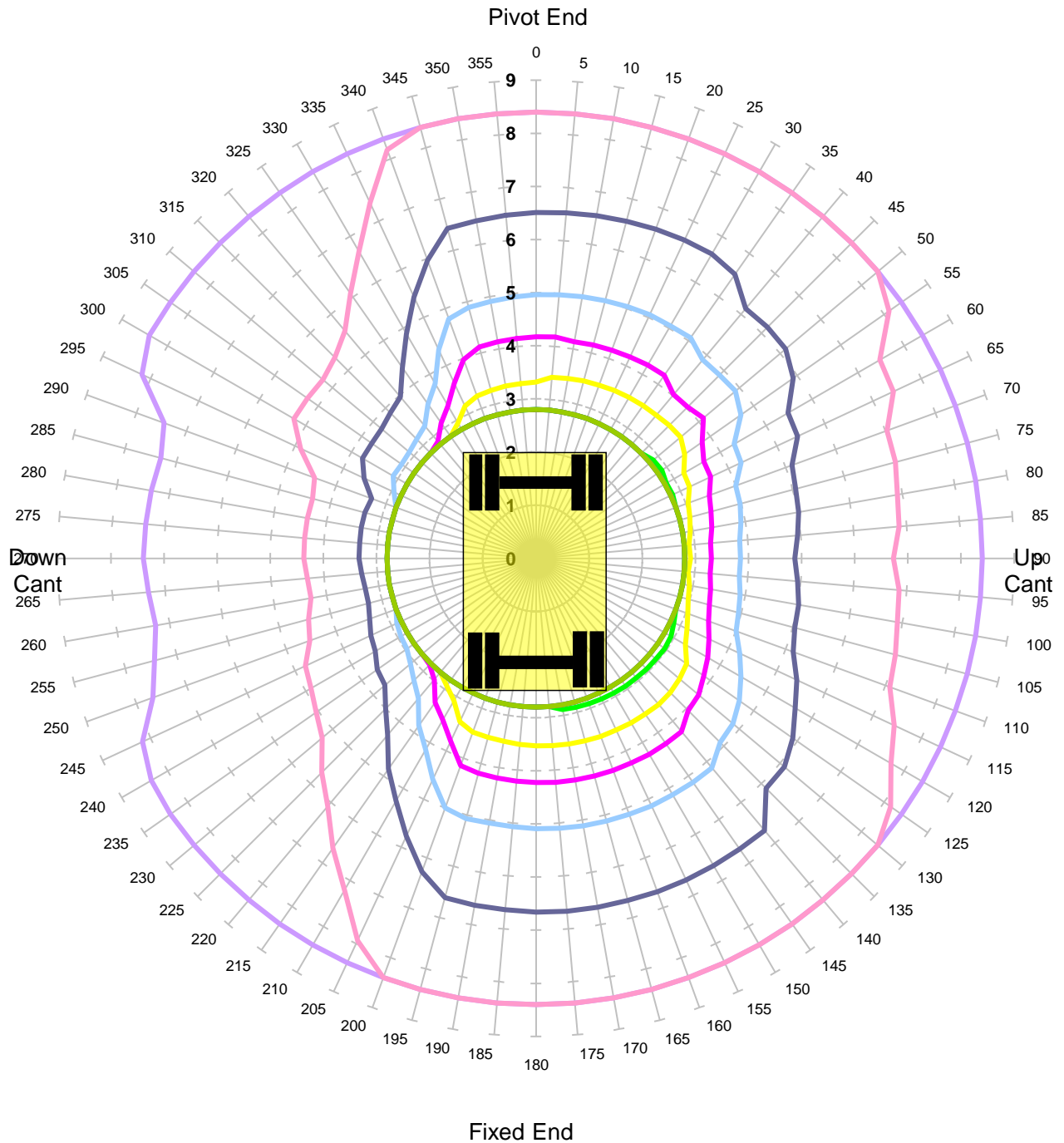

Units in Tonnes

- 1
- 2
- 3
- 4
- 5
- 6
- 7
- 8
- 9
- 10

<b>MACHINE &amp; MODEL:</b>	Komatsu PW160-11	<b>REFERENCE:</b>	3.00m Jib
<b>SERIAL No:</b>	H65234	<b>DATE OF CHART:</b>	12-Oct-2020
<b>EQUIPMENT:</b>	2.00m + 3.47m + 2.50m	<b>SAFETY FACTOR:</b>	59.0%
<b>COMMENT:</b>			

**Komatsu PW160-11**  
**Max Capacity Contours of Radius(m) Plots 2.5m Dipper**  
**Level Ground Height 2m Lift QH**  
**Unlocked Road - Tandem Lift**

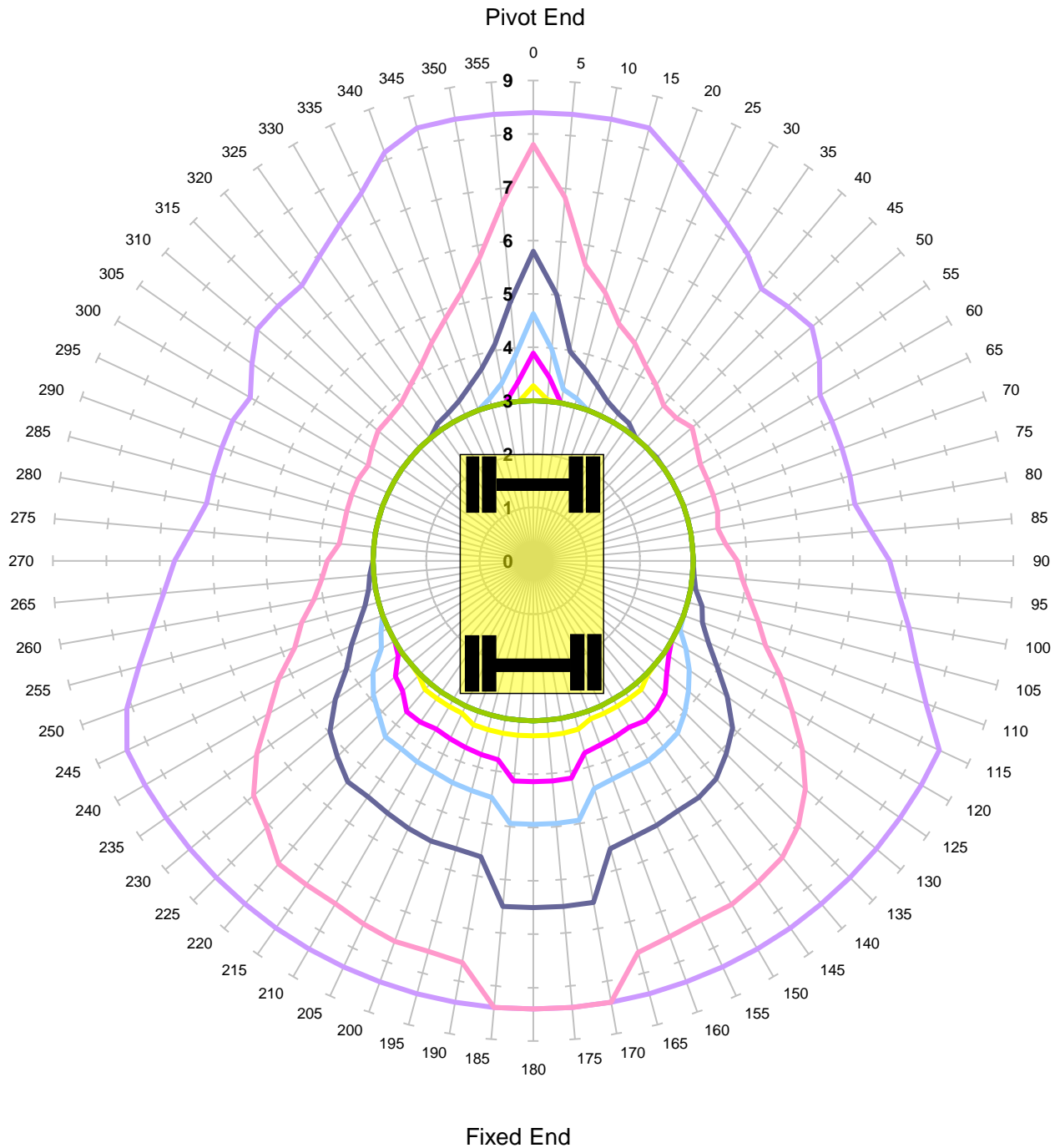

Units in Tonnes

- 1
- 2
- 3
- 4
- 5
- 6
- 7
- 8
- 9
- 10

<b>MACHINE &amp; MODEL:</b>	Komatsu PW160-11	<b>REFERENCE:</b>	3.00m Jib
<b>SERIAL No:</b>	H65234	<b>DATE OF CHART:</b>	12-Oct-2020
<b>EQUIPMENT:</b>	2.00m + 3.47m + 2.50m	<b>SAFETY FACTOR:</b>	47.0%
<b>COMMENT:</b>			

**Komatsu PW160-11**  
**Max Capacity Contours of Radius(m) Plots 2.5m Dipper**  
**Level Ground Height 2m Lift QH**  
**Locked Road - Tandem Lift**

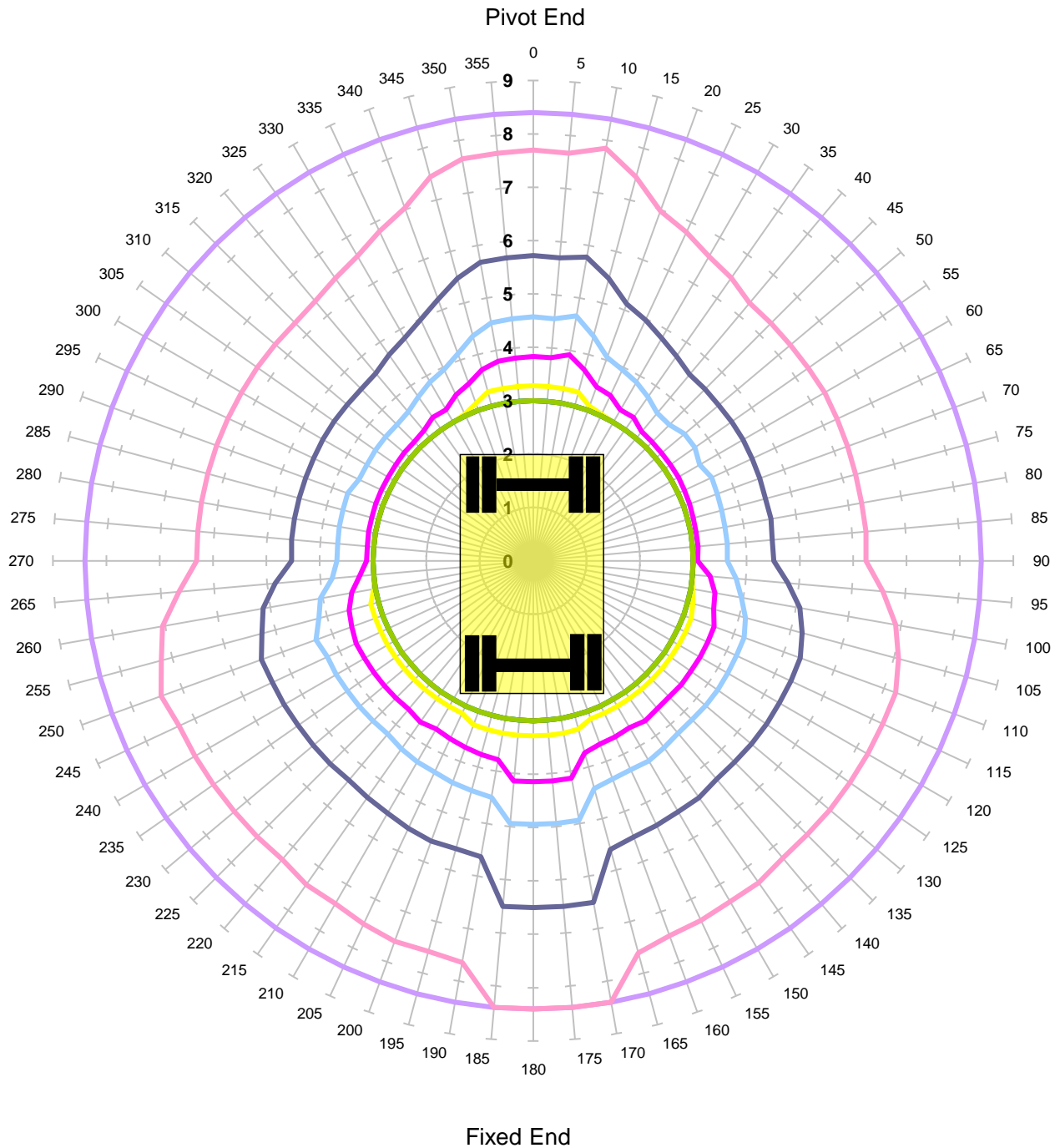

Units in Tonnes

- 1
- 2
- 3
- 4
- 5
- 6
- 7
- 8
- 9
- 10

<b>MACHINE &amp; MODEL:</b>	Komatsu PW160-11	<b>REFERENCE:</b>	3.00m Jib
<b>SERIAL No:</b>	H65234	<b>DATE OF CHART:</b>	12-Oct-2020
<b>EQUIPMENT:</b>	2.00m + 3.47m + 2.50m	<b>SAFETY FACTOR:</b>	47.0%
<b>COMMENT:</b>			

**Komatsu PW160-11**  
**Max Capacity Contours of Radius(m) Plots 2.5m Dipper 3.0m Jib**  
**Gradient 1 in -25 Height 2m Lift JIBLP**  
**Unlocked Rail Cant -150mm**

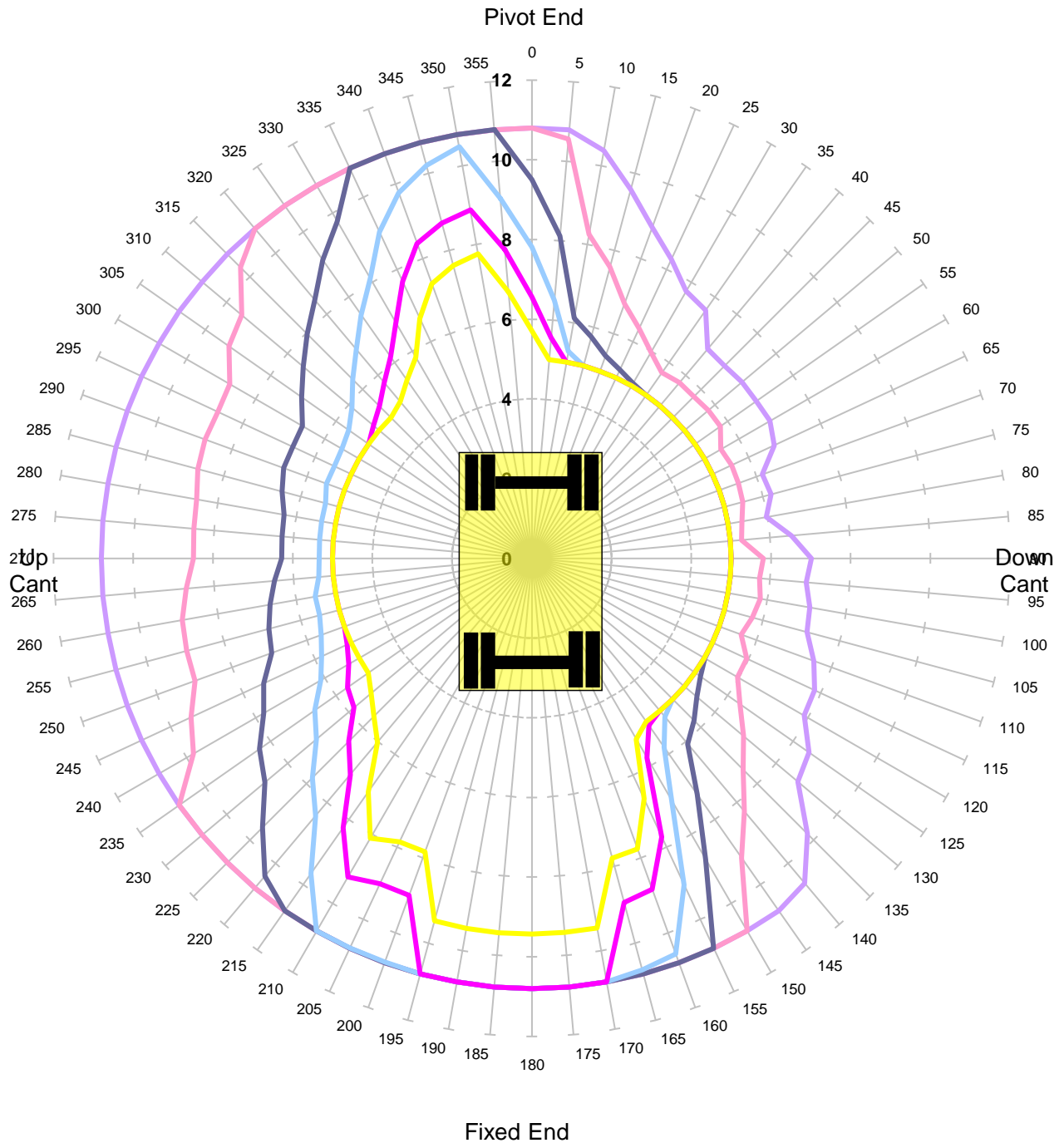

Units in Tonnes

- 0.5
- 1
- 1.5
- 2
- 2.5
- 3

<b>MACHINE &amp; MODEL:</b>	Komatsu PW160-11	<b>REFERENCE:</b>	3.00m Jib
<b>SERIAL No:</b>	H65234	<b>DATE OF CHART:</b>	12-Oct-2020
<b>EQUIPMENT:</b>	2.00m + 3.47m + 2.50m	<b>SAFETY FACTOR:</b>	67.0%
<b>COMMENT:</b>			

**Komatsu PW160-11**  
**Max Capacity Contours of Radius(m) Plots 2.5m Dipper 3.0m Jib**  
**Gradient 1 in -25 Height 2m Lift JIBLP**  
**Unlocked Rail Cant -50mm**

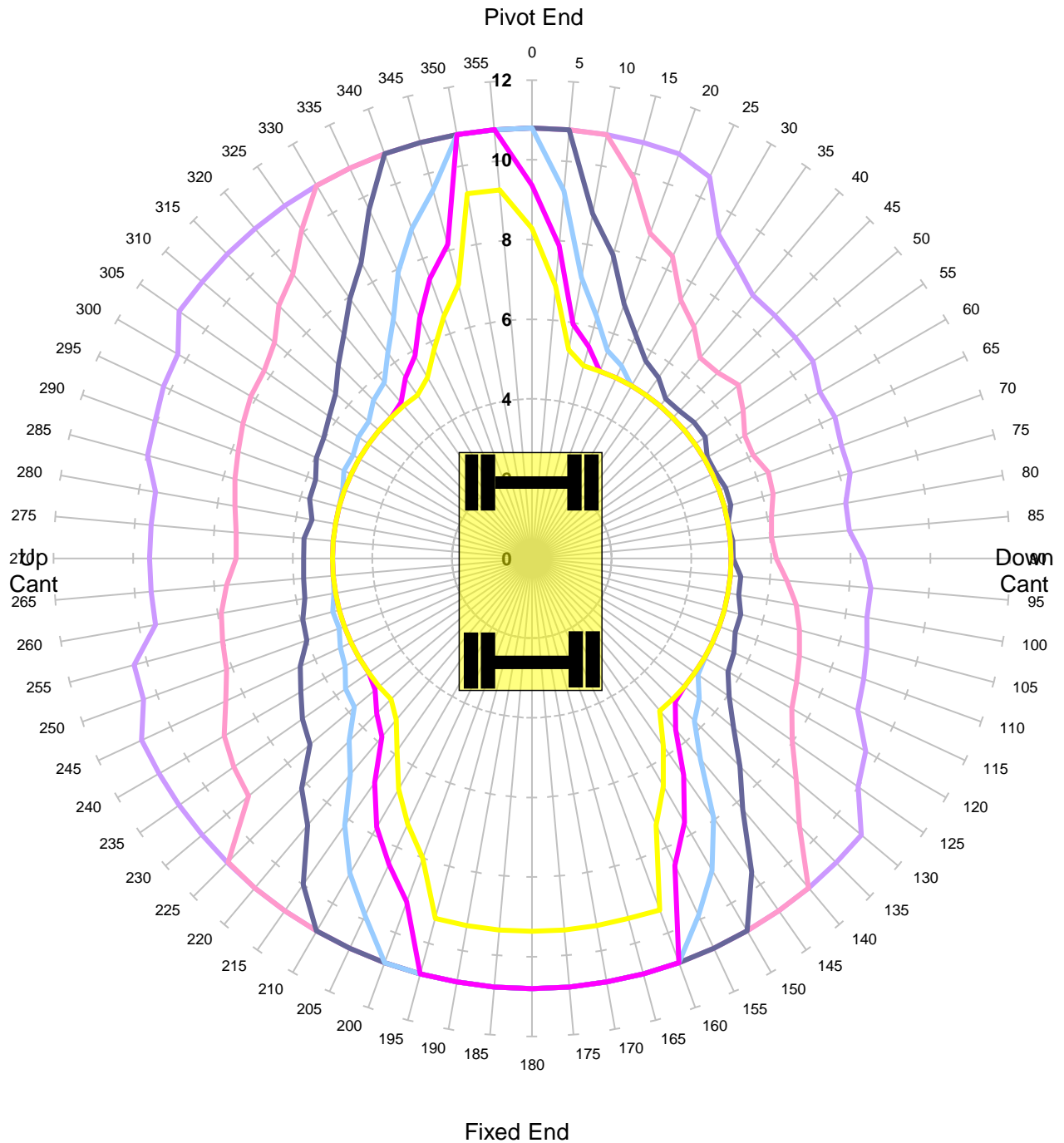

Units in Tonnes

- 0.5
- 1
- 1.5
- 2
- 2.5
- 3

<b>MACHINE &amp; MODEL:</b>	Komatsu PW160-11	<b>REFERENCE:</b>	3.00m Jib
<b>SERIAL No:</b>	H65234	<b>DATE OF CHART:</b>	12-Oct-2020
<b>EQUIPMENT:</b>	2.00m + 3.47m + 2.50m	<b>SAFETY FACTOR:</b>	67.0%
<b>COMMENT:</b>			



**Komatsu PW160-11**  
**Max Capacity Contours of Radius(m) Plots 2.5m Dipper 3.0m Jib**  
**Gradient 1 in -25 Height 2m Lift JIBLP**  
**Unlocked Rail Cant 50mm**

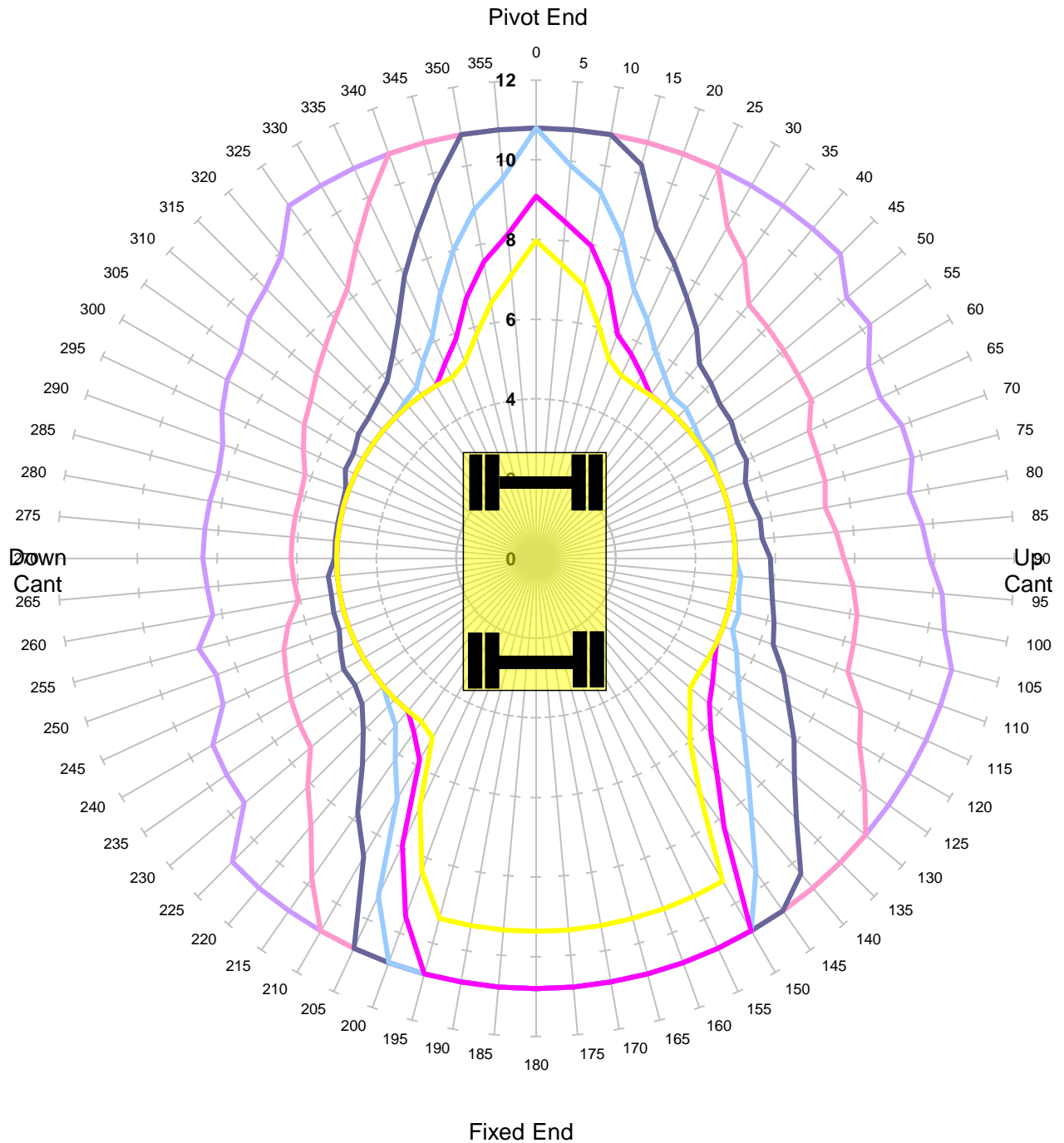

Units in Tonnes

— 0.5 — 1 — 1.5 — 2 — 2.5 — 3

<b>MACHINE &amp; MODEL:</b>	Komatsu PW160-11	<b>REFERENCE:</b>	3.00m Jib
<b>SERIAL No:</b>	H65234	<b>DATE OF CHART:</b>	12-Oct-2020
<b>EQUIPMENT:</b>	2.00m + 3.47m + 2.50m	<b>SAFETY FACTOR:</b>	67.0%
<b>COMMENT:</b>			

**Komatsu PW160-11**  
**Max Capacity Contours of Radius(m) Plots 2.5m Dipper 3.0m Jib**  
**Gradient 1 in -25 Height 2m Lift JIBLP**  
**Unlocked Rail Cant 150mm**

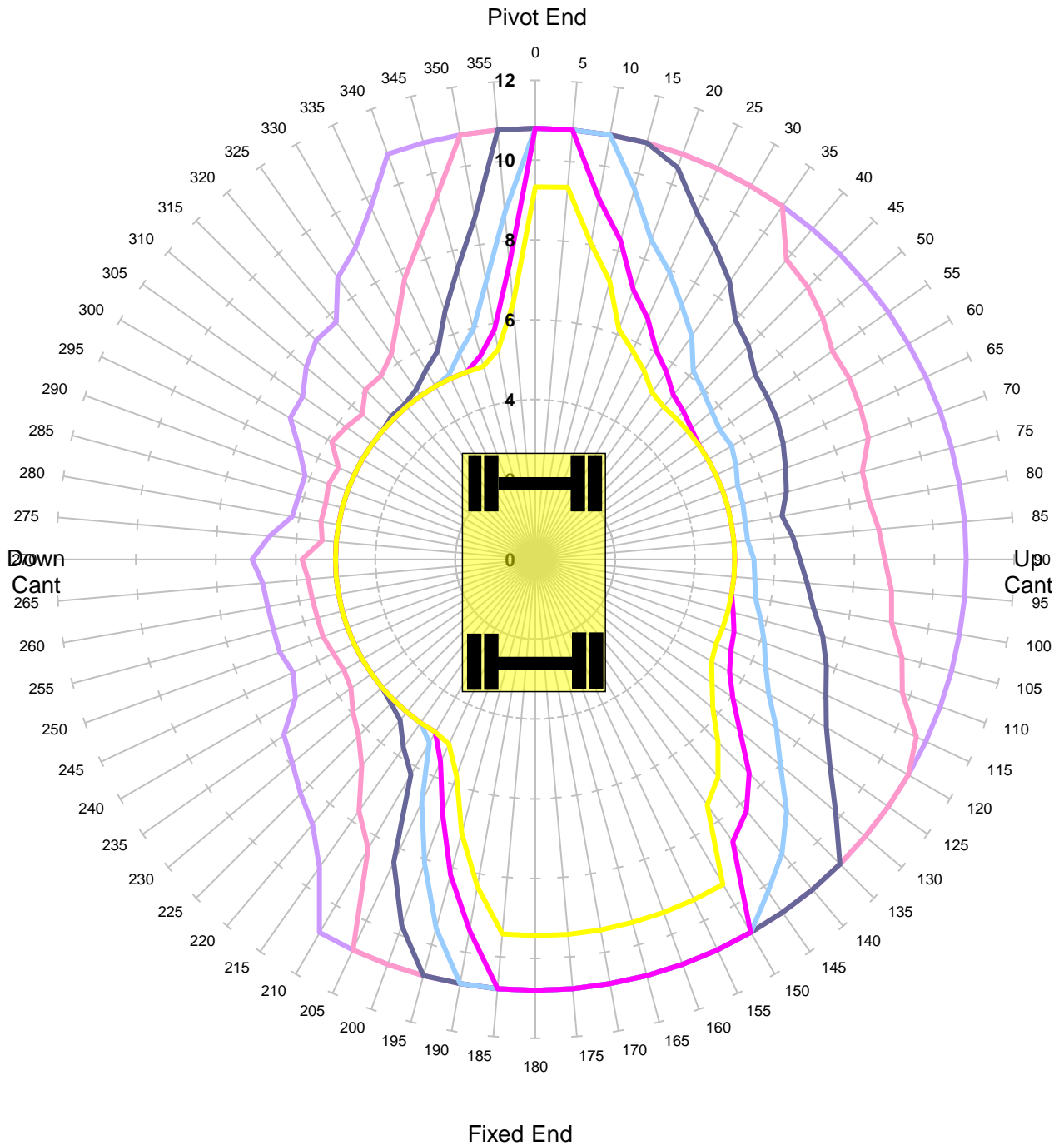

Units in Tonnes

— 0.5 — 1 — 1.5 — 2 — 2.5 — 3

<b>MACHINE &amp; MODEL:</b>	Komatsu PW160-11	<b>REFERENCE:</b>	3.00m Jib
<b>SERIAL No:</b>	H65234	<b>DATE OF CHART:</b>	12-Oct-2020
<b>EQUIPMENT:</b>	2.00m + 3.47m + 2.50m	<b>SAFETY FACTOR:</b>	67.0%
<b>COMMENT:</b>			

**Komatsu PW160-11**  
**Max Capacity Contours of Radius(m) Plots 2.5m Dipper 3.0m Jib**  
**Gradient 1 in -25 Height 2m Lift JIBLP**  
**Locked Rail Cant -150mm**

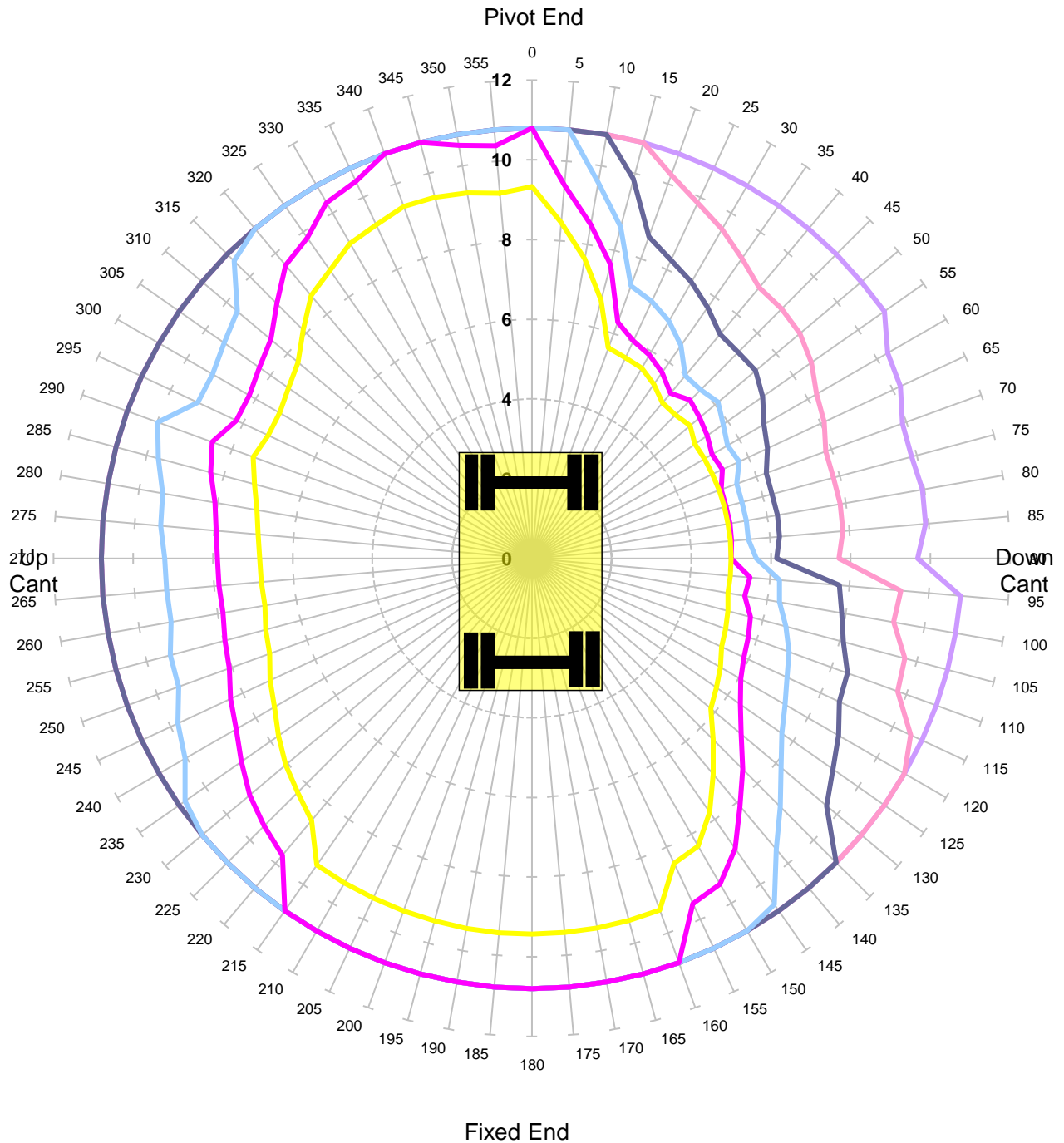

Units in Tonnes

- 0.5
- 1
- 1.5
- 2
- 2.5
- 3

<b>MACHINE &amp; MODEL:</b>	Komatsu PW160-11	<b>REFERENCE:</b>	3.00m Jib
<b>SERIAL No:</b>	H65234	<b>DATE OF CHART:</b>	12-Oct-2020
<b>EQUIPMENT:</b>	2.00m + 3.47m + 2.50m	<b>SAFETY FACTOR:</b>	90.0%
<b>COMMENT:</b>			

**Komatsu PW160-11**  
**Max Capacity Contours of Radius(m) Plots 2.5m Dipper 3.0m Jib**  
**Gradient 1 in -25 Height 2m Lift JIBLP**  
**Locked Rail Cant -50mm**

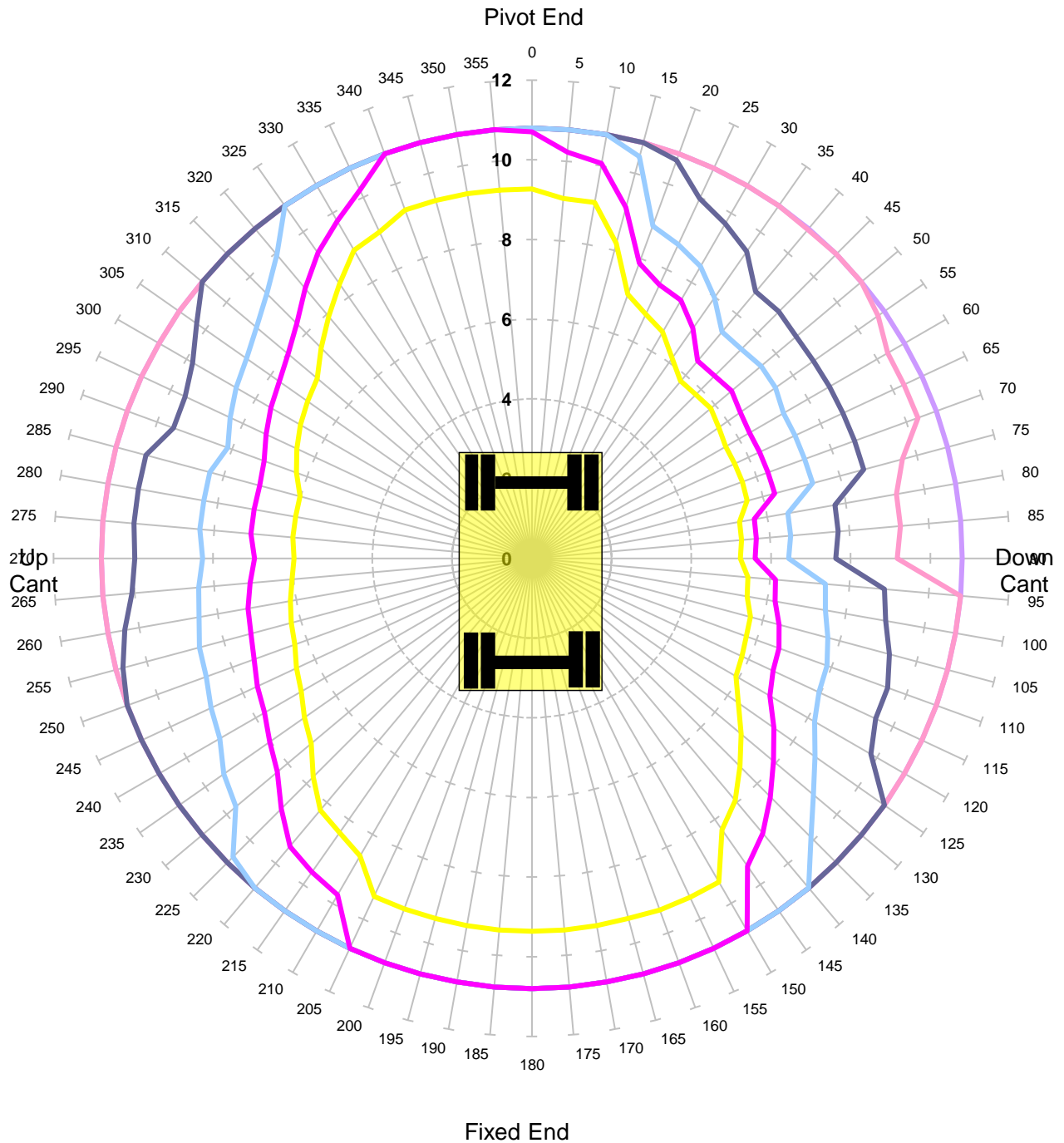

Units in Tonnes

— 0.5 — 1 — 1.5 — 2 — 2.5 — 3

<b>MACHINE &amp; MODEL:</b>	Komatsu PW160-11	<b>REFERENCE:</b>	3.00m Jib
<b>SERIAL No:</b>	H65234	<b>DATE OF CHART:</b>	12-Oct-2020
<b>EQUIPMENT:</b>	2.00m + 3.47m + 2.50m	<b>SAFETY FACTOR:</b>	90.0%
<b>COMMENT:</b>			

**Komatsu PW160-11**  
**Max Capacity Contours of Radius(m) Plots 2.5m Dipper 3.0m Jib**  
**Gradient 1 in -25 Height 2m Lift JIBLP**  
**Locked Rail Cant 50mm**

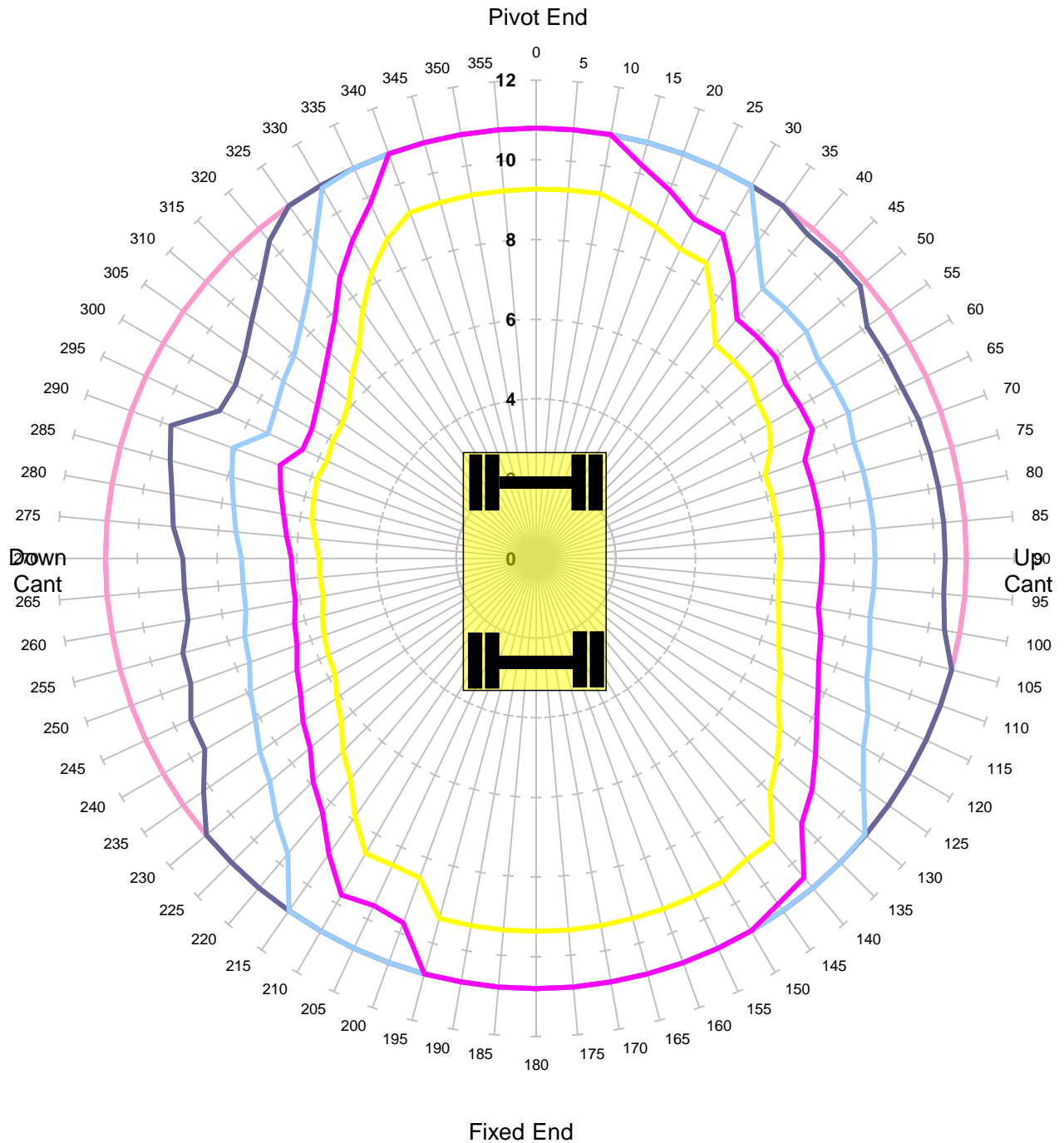

Units in Tonnes

— 0.5 — 1 — 1.5 — 2 — 2.5 — 3

<b>MACHINE &amp; MODEL:</b>	Komatsu PW160-11	<b>REFERENCE:</b>	3.00m Jib
<b>SERIAL No:</b>	H65234	<b>DATE OF CHART:</b>	12-Oct-2020
<b>EQUIPMENT:</b>	2.00m + 3.47m + 2.50m	<b>SAFETY FACTOR:</b>	90.0%
<b>COMMENT:</b>			

**Komatsu PW160-11**  
**Max Capacity Contours of Radius(m) Plots 2.5m Dipper 3.0m Jib**  
**Gradient 1 in -25 Height 2m Lift JIBLP**  
**Locked Rail Cant 150mm**

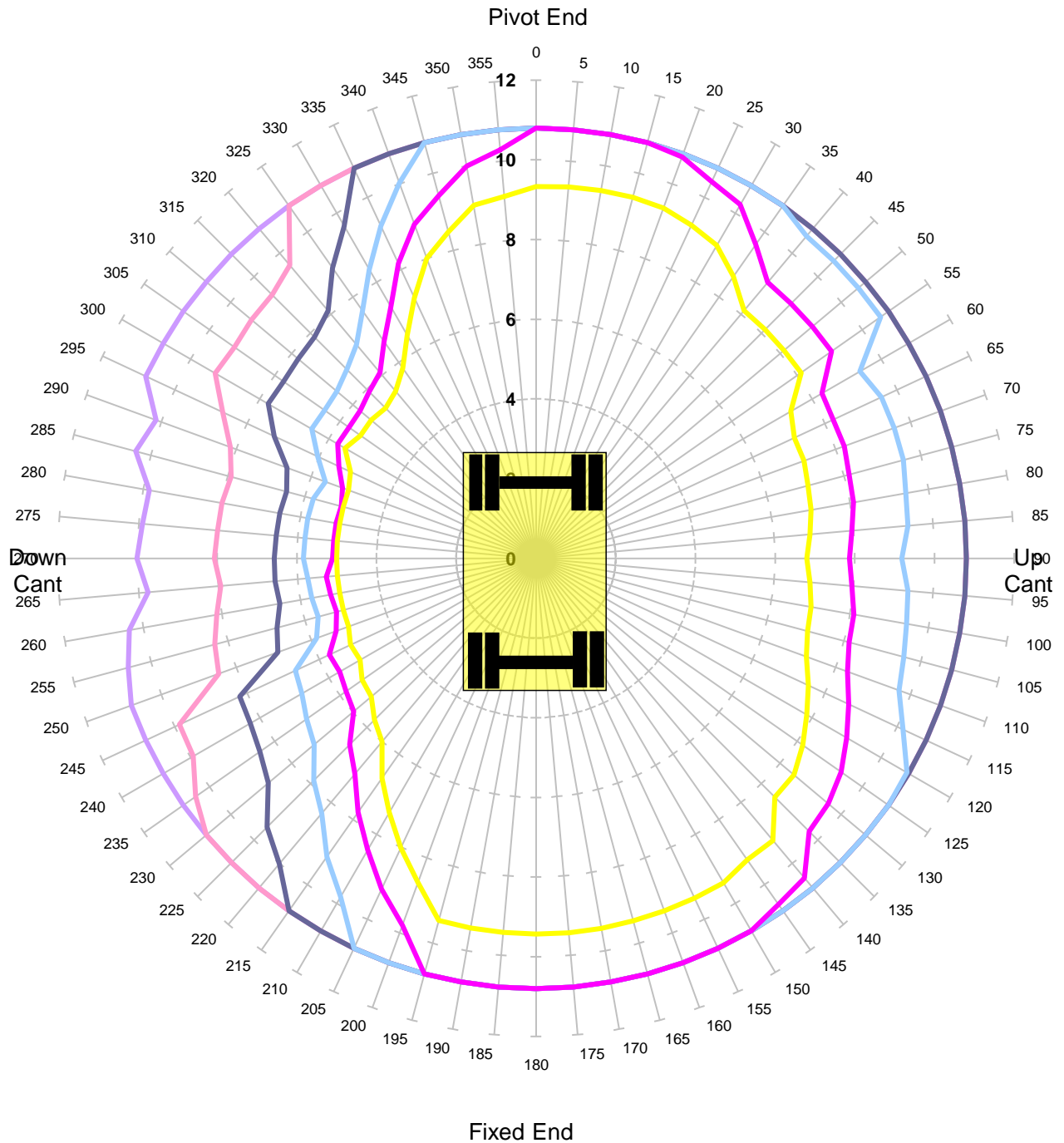

Units in Tonnes

— 0.5 — 1 — 1.5 — 2 — 2.5 — 3

<b>MACHINE &amp; MODEL:</b>	Komatsu PW160-11	<b>REFERENCE:</b>	3.00m Jib
<b>SERIAL No:</b>	H65234	<b>DATE OF CHART:</b>	12-Oct-2020
<b>EQUIPMENT:</b>	2.00m + 3.47m + 2.50m	<b>SAFETY FACTOR:</b>	90.0%
<b>COMMENT:</b>			



**Komatsu PW160-11**  
**Max Capacity Contours of Radius(m) Plots 2.5m Dipper 3.0m Jib**  
**Level Ground Height 2m Lift JIBLP**  
**Unlocked Road**

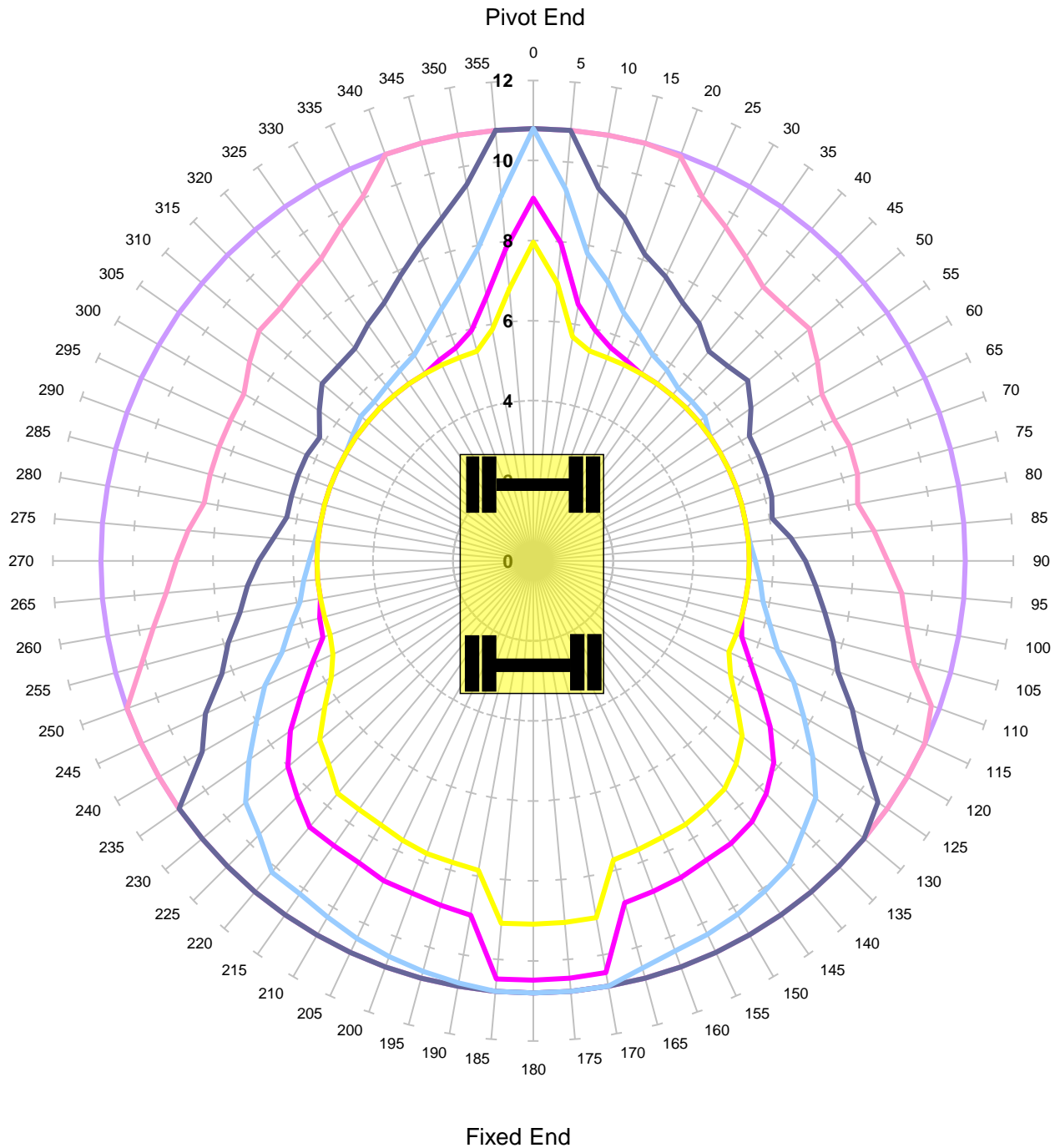

Units in Tonnes

— 0.5 — 1 — 1.5 — 2 — 2.5 — 3

<b>MACHINE &amp; MODEL:</b>	Komatsu PW160-11	<b>REFERENCE:</b>	3.00m Jib
<b>SERIAL No:</b>	H65234	<b>DATE OF CHART:</b>	12-Oct-2020
<b>EQUIPMENT:</b>	2.00m + 3.47m + 2.50m	<b>SAFETY FACTOR:</b>	71.0%
<b>COMMENT:</b>			

**Komatsu PW160-11**  
**Max Capacity Contours of Radius(m) Plots 2.5m Dipper 3.0m Jib**  
**Level Ground Height 2m Lift JIBLP**  
**Locked Road**

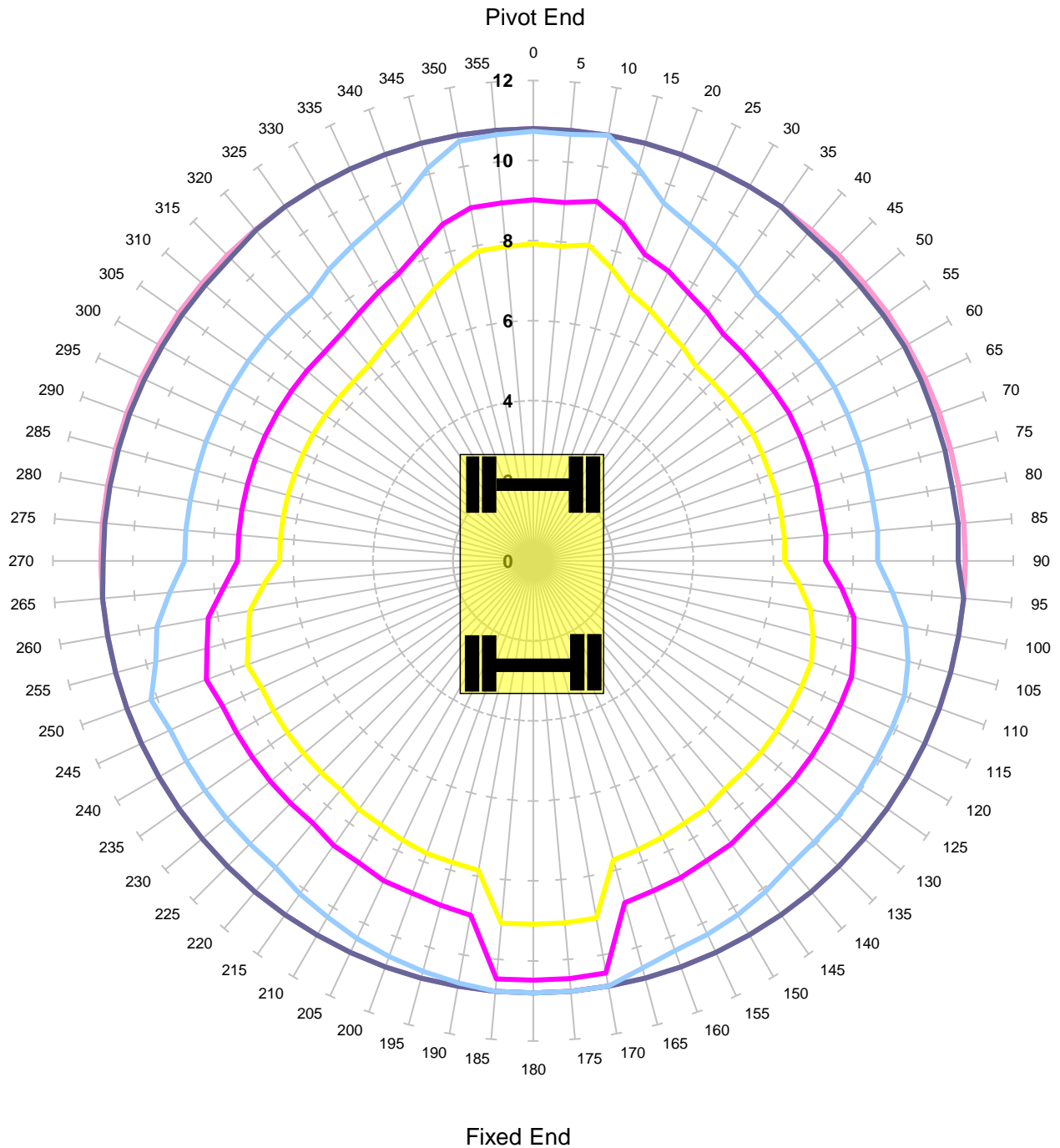

Units in Tonnes

— 0.5 — 1 — 1.5 — 2 — 2.5 — 3

<b>MACHINE &amp; MODEL:</b>	Komatsu PW160-11	<b>REFERENCE:</b>	3.00m Jib
<b>SERIAL No:</b>	H65234	<b>DATE OF CHART:</b>	12-Oct-2020
<b>EQUIPMENT:</b>	2.00m + 3.47m + 2.50m	<b>SAFETY FACTOR:</b>	71.0%
<b>COMMENT:</b>			

# Komatsu PW160-11

**Max Capacity Contours of Radius(m) Plots 2.5m Dipper 3.0m Jib  
Gradient 1 in -25 Height 2m Lift JIBLP**

**Unlocked Rail Cant -150mm - Tandem Lift**

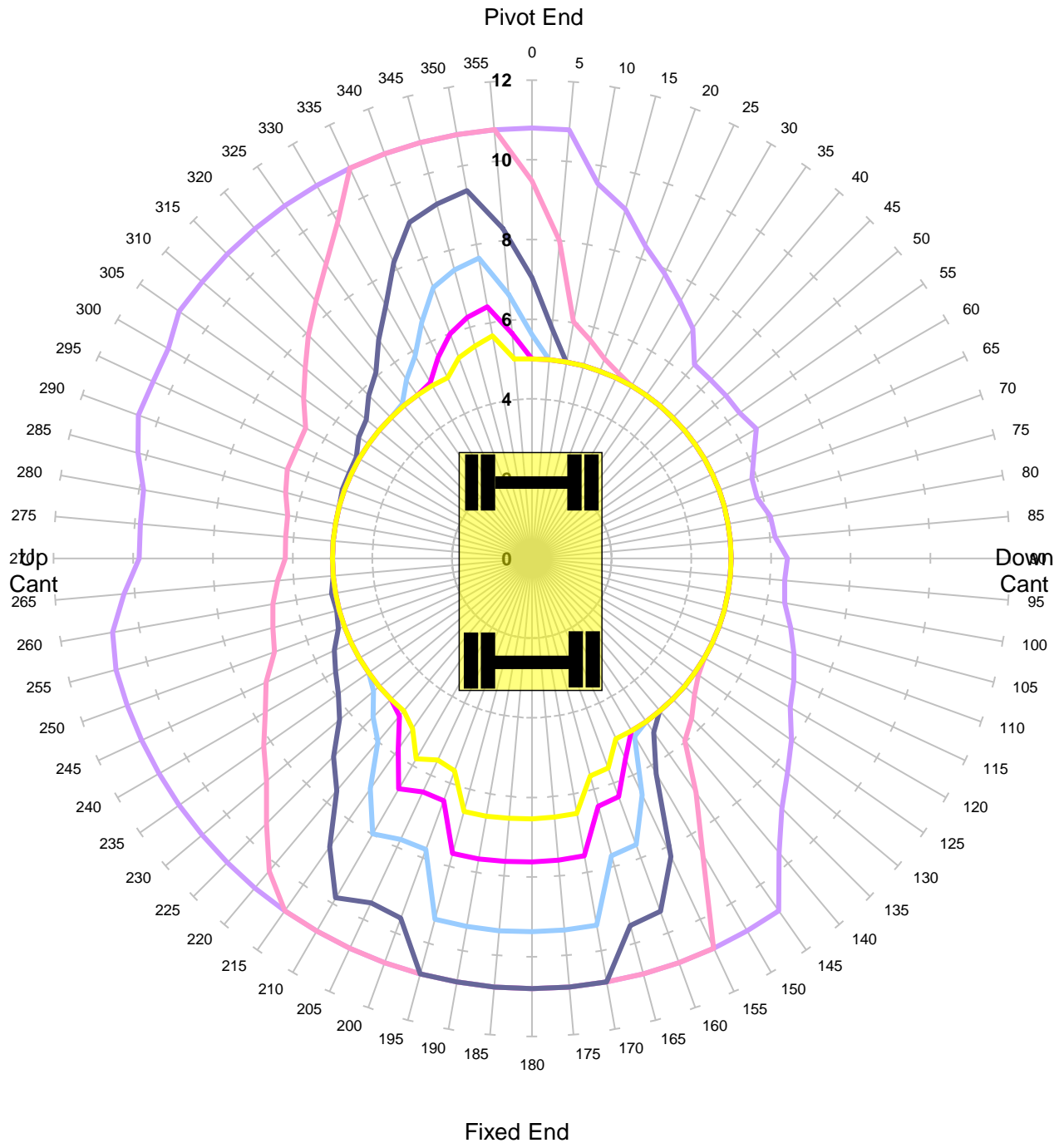

Units in Tonnes

— 0.5   
 — 1   
 — 1.5   
 — 2   
 — 2.5   
 — 3

<b>MACHINE &amp; MODEL:</b>	Komatsu PW160-11	<b>REFERENCE:</b>	3.00m Jib
<b>SERIAL No:</b>	H65234	<b>DATE OF CHART:</b>	12-Oct-2020
<b>EQUIPMENT:</b>	2.00m + 3.47m + 2.50m	<b>SAFETY FACTOR:</b>	44.0%
<b>COMMENT:</b>			

# Komatsu PW160-11

**Max Capacity Contours of Radius(m) Plots 2.5m Dipper 3.0m Jib  
Gradient 1 in -25 Height 2m Lift JIBLP**

**Unlocked Rail Cant -50mm - Tandem Lift**

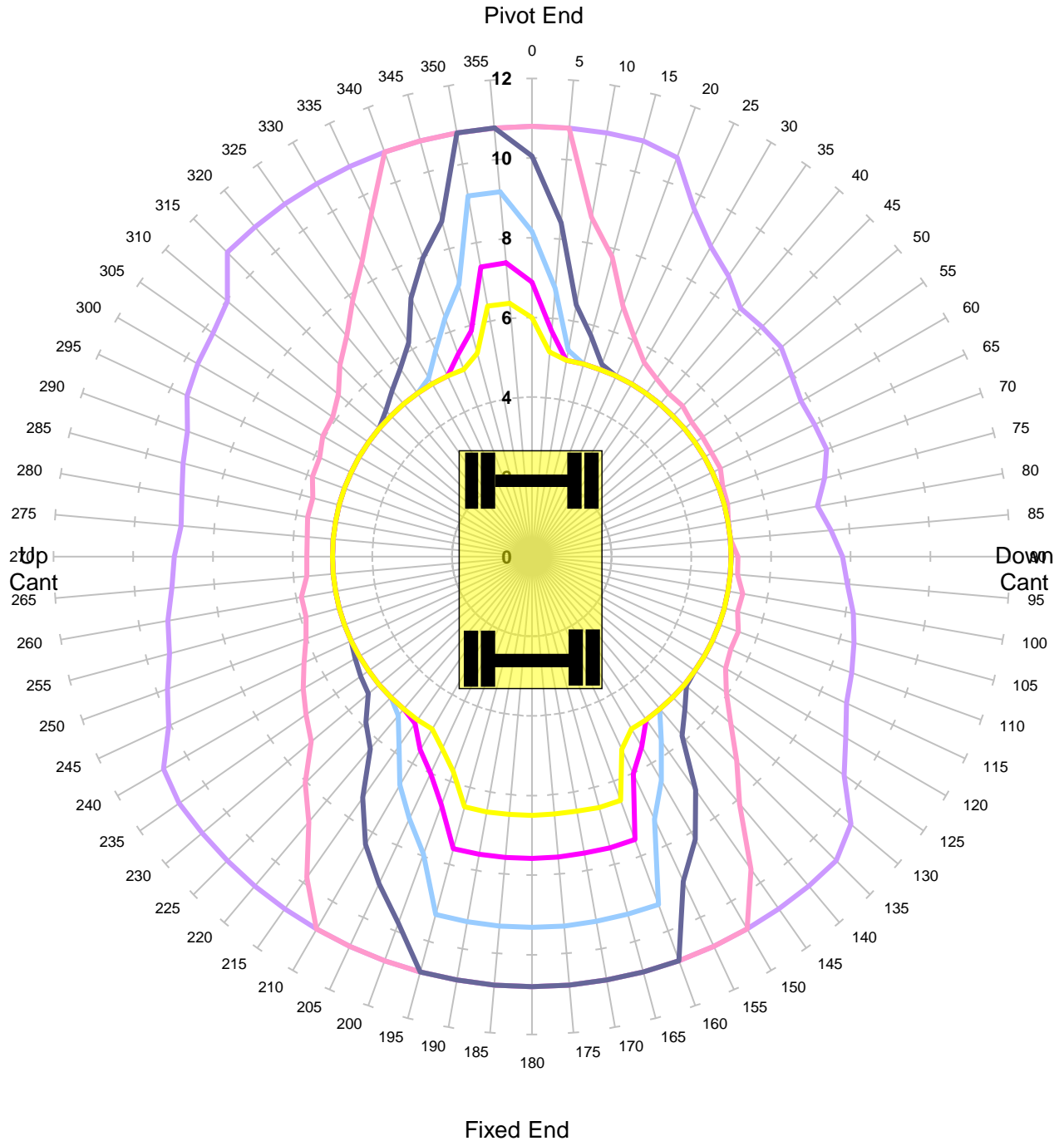

<b>MACHINE &amp; MODEL:</b>	Komatsu PW160-11	<b>REFERENCE:</b>	3.00m Jib
<b>SERIAL No:</b>	H65234	<b>DATE OF CHART:</b>	12-Oct-2020
<b>EQUIPMENT:</b>	2.00m + 3.47m + 2.50m	<b>SAFETY FACTOR:</b>	44.0%
<b>COMMENT:</b>			

# Komatsu PW160-11

**Max Capacity Contours of Radius(m) Plots 2.5m Dipper 3.0m Jib  
Gradient 1 in -25 Height 2m Lift JIBLP**

**Unlocked Rail Cant 50mm - Tandem Lift**

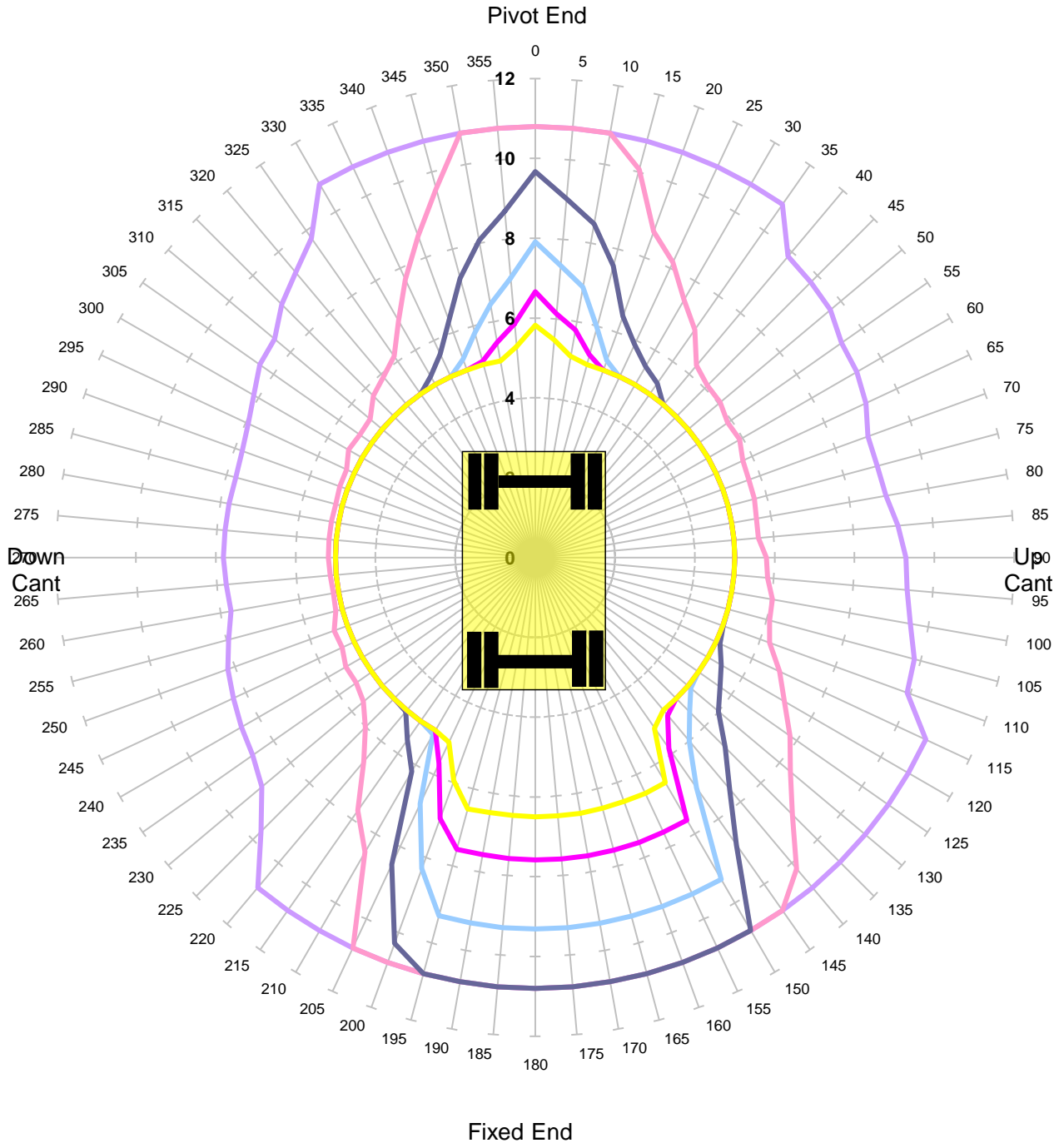

Units in Tonnes

— 0.5   
 — 1   
 — 1.5   
 — 2   
 — 2.5   
 — 3

<b>MACHINE &amp; MODEL:</b>	Komatsu PW160-11	<b>REFERENCE:</b>	3.00m Jib
<b>SERIAL No:</b>	H65234	<b>DATE OF CHART:</b>	12-Oct-2020
<b>EQUIPMENT:</b>	2.00m + 3.47m + 2.50m	<b>SAFETY FACTOR:</b>	44.0%
<b>COMMENT:</b>			

# Komatsu PW160-11

**Max Capacity Contours of Radius(m) Plots 2.5m Dipper 3.0m Jib  
Gradient 1 in -25 Height 2m Lift JIBLP**

**Unlocked Rail Cant 150mm - Tandem Lift**

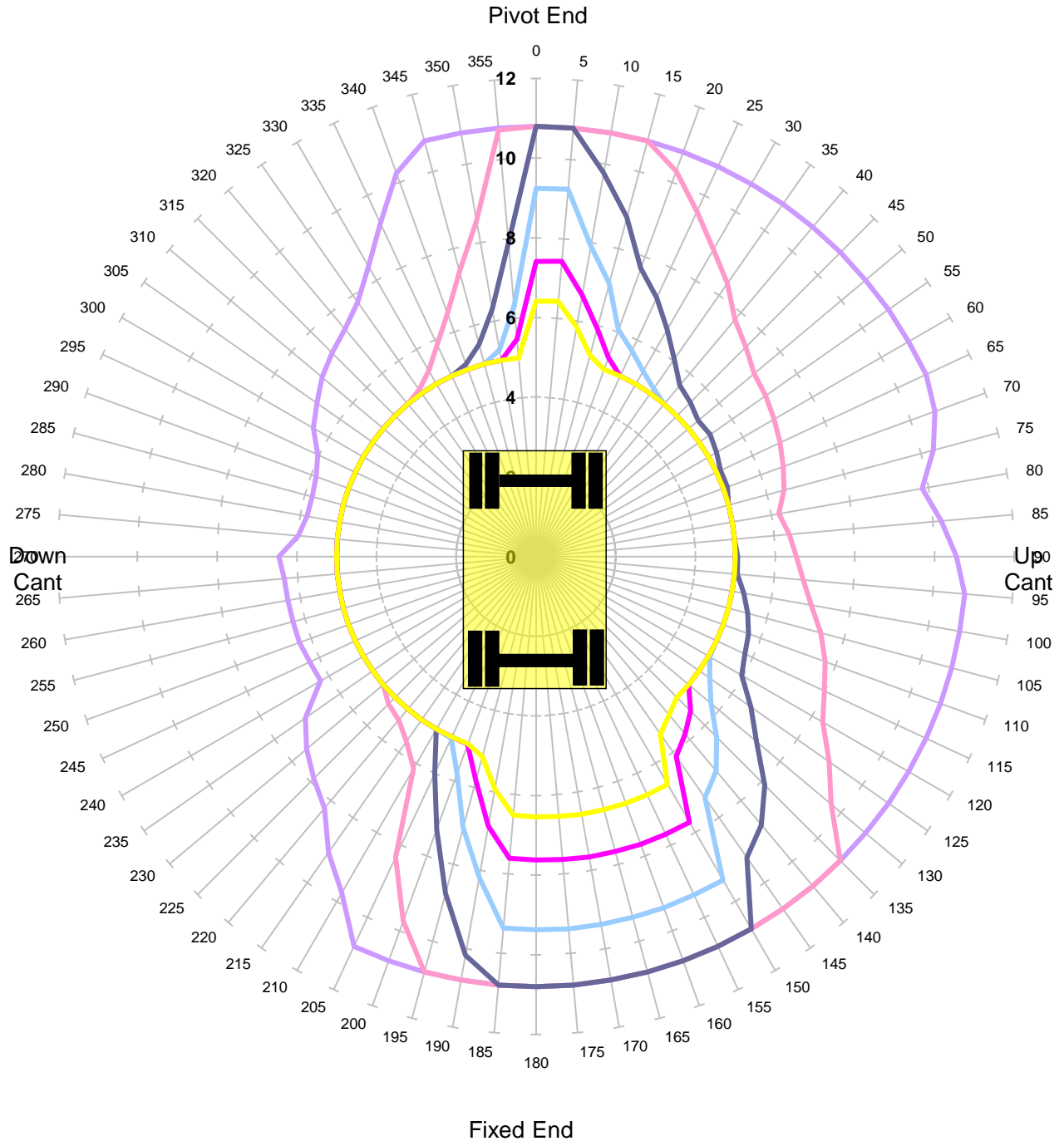

Units in Tonnes

— 0.5   
 — 1   
 — 1.5   
 — 2   
 — 2.5   
 — 3

<b>MACHINE &amp; MODEL:</b>	Komatsu PW160-11	<b>REFERENCE:</b>	3.00m Jib
<b>SERIAL No:</b>	H65234	<b>DATE OF CHART:</b>	12-Oct-2020
<b>EQUIPMENT:</b>	2.00m + 3.47m + 2.50m	<b>SAFETY FACTOR:</b>	44.0%
<b>COMMENT:</b>			



# Komatsu PW160-11

**Max Capacity Contours of Radius(m) Plots 2.5m Dipper 3.0m Jib  
Gradient 1 in -25 Height 2m Lift JIBLP**

**Locked Rail Cant -150mm - Tandem Lift**

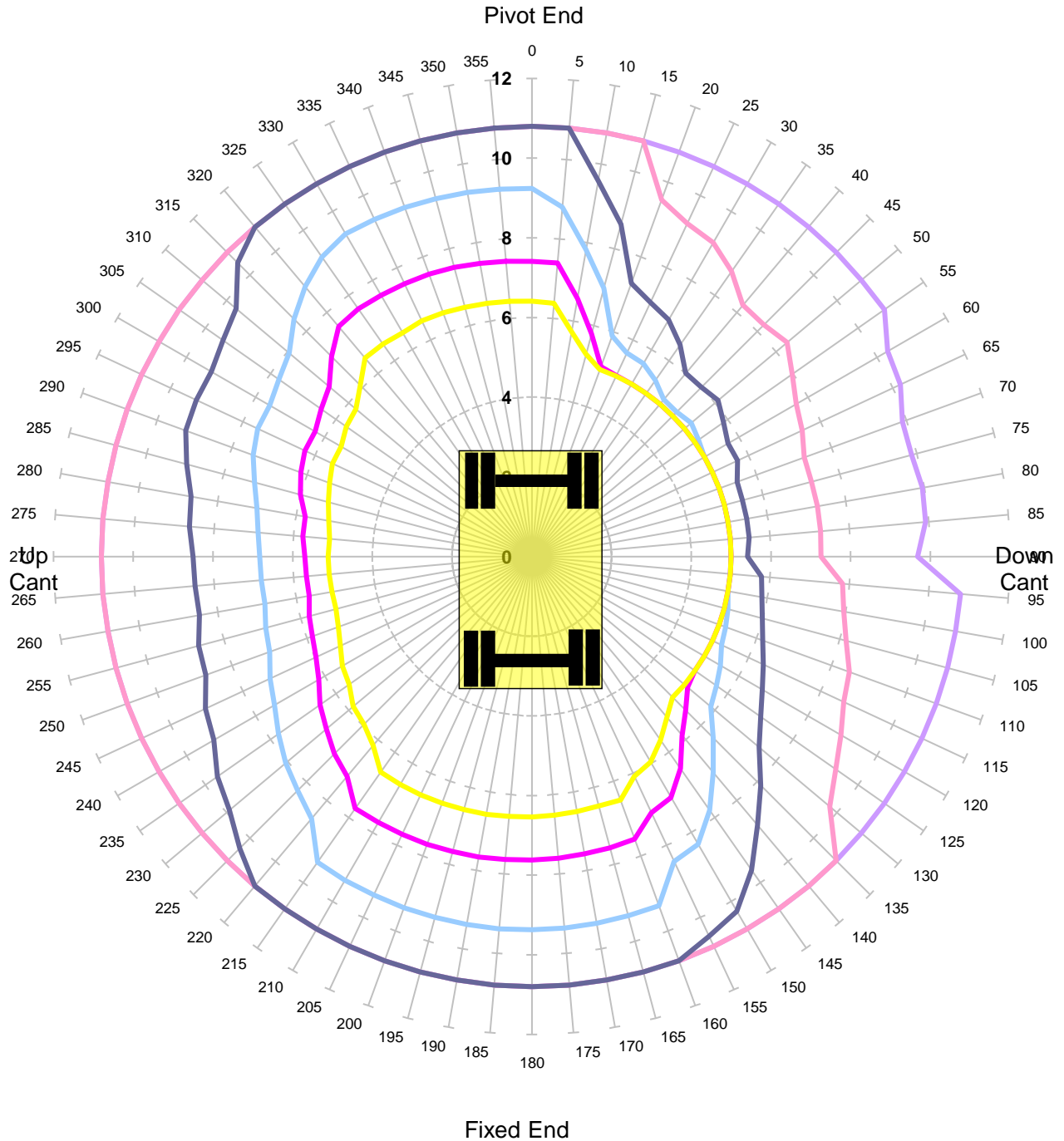

Units in Tonnes

— 0.5   
 — 1   
 — 1.5   
 — 2   
 — 2.5   
 — 3

<b>MACHINE &amp; MODEL:</b>	Komatsu PW160-11	<b>REFERENCE:</b>	3.00m Jib
<b>SERIAL No:</b>	H65234	<b>DATE OF CHART:</b>	12-Oct-2020
<b>EQUIPMENT:</b>	2.00m + 3.47m + 2.50m	<b>SAFETY FACTOR:</b>	59.0%
<b>COMMENT:</b>			

# Komatsu PW160-11

**Max Capacity Contours of Radius(m) Plots 2.5m Dipper 3.0m Jib**  
**Gradient 1 in -25 Height 2m Lift JIBLP**  
**Locked Rail Cant -50mm - Tandem Lift**

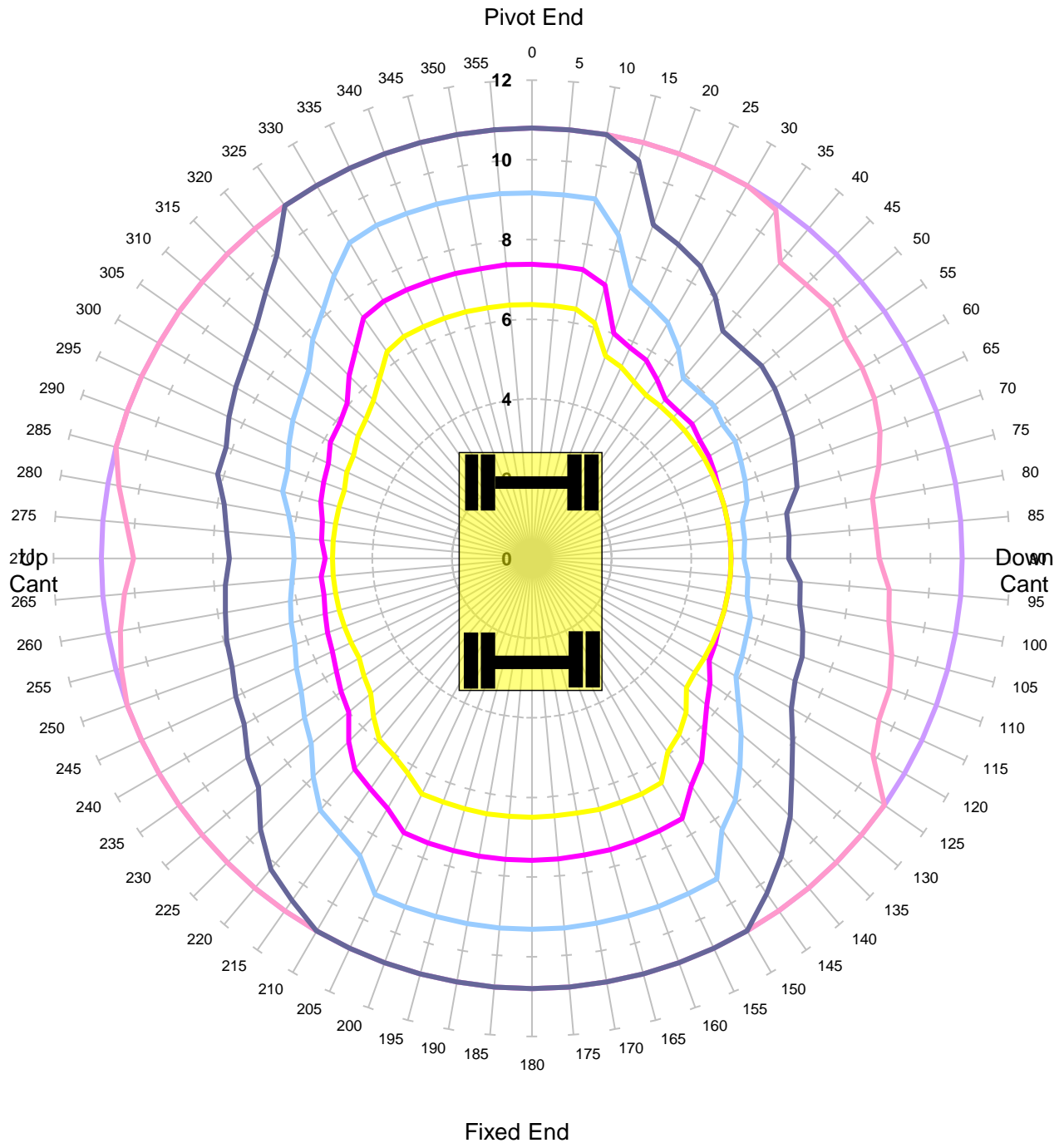

Units in Tonnes

— 0.5   
 — 1   
 — 1.5   
 — 2   
 — 2.5   
 — 3

<b>MACHINE &amp; MODEL:</b>	Komatsu PW160-11	<b>REFERENCE:</b>	3.00m Jib
<b>SERIAL No:</b>	H65234	<b>DATE OF CHART:</b>	12-Oct-2020
<b>EQUIPMENT:</b>	2.00m + 3.47m + 2.50m	<b>SAFETY FACTOR:</b>	59.0%
<b>COMMENT:</b>			

## Komatsu PW160-11

**Max Capacity Contours of Radius(m) Plots 2.5m Dipper 3.0m Jib**  
**Gradient 1 in -25 Height 2m Lift JIBLP**  
**Locked Rail Cant 50mm - Tandem Lift**

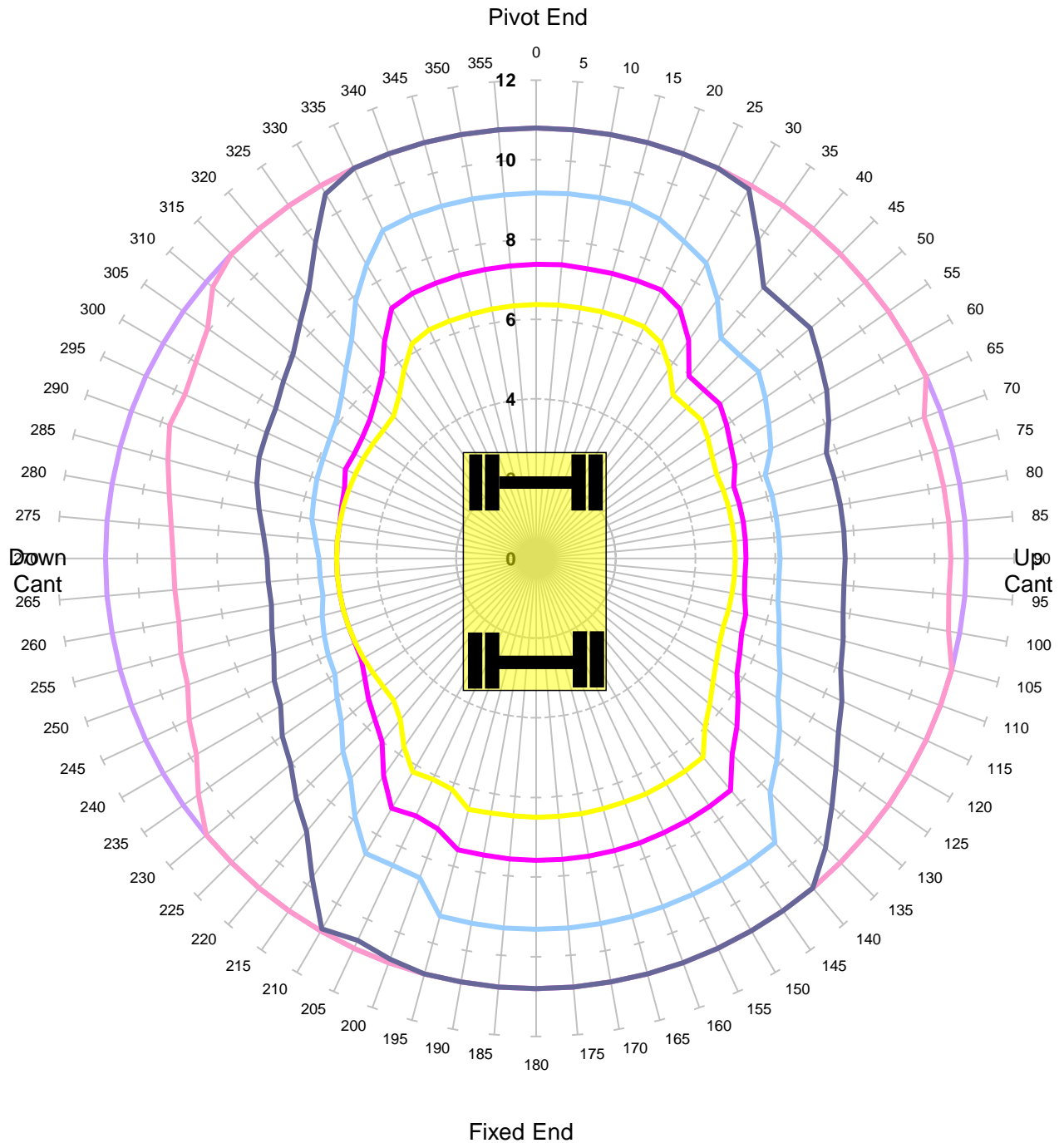

Units in Tonnes

— 0.5   
 — 1   
 — 1.5   
 — 2   
 — 2.5   
 — 3

<b>MACHINE &amp; MODEL:</b>	Komatsu PW160-11	<b>REFERENCE:</b>	3.00m Jib
<b>SERIAL No:</b>	H65234	<b>DATE OF CHART:</b>	12-Oct-2020
<b>EQUIPMENT:</b>	2.00m + 3.47m + 2.50m	<b>SAFETY FACTOR:</b>	59.0%
<b>COMMENT:</b>			

# Komatsu PW160-11

**Max Capacity Contours of Radius(m) Plots 2.5m Dipper 3.0m Jib**  
**Gradient 1 in -25 Height 2m Lift JIBLP**  
**Locked Rail Cant 150mm - Tandem Lift**

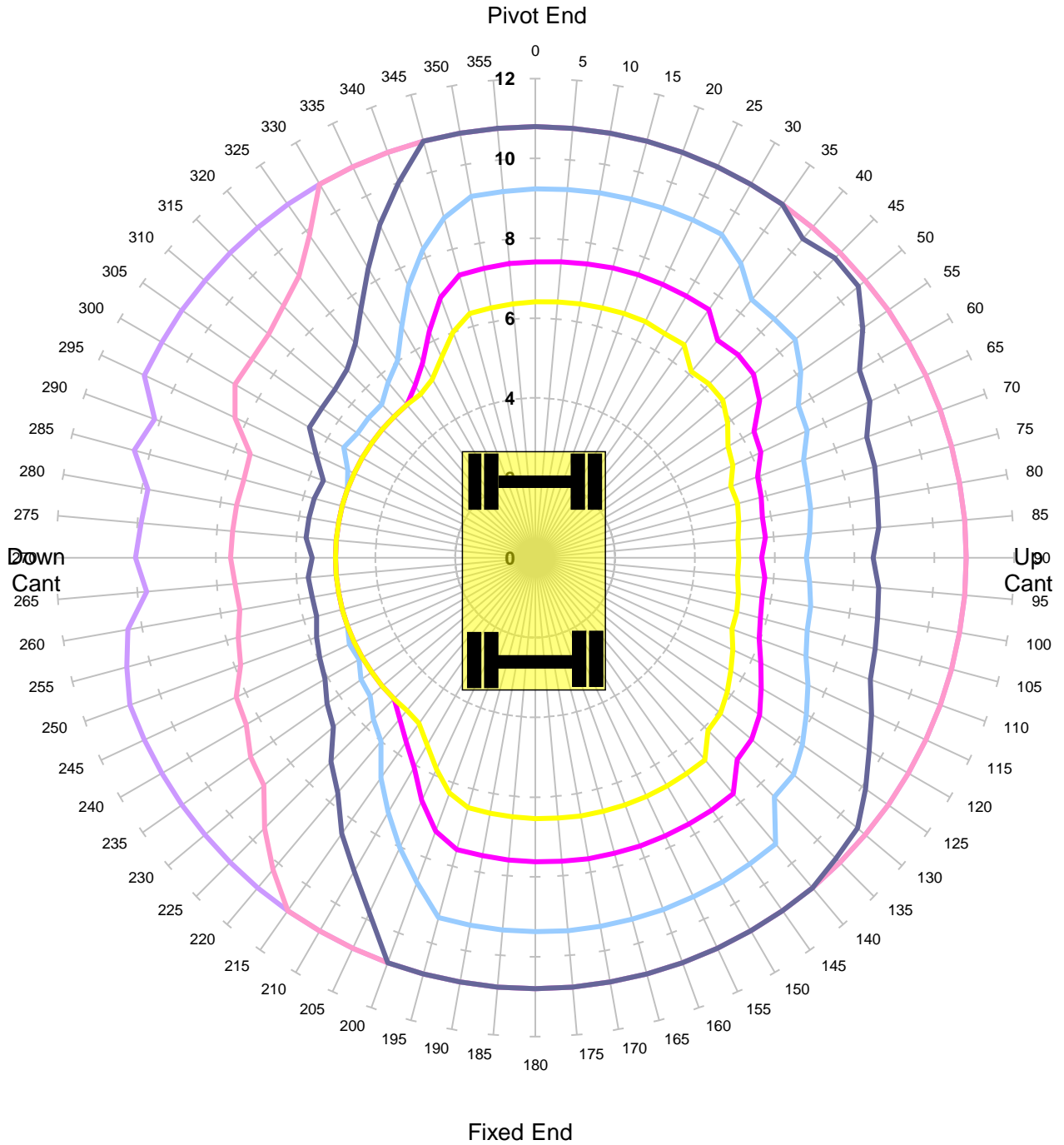

Units in Tonnes

— 0.5   
 — 1   
 — 1.5   
 — 2   
 — 2.5   
 — 3

<b>MACHINE &amp; MODEL:</b>	Komatsu PW160-11	<b>REFERENCE:</b>	3.00m Jib
<b>SERIAL No:</b>	H65234	<b>DATE OF CHART:</b>	12-Oct-2020
<b>EQUIPMENT:</b>	2.00m + 3.47m + 2.50m	<b>SAFETY FACTOR:</b>	59.0%
<b>COMMENT:</b>			

**Komatsu PW160-11**  
**Max Capacity Contours of Radius(m) Plots 2.5m Dipper 3.0m Jib**  
**Level Ground Height 2m Lift JIBLP**  
**Unlocked Road - Tandem Lift**

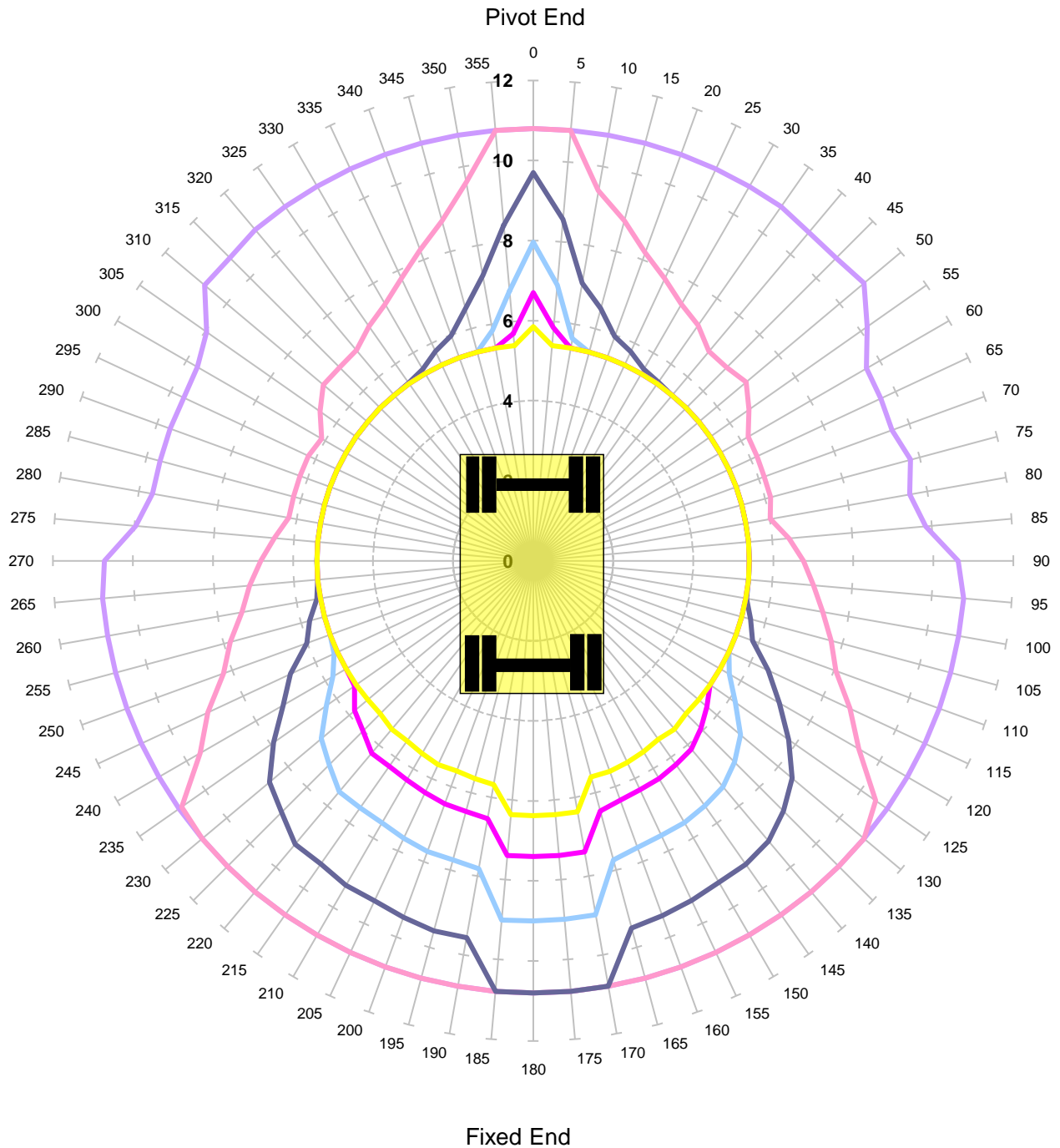

Units in Tonnes

— 0.5 — 1 — 1.5 — 2 — 2.5 — 3

<b>MACHINE &amp; MODEL:</b>	Komatsu PW160-11	<b>REFERENCE:</b>	3.00m Jib
<b>SERIAL No:</b>	H65234	<b>DATE OF CHART:</b>	12-Oct-2020
<b>EQUIPMENT:</b>	2.00m + 3.47m + 2.50m	<b>SAFETY FACTOR:</b>	47.0%
<b>COMMENT:</b>			

**Komatsu PW160-11**  
**Max Capacity Contours of Radius(m) Plots 2.5m Dipper 3.0m Jib**  
**Level Ground Height 2m Lift JIBLP**  
**Locked Road - Tandem Lift**

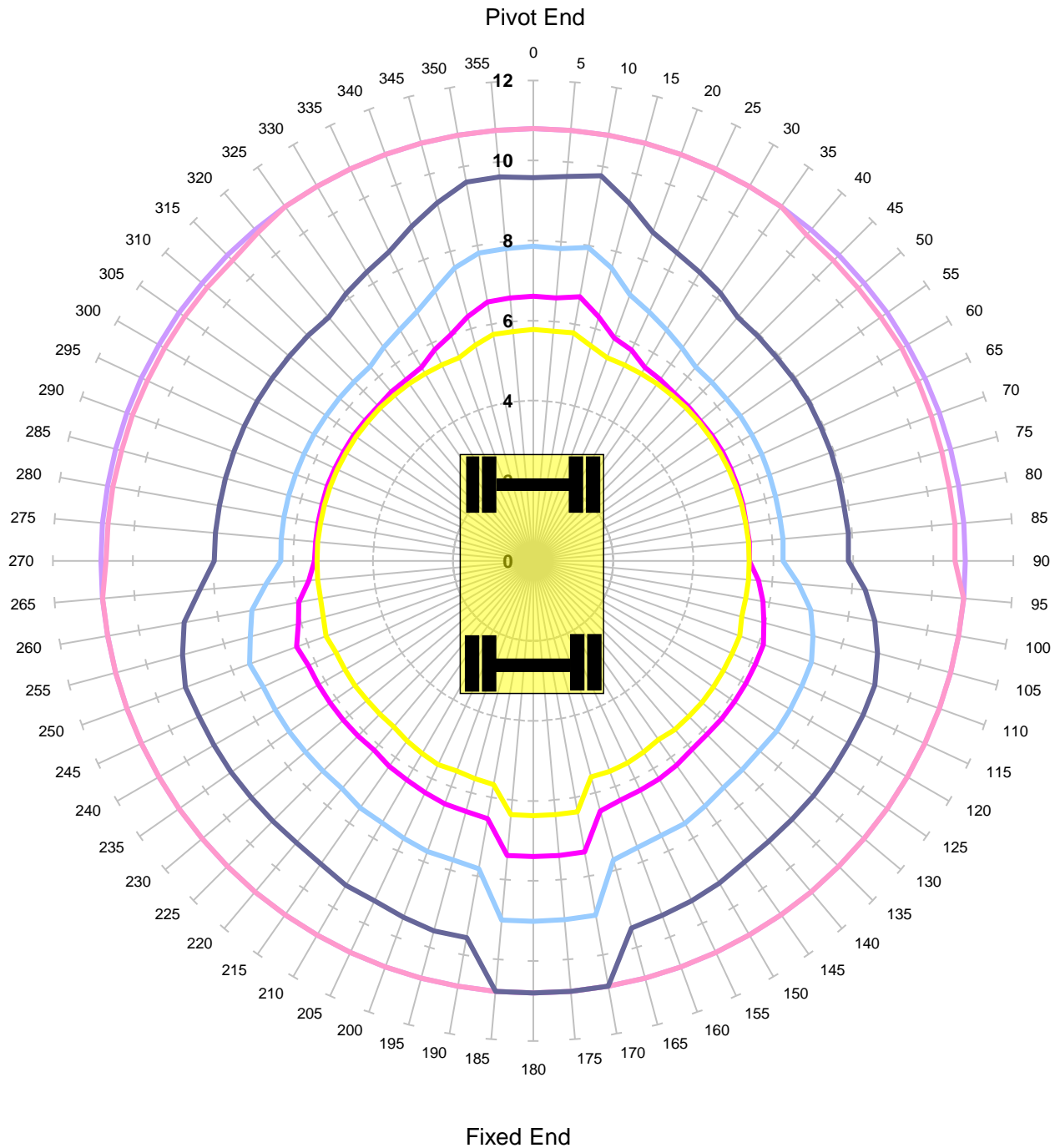

Units in Tonnes

— 0.5 — 1 — 1.5 — 2 — 2.5 — 3

<b>MACHINE &amp; MODEL:</b>	Komatsu PW160-11	<b>REFERENCE:</b>	3.00m Jib
<b>SERIAL No:</b>	H65234	<b>DATE OF CHART:</b>	12-Oct-2020
<b>EQUIPMENT:</b>	2.00m + 3.47m + 2.50m	<b>SAFETY FACTOR:</b>	47.0%
<b>COMMENT:</b>			